



CATALOG 2021

SW-MOTECH®



INTRO

The Company
Team & Events
Partners
Highlights

LUGGAGE

TANK BAGS

PRO tank bags
PRO tank ring
PRO tank bag accessories
ION tank bags
Strap tank bags
Legend Gear tank bags

SADDLEBAGS / SIDE BAGS / SYSBAGS

Blaze saddlebags
Legend Gear side- & saddlebags
SysBags

TAIL BAGS

PRO tail bags
ION tail bags
Legend Gear tail bags
Accessories Legend Gear tail bags
Drybags
Accessories Drybags

ALUMINUM SIDE CASES

TRAX ADV side cases
TRAX ION side cases
TRAX side case accessories

ABS SIDE CASES

AERO ABS side cases
URBAN ABS side cases

SIDE CARRIERS

PRO side carriers
EVO side carriers
SLC side carriers
Side carrier accessories

TOP CASES

TRAX ADV
TRAX ION
Top case accessories
URBAN ABS top cases
SysBags on racks

RACKS

ADVENTURE-RACK
STREET-RACK
ALU-RACK
Other luggage solutions

4 SAFETY

6 Centerstands 162
12 Extensions for side stand foot 164
16 Mirror extensions 166
22 EVO lights 168
Accessories 170

26

PROTECTION 173

30 Crash bars 176
36 Crash pads 180
44 Engine guards 184
46 Handguards & lever guards 190
48 Other protective parts 196

ERGONOMICS 198

57 Footrests 200
58 Extensions for brake pedal 204
62 Gear levers 206
68 Bar risers 208
Seat modifications 212
Cushions 214

NAVIGATION 216

GPS holders 218
T-Lock 220
Navi Case & Phone Case 223
Universal kits 224
Navi Case Pro 226
Further navigation products 227
Power supply 228

GEAR SHOP 230

125

134

149

156

INTRO

HOP ON YOUR BIKE AND
OPEN THE THROTTLE

THE COMPANY	6
TEAM & EVENTS	12
PARTNERS	16
HIGHLIGHTS	22







LIFE IS AN ADVENTURE

2020: AN EXTRAORDINARY YEAR OF CHALLENGES AND ACCOMPLISHMENT

It's 8.23 a.m March 23 2020,: the company's management has just announced that we will be working shortened time hours in the coming weeks. We are all wondering how it will pan out: panic buying, business closures and fear of a disease that no one yet understands. Suddenly, this determines the agenda for Spring 2020 and our medium-sized company is affected by it all. How will we get the goods from our suppliers who are located all over the world? What about trade shows in the weeks ahead? Will anyone still buy motorcycle accessories or is it only toilet paper that is still in demand?

SUCCESSFUL NEW PRODUCTS

Many months have since passed and we have now found answers to those questions: Supply problems were kept under control, and luckily, by the end of March 2020 the new PRO tank bags were already on the ship from Vietnam heading for Europe. Originally, they were going to be sale in May but we made them available in our online store in April and you didn't take long to start snapping them up - online, naturally...

EMERGENCY STOP IN THE SPRING

SEE YOU ONLINE

'Motorräder Dortmund' was our last real trade show. Then everything closed down. It was with heavy hearts that we had to cancel our Open House 2020, just as well as further participation in trade shows. Then we streamed our first online outlet store from the empty factory outlet sales room and used the time to build a beautiful new sales room in Rauschenberg.

BACK ON YOUR BIKE

And as soon as the lockdown was lifted, was no stopping how much everyone was out on their bikes enjoying their long-awaited freedom.

During this time, we gladly supplied you with the suitable accessories. All of a sudden we had more to do than expected. In early summer, short-time working hours came to an end and now, with our new tail bags and other accessories, we can supply you again as usual with the usual high SW-MOTECH quality.

HIGH-TECH INVESTMENT

Despite the crisis in the spring, we purchased a new five-axis milling machine to ensure our current quality and further improve on it. At SW-MOTECH, this is one of our investments in the future. In the midst of great uncertainty, we remained committed to our long-planned purchase and can now offer incredibly precise

milled parts made of aluminum, stainless steel or plastic in large quantities or small batches.

This allows us to react in a flexible way to your needs and to offer add-on components for as many

different motorcycle models as possible. A new motorcycle arrives at our workshop almost every week. We measure every bike in the scanner and develop the prototypes by hand for the suitable side carriers, tank rings, centerstands, crash bars, footrests and many other add-on components.

BOLDLY HEADING INTO THE NEXT BEND



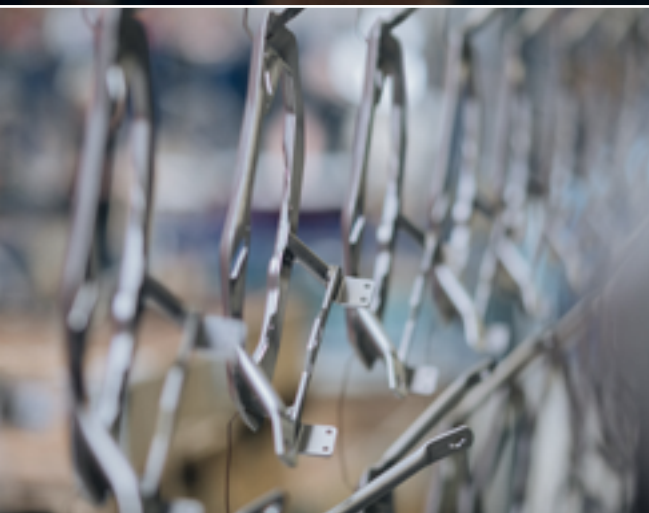

Premium hard parts come into existence only with the interaction of years of experience, design and development in direct conjunction with motorcycles and the employment of modern technology.

EVERYTHING IS TESTED

Each and every bag model is also tested on the bike itself. This way, we can tell you with certainty which luggage system is appropriate for your bike. Simply select your bike model in our online store and you can be assured that all the products shown will fit your bike. The rest is left to personal preference. We now offer add-on component parts and luggage solutions for over 700 different motorcycle models.

SMALL SERIES- LARGE SERIES

The prototypes for all the large metal components happens in our Vojkovico factory in the Czech Republic. It's there that the steel and aluminum add-on components are developed and produced. This happens in batches as small as 25 pieces for bikes such as the Indian Scout Sixty or in huge batches for top sellers such as the BMW GS or Yamaha MT-07. The new milling machine in Rauschenberg supplies the small parts such as EVO footrests, brake pedal enhancements or mirror extensions.

CONCENTRATED EXPERTISE

Before a SW-MOTECH product reaches you, you can be sure it has passed through many hands and incorporates the know-how of over 300 highly qualified staff. In the CAD program and 3D printer the first designs and samples are conceived, material tests must be passed, products are stitched, bonded, welded or machined, transported by ship, train or truck, small additional parts are included in the package, instruction manuals are compiled, photos of the bike and texts are produced, your order is recorded and then securely packed and sent on its way to you.



In 2020 we were in demand in many different areas. 30% more packages sent than last year which speaks for itself.

NEW COLLEAGUES

That's a lot of work - and in 2020, the hygiene specifications and supply issues have brought additional challenges for us as well. That's why we haven't only invested in the most modern machines but we've also invested in new colleagues. It was for this reason only that we were able to send 30% more packages than the previous year.

THANK YOU EVERYONE

2020 has tested our production and supply chain processes to their limits and we thank you for your patience during any shipping delays. The winning reviews of the new PRO tank bags and the tried and tested TRAX ADV aluminum cases in the magazine, 'Motorrad', as well as the great

demand this year show us that we are on the right path. Thank you for your trust in our products.

WE WILL STAY IN TOUCH

So what's next? How can we stay in touch, without large trade shows and with hygiene rules which will likely be in place for a while longer? We have redesigned our showroom in Rauschenberg to accommodate new hygiene restrictions and we hope you will visit us there soon. But we have also developed new ways for us to engage with you.

Here you will find everything that fits your bike and we will give you tips for the right equipment. Located in the middle of Hessen, Rauschenberg is perfectly suited to a motorcycle tour with a pit stop at the outlet store.



Experience our products first hand: this is now possible in our newly designed sales room in Rauschenberg - either on-site or live stream online.

VIRTUAL 360 DEGREE SHOWROOM

But many of you don't live in Germany and come from all corners of the globe. For all of these customers we have brought the sales room into the digital space. Your smartphone or computer is your ticket to our 360-degree store. This way, you can move around the store in all directions and view the products from all angles and in full detail.

With a single click you can learn interesting facts about the bags and add-on components displayed, and if you wish to experience more, then you can open a chat and we will be glad to help you. And of course, you can also buy everything on the virtual store.

Please visit our new virtual showroom at www.sw-motech.digital

We are ready for 2021 and hope to be able to welcome you in person here in Rauschenberg at one of the factory outlets, online at the virtual store or at other events. Ride safely and enjoy every bend!

**VISIT US - EITHER
ONLINE OR IN
PERSON**





HOW TO REACH US

Do you have questions, suggestions or other feedback? Our sales team will gladly help you. You can reach us by telephone, email or you can ask questions on Facebook. We are here for you!

MONDAY TO FRIDAY FROM 8.00 A.M

TELEPHONE +49 (0) 6425 / 8168-050

OR EMAIL

INFO@SW-MOTECH.COM

360° AROUND THE CLOCK

Would you like to visit us? Now it's easy in our virtual showroom. Maybe you have already been in our factory outlet or at our Open House and know our sales room which we have now newly designed and digitalized.

You can move around as you wish and look at the products with ease - from all angles and up close as well as getting all the necessary related information. If you have any questions you can use the chat so we can help you further. Simply click and shop.

WWW.SW-MOTECH.DIGITAL



LEARN MORE

With our videos you can get to know the SW-MOTECH products better. We explain how to install the side carriers, bags and protective products. A short video sometimes makes it a whole lot easier.

On our YouTube channel you can also find our partners' videos as well as videos about our events.

We also regularly present our products and exciting guests on YouTube and Facebook.

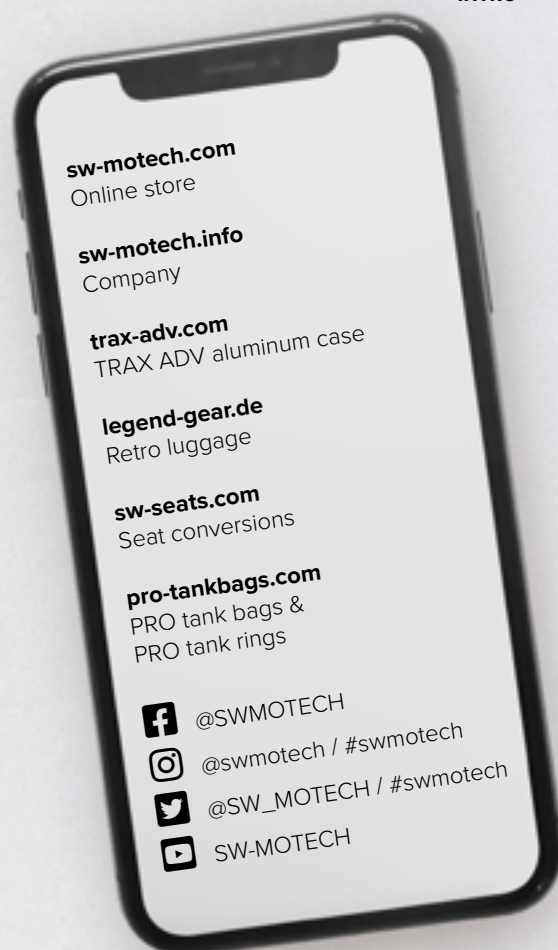

CONNECTED AND IN CONTACT

In our SW-MOTECH Facebook Community, friends and fans share information on travel, motorcycles and the right accessories. Often members find the right answers among themselves as they know our products so well and use them so much. That pleases us, and so thank you for your participation!

There is something new almost daily from SW-MOTECH on Facebook, Instagram and Twitter. We give product tips, report from our motorcycle travels and provide updated information on important events such as factory outlets, live videos and prize drawings.

Maybe appearing soon in your newsfeed?!

ON THE ROAD 2021

In autumn 2020, when this catalog was produced, unfortunately no one could say with certainty if and when trade shows would take place in 2021. However, we knew for sure back then that even without big trade shows, we would still like to meet you. Meeting you in person is very important for us as it enables us to learn more about your product needs and answer your questions directly.

There's a lot going on online these days, and we're doing everything we can to make sure we're easy to reach online with our online store, the new digital showroom and our social networking activities. But there is nothing like an in-person conversation. That's why we're coming to you. To this end, we have built a rolling exhibition booth that will go on tour in 2021 and welcome you at events or dealer events.

Featuring our latest product innovations and fully-equipped demo bikes, the SW-MOTECH trailer is rolling through the country, accompanied by our colleagues, who will be available to answer all your questions on site.

You can find more about the SW-MOTECH trailer's tour dates on our website and, of course, on Facebook and Instagram.

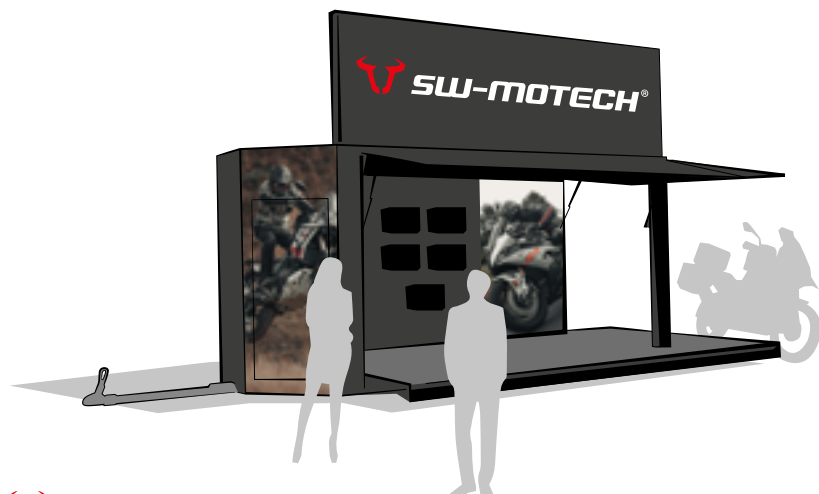

THE BEST EVENTS BY FAR.

If we can't come to you, then you can come to us – provided that hygiene restrictions allow it. That's why we have already set some dates for 2021 when our popular factory outlet events will take place. We have designed the space according to the current hygiene restrictions, and you are cordially invited to join us.

FACTORY OUTLET

13.03.2021
10.07.2021
09.10.2021

08.05.2021
11.09.2021

Each event will have exciting offers, fellow motorcyclists to meet, knowledgeable SW-MOTECH employees and sausages from the grill, as always.

**WE LOOK FORWARD TO YOUR VISIT TO
RAUSCHENBERG!**

OPEN²⁰ HOUSE²¹

„NIGHT OF THE JUMPS“

PRESENTATIONS

SHOPPING AREA

FACTORY TOUR

TEST RIDES

JUNE 11.–13.
RAUSCHENBERG

[sw-motech.com/openhouse](https://www.sw-motech.com/openhouse)



LET'S BIKE TOGETHER

TYROL – DOLOMITES – GROSSGLOCKNER



MOTORCYCLE FUN IN THE SEXIEST REGIONS OF THE ALPS...

... is the motto when it comes to hunting for curves around the "Let's bike together" hotels. The LBT biker hosts will not only show you the most beautiful passes and alpine roads, but will also share with you insider tips from their respective regions – small wonder, as each of them has years of experience in the saddle.



MOTORRAD-HOTEL.COM



For 25 years now, the biker-hosts of the LBT Group with their hotels have stood for amazing motorcycle fun in the Alps. This is not least because the hoteliers themselves are enthusiastic bikers and know what those who love curves expect from a successful motorcycle holiday.

First of all, there are the unbeatable passes in Tyrol, the Dolomites and the Grossglockner region. Guaranteed fun along with twisties until the cows come home. Whether Grossglockner's High Alpine Road, Stelvio Pass or Sellaronda – all these and an incredible variety of other fascinating alpine roads beckon from just beyond the hotel's driveway.

The hosts who love their curves and their

dumplings prove their experience as motorcycling hosts, and they can recommend so many insider roads – including plenty of places to grab a bite, of course.

Naturally, all bike-related services are also exemplary. Motorcycling services that leave nothing to be desired, from a covered parking space, clean-up area and small workshop to the possibility of renting a motorbike. It goes without saying that, in addition to accompanied tours, there are also maps and GPS downloads for days of excellent touring.

Do we need to mention that the quality of the hotels leaves nothing to be desired?

Just check out www.motorrad-hotel.com. There you'll find detailed hotel descriptions, many tour suggestions and wonderful portraits of the biker hosts.





MOHO
MOTORBIKE HOTELS

MoHo - Motorbike Hotels

**LIFE CAN BE
FULL OF FUN!**

www.moho.info/en



55 hotels in
Austria | Italy | Germany | Switzerland
Slovenia | Croatia

MOTORCYCLE LAND CARINTHIA

UNLIMITED MOTORCYCLE FUN

Carinthia, Austria's southernmost province, offers ideal conditions for motorcyclists with its varied landscape and the incomparable backdrop of mountains and lakes. The mild climate is almost perfect for anyone who wants to enjoy the landscape: from Austria's highest mountain, the Großglockner, to one of the numerous swimming lakes with water so clean you can drink it.

Whether it's extensive day tours on winding mountain roads, romantic panoramic routes with breathtaking views or leisurely tours around lakes – Carinthia leaves nothing to be desired for bikers. The particularly good road conditions, excellent signage and fast help in an emergency give motorcyclists a feeling of safety while touring

Located at the crossroads of the Germanic, Slavic and Latin worlds, you can reach Italy from Carinthia in no time at all for breakfast, have lunch in Slovenia and enjoy the famous Carinthian Alps-Adriatic cuisine again at dinner. Cross-border tours offer boundless freedom on two wheels – and all in one day.

ARGE MOTORRADLAND CARINTHIA

The 22 "standard" or "premium" member companies of the Motorradland Carinthia co-op fulfill motorcycle-specific criteria such as hotel infrastructure specially designed for motorcyclists (e. g., covered and lockable parking space, heated drying room, tools, spare parts and material for maintenance), personal attention from the host (the host is usually a motorcyclist himself), detailed maps or toll discounts for Carinthia's mountain passes.

The Carinthia "Panoramastrassen Ticket" is

available exclusively at Motorradland Carinthia Hotels. Grossglockner High Alpine Road, Nockalm Road, Villach Alpine Road, Goldeck Panorama Road and Malta High Alpine Road are included in this ticket. A ticket consists of four sections, each street corresponds to one section (exception: Grossglockner High Alpine Road comprises two sections). With a VIP price of €41.50, you can save up to €12.50 or 23% compared to the cumulative toll rates on the roads.

Carinthia's most beautiful motorcycle tours are summarized in a tour map, described in detail, and they whet your appetite for a ride with many impressive pictures. The tours can also easily be viewed, downloaded and printed out at www.motorrad.kaernten.at. They are also available as GPS data. A 40-minute DVD of images called "Motorradland Kärnten" is also available as well as a separate travel magazine with detailed tour descriptions and lots of background information on culinary, cultural and historical aspects.



MOTORRAD.KAERNTEN.AT

WE HAVE DEVELOPED

QUITE A LOT.

Sometimes it's a bit like Q's lab in a James Bond movie when you walk through the R&D department. Time and again, people are surprised and excited about what engineers and designers are developing in their CAD programs and with their 3D printers.



PRO TANK BAGS

The test winner in the tank bag category (MOTORRAD issue 11/20) delighted countless customers worldwide in 2020. If you haven't got one, you want one. The simple yet secure interaction between the tank bag and tank ring is simply great. That's it.

> **MORE FROM PAGE 36**

NOW ALSO WATERPROOF

We now have two convincing answers (at least, we're convinced) to questions our customers keep asking: When will SW-MOTECH make completely waterproof tank bags?

The PRO Yukon WP fits the PRO tank ring like the other tank bags in the series.

The PRO Enduro WP strap tank bag is the right solution for any bikes without enough room for a tank ring.

> **MORE ON PAGE 43 & 53**





PRO BLAZE

Since their launch in 2010, BLAZE saddlebags with removable support arms have been a popular solution for luggage transport on sporty bikes. They impress with their sporty look, low weight and a patented mounting system. The newest version of the PRO BLAZE with fixed side walls and a new design is available as of this year.

> **MORE STARTING ON PAGE 58**



PRO TAIL BAGS

The new PRO tail bags are the logical continuation of the PRO series in design and function: ballistic nylon and dimensionally stable EVA material paired with the newly developed lashing hooks make the bags robust, practical and good-looking companions on the tail.

> **MORE FROM PAGE 74**



LEVER GUARDS

An eye-catcher and protective product at the same time: the shapely lever guards made of black anodized aluminum are usually at home in racing, but they look great on sport bikes or naked bikes.

› **MORE ON PAGE 192**



AXLE CRASH PADS

A small protective piece that has already saved many pilots a lot of money. The discreet pads made of fiberglass-reinforced plastic protect fork feet and rear axles from major damage with flying colors.

We made the small parts even more resistant and at the same time more attractive – the axle sliders now feature a red bull logo and damping plastic coating.

› **MORE ON PAGE 182**





EXTENSION FOR BRAKE PEDAL

A small component that has great effect. The extension is also a two-stage increase that provides additional control over the brake pedal when driving in a standing position. We manufacture the bike-specific assist for a selection of important travel enduros.

› **MORE ON PAGE 206**



PHONE CASE / NAVI CASE

The new GPS case (horizontal) was developed to fit the latest GPS devices from well-known manufacturers such as Garmin. The phone case (vertical) provides a secure hold for smartphones in the cockpit.

› **MORE ON PAGE 223**

LUGGAGE

SUITABLE FOR YOUR TRIP
AND YOUR BIKE.

Cruiser or dual-sport, ice cream parlor or Sahara – we offer the right luggage solution for every machine. Choosing the right luggage with the proper fitment is everything. Your motorcycle handles better, your gear is protected, organized and your overall travel experience is simply better.



TANK BAGS

> more on page 30



SADDLEBAGS/SIDE BAGS/SYSBAGS

> more on page 56



TAIL BAGS

> more on page 72



ALU SIDE CASES

> more on page 106

**ABS SIDE CASES**

> more on page 118

**SIDE CARRIER**

> more on page 124

**TOP CASES**

> more on page 134

**RACK**

> more on page 148

MOLLE

With the introduction of the PRO series, MOLLE is now an integral part of SW-MOTECH soft luggage systems. What exactly does MOLLE mean and what are its advantages?

The acronym MOLLE stands for MODular Lightweight Load-carrying Equipment and describes a carrying system originally designed for military use for attaching bags and equipment. We've taken the advantages of this tried and tested system, added additional functions and thus made our motorcycle luggage even more flexible and individually adaptable.

The result is relatively simple: SW-MOTECH bags equipped with MOLLE systems allow you to attach a wide range of accessory bags. Whether it's a small Smartphone Drybag or the new PRO Plus, whatever you attach here is entirely up to you.

MOLLE has been integrated into the design of most of our PRO and Legend line of bags, as well as the DryBag 700.

You get the idea, but what can you do with it? Quickly lash on the PRO Plus bag to the PRO Rackpack and now there's plenty of room for your rain jacket. Do you want your navigation app to guide you to your destination today? With the Tablet Drybag on the PRO Sport tank bag, you





have everything in view. Discover the possibilities and be even more flexible in arranging the luggage on your motorcycle.

By the way: it doesn't matter if you put a bag on the MOLLE panel or not. Because MOLLE is not only practical, it also looks sharp on its own.

Our specially developed quick connectors make using MOLLE even easier. With the T-Lock holder you can attach the Smartphone Drybag in no time at all. Using the MOLLE system doesn't require a quick connector, though. Using standard MOLLE attachments provides a very secure hold. You can find out which attachment best suits your needs in the respective article descriptions and mounting instructions.



TANK BAGS

Our tank bags are designed to perfectly fit motorcycles of many different sizes and shapes. Depending on the model, you can choose between our patented tank rings and classic strap or magnetic fasteners.

PRO TANK BAGS	36
PRO TANK RING	44
PRO TANK BAG ACCESSORIES	46
ION TANK BAGS	48
STRAP TANK BAGS	52
LEGEND GEAR TANK BAGS	54



SIMPLY BETTER.

Additional development of our tank bags has been based on feedback and suggestions from our customers. The newest generation, the PRO series has been on the market since April 2020 and the feedback so far tells us that we've hit the mark. Customers want them and the trade press has showered the bags with positive feedback. MOTORRAD magazine even awarded the PRO Daypack „Test Winner“ in their large tank bag comparison.

The PRO line offers elegant and timeless design in conjunction with durable materials and sophisticated product features: Ballistic nylon material protects the luggage against shocks, wind and weather. On the top, we have added laminated EVA material. This gives the bags a distinctive shape and, in conjunction with a MOLLE attachment, ensures a secure fit for the new smartphone and tablet mounts.

Always by your side: thanks to their easy handling, PRO tank bags are a practical companion even during breaks.





Small luggage can be stowed away quickly and easily. Accessory bags and mesh compartments simplify having to divide your luggage and the respective volume expansion ensures even more flexibility.



ION, EVO or PRO. Tank ring systems that work. And if your model can't utilize a tank ring, many tank bag models are available in strap or magnet versions.

We are also adding two new waterproof models: The PRO Yukon WP and PRO Enduro WP.

Choose your favorite from 16 different tank bag models, place it on the matching tank ring and hit the road. So simple and yet so good.

With 16 different models to choose from, there's a tank bag perfect for every ride.



TANK BAGS AT A GLANCE

FOR PRO TANK RING

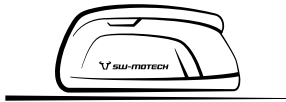

PRO MICRO

> more on page 36

BC.TRS.00.110.30000 79.83 €

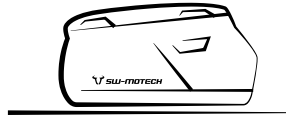

PRO DAYPACK

> more on page 37

BC.TRS.00.108.30000 113.45 €

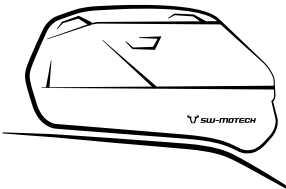

PRO ENGAGE

> more on page 38

BC.TRS.00.107.30000 126.05 €

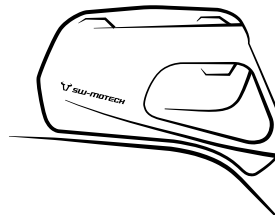

PRO CITY

> more on page 39

BC.TRS.00.104.30000 159.66 €

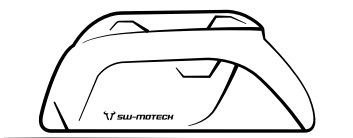

PRO SPORT

> more on page 40

BC.TRS.00.101.30000 163.87 €

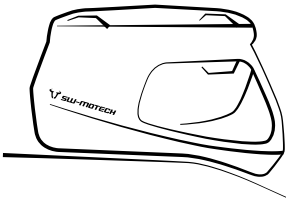

PRO TRIAL

> more on page 41

BC.TRS.00.102.30000 168.07 €

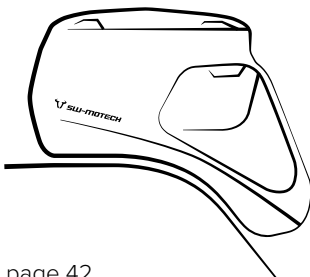

PRO GS

> more on page 42

BC.TRS.00.103.30000 184.87 €

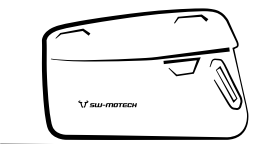

PRO YUKON WP

> more on page 43

BC.WPB.00.022.10000 126.05 €

FOR ION TANK RING

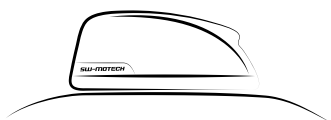

ION ONE

> more on page 48

BC.TRS.00.201.10001

84.03 €

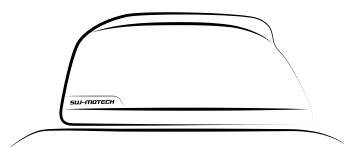

ION TWO

> more on page 49

BC.TRS.00.202.10001

109.24 €

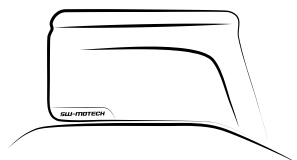

ION THREE

> more on page 50

BC.TRS.00.203.10001

117.65 €

MAGNETIC TANK BAGS



LT 1

> more on page 54

75.63 €

STRAPS- TANK BAGS

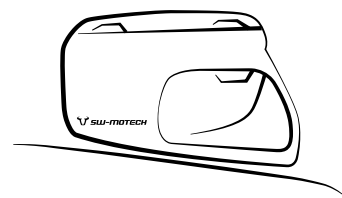

PRO ENDURO TANK BAGS

> more on page 52

BC.TRS.00.112.30000

126.05 €

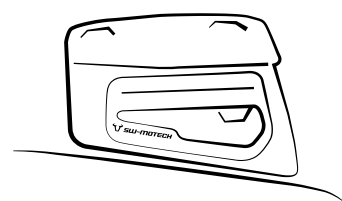

PRO ENDURO WP

> more on page 53

BC.WPB.00.023.10000

147.06 €

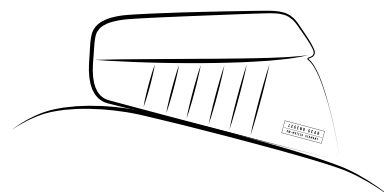

LT 2

> more on page 55

BC.TRS.00.402.10000

92.44 €

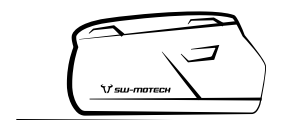

PRO DAYPACK MAGNET

> more on page 37

BC.TRS.00.111.30000

113.45 €



PRO MICRO

Subtle and linear: The PRO Micro fits on almost any tank and securely transports small necessities like vehicle documents and valuables. Like all PRO tank bags, the Micro sits on an EVA plastic base that guarantees it will keep its shape. With the help of a zipper, the volume of the tank bag can be expanded.

INCLUDED IN DELIVERY

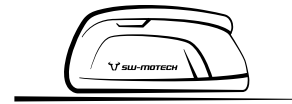
PRO Micro tank bag, PRO top ring, rain cover PRO Micro, mounting material



 3 – 5 l  27.0 x 20.5 x 11.0 cm  800 g

PRO Micro tank bag **BC.TRS.00.110.30000** **79.83 €**

Will it fit your motorcycle? Use the bike filter on sw-motech.com

REQUIRED FOR MOUNTING:

The matching PRO tank ring is required for mounting onto the tank.

Only compatible with the PRO tank ring.

> more on page 44



MATERIAL

- Tank bag top and bottom made of laminated and dimensionally stable EVA material
- Made from durable, highly UV-resistant 1680D ballistic nylon with water resistant interior coating

FUNCTION

- Volume expansion by zipper from 3 to 5 liters
- The patented PRO tank ring gives PRO tank bags a secure hold
- Magnetic guide aid in the PRO tank ring for easy attachment
- Pre-assembled top ring guide rail for ergonomic adjustment of the tank bag
- MOLLE attachment made of stable hypalon material on the top for smartphone and tablet holders
- Reflective details for greater visibility in traffic
- Mesh compartments in the interior
- Weather protection with the supplied rain cover
- Robust carrying handle
- Cable feed-through on the front and rear
- Can be used with a cable lock or anti-theft protection



Small but mighty: the PRO Micro on a Honda CB 650 R



The Smartphone Drybag is sold separately as an accessory



PRO DAYPACK

The universal fit makes the PRO Daypack tank bag a real all-rounder, just like the PRO Micro. However, the Daypack offers more storage with 5 to 8 liters. The Daypack is also available as a magnetic tank bag for use on steel tanks.

INCLUDED IN DELIVERY

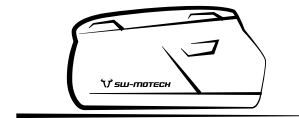
PRO Daypack tank bag, PRO top ring, rain cover PRO Daypack, mounting material



 5 – 8 l  29.5 x 22.5 x 12.5 cm  1,000 g

PRO Daypack tank bag **BC.TRS.00.108.30000** **113.45 €**

PRO Daypack magnetic tank bag **BC.TRS.00.111.30000** **113.45 €**

Will it fit your motorcycle? Use the bike filter on sw-motech.com

REQUIRED FOR MOUNTING:

The matching PRO tank ring is required for mounting onto the tank.

> more on page 44

The PRO Daypack magnetic tank bag is attached directly onto a steel tank (no tank ring required).



MATERIAL

- Tank bag top and bottom made of laminated and dimensionally stable EVA material
- Made from durable, highly UV-resistant 1680D ballistic nylon with water resistant interior coating

FUNCTION

- Volume expansion by zipper from 5 to 8 liters
- The patented PRO tank ring gives PRO tank bags a secure hold
- Magnetic guide aid in the PRO tank ring for easy attachment
- Pre-assembled top ring guide rail for ergonomic adjustment of the tank bag
- MOLLE attachment made of stable hypalon material on the top for smartphone and tablet holders
- Reflective details for greater visibility in traffic
- Mesh compartments in the interior
- Weather protection with the supplied rain cover
- Robust carrying handle
- Cable feed-through on the front and rear
- Can be used with a cable lock or anti-theft protection



Easy attachment thanks to the magnetic guide



PRO ENGAGE

The PRO Engage is perfect for use on curved fuel tanks. Like all PRO tank bags, the PRO Engage is made of robust and particularly UV-resistant 1680D ballistic nylon with a splashproof inner lining.

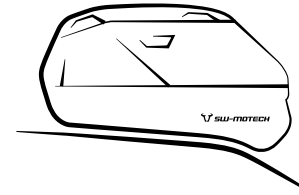

INCLUDED IN DELIVERY

PRO Engage tank bag, PRO top ring, rain cover PRO Engage, mounting material



 7 – 10 l  35.0 x 26.5 x 20.0 cm  1,100 g

PRO Engage tank bag **BC.TRS.00.107.30000** **126.05 €**

Will it fit your motorcycle? Use the bike filter on sw-motech.com

REQUIRED FOR MOUNTING:

The matching PRO tank ring is required for mounting onto the tank.

Only compatible with the PRO tank ring.

> more on page 44



MATERIAL

- Tank bag top and bottom in laminated, dimensionally stable EVA material
- Made from durable, highly UV-resistant 1680D ballistic nylon with water resistant interior coating

FUNCTION

- Volume expansion by zipper from 7 to 10 liters
- The patented PRO tank ring gives PRO tank bags a secure hold
- Magnetic guide aid in the PRO tank ring for easy attachment
- Pre-assembled top ring guide rail for ergonomic tank bag adjustment
- MOLLE attachment made of stable hypalon material on the top for smartphone and tablet holders
- Reflective details for greater visibility in traffic
- Mesh compartments in the interior
- Weather protection with the supplied rain cover
- Robust carrying handle
- Cable feed-through on the front and rear
- Can be used with a cable lock or anti-theft protection



Ideal for steeply sloping fuel tanks: the PRO Engage on the BMW F900 XR



The tank bag is detached from the tank ring using the pull cord

PRO CITY

The PRO City was developed for adventure bikes and other motorcycles with steeply sloped fuel tanks. Although the tank bag offers storage up to 14 liters, the narrow shape won't interfere with your bars, even when the bag is fully packed. Two outer pockets provide additional storage.

INCLUDED IN DELIVERY

PRO City tank bag, PRO top ring, rain cover PRO City, mounting material

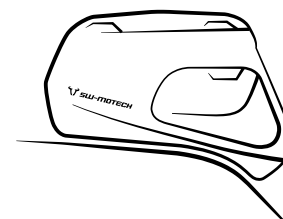

 11 – 14 l  37.0 x 29.5 x 25.0 cm  1,300 g

PRO City tank bag **BC.TRS.00.104.30000** **159.66 €**

Will it fit your motorcycle? Use the bike filter on sw-motech.com

REQUIRED FOR MOUNTING:

The matching PRO tank ring is required for mounting onto the tank.

Only compatible with the PRO tank ring.

> more on page 44



MATERIAL

- Tank bag top and bottom in laminated, dimensionally stable EVA material
- Made from durable, highly UV-resistant 1680D ballistic nylon with water resistant interior coating

FUNCTION

- Volume expansion by zipper from 11 to 14 liters
- 2 outer pockets
- The patented PRO tank ring gives PRO tank bags a secure hold
- Magnetic guide aid in the PRO tank ring for easy attachment
- Pre-assembled top ring guide rail for ergonomic tank bag adjustment
- MOLLE attachment made of stable hypalon material on the top for smartphone and tablet holders
- Reflective details for greater visibility in traffic
- Mesh compartments in the interior
- Weather protection with the supplied rain cover
- Robust carrying handle
- Cable feed-through on the front and rear
- Can be used with a cable lock or anti-theft protection



Two outer pockets for better luggage division

PRO SPORT

The PRO Sport is the perfect choice for sport motorcycles, thanks to its striking design and flat shape. With 12 - 17 liters, this tank bag has plenty of storage. Navigation, smartphones and tablets can be securely attached to the lid of the MOLLE system using the T-Lock holder.

INCLUDED IN DELIVERY

PRO Sport tank bag, PRO top ring, rain cover PRO Sport, mounting material

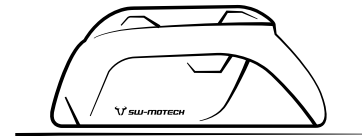

12 – 17 l 39.5 x 31.5 x 16.5 cm 1,400 g

PRO Sport tank bag BC.TRS.00.101.30000 163.87 €

Will it fit your motorcycle? Use the bike filter on sw-motech.com

REQUIRED FOR MOUNTING:

The matching PRO tank ring is required for mounting onto the tank.

Only compatible with the PRO tank ring.

> more on page 44



MATERIAL

- Tank bag top and bottom in laminated, dimensionally stable EVA material
- Made from durable, highly UV-resistant 1680D ballistic nylon with water resistant interior coating

FUNCTION

- Volume expansion by zipper from 12 to 17 liters
- 2 outer pockets
- The patented PRO tank ring gives PRO tank bags a secure hold
- Magnetic guide aid in the PRO tank ring for easy attachment
- Pre-assembled top ring guide rail for ergonomic adjustment of the tank bag
- MOLLE attachment made of stable hypalon material on the top for smartphone and tablet holders
- Reflective details for greater visibility in traffic
- Mesh compartments in the interior
- Weather protection with the supplied rain cover
- Robust carrying handle
- Cable feed-through on the front and rear
- Can be used with a cable lock or anti-theft protection



PRO TRIAL

The PRO Trial is a great companion for long-distance touring. With its open volume expansion, the tank bag features 18 liters of storage and is particularly suitable for use on slightly curved fuel tanks. Two outer pockets provide additional storage.

INCLUDED IN DELIVERY

PRO Trial tank bag, PRO top ring, rain cover PRO Trial, mounting material

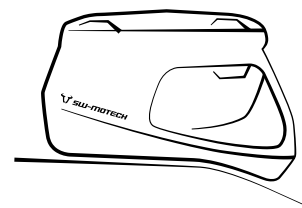

13 – 18 l 37.0 x 31.0 x 24.0 cm 1,600 g

PRO Trial tank bag BC.TRS.00.102.30000 168.07 €

Will it fit your motorcycle? Use the bike filter on sw-motech.com

REQUIRED FOR MOUNTING:

The matching PRO tank ring is required for mounting onto the tank.

Only compatible with the PRO tank ring.

> more on page 44



MATERIAL

- Tank bag top and bottom in laminated, dimensionally stable EVA material
- Made from durable, highly UV-resistant 1680D ballistic nylon with water resistant interior coating

FUNCTION

- Volume expansion by zipper from 13 to 18 liters
- 2 outer pockets
- The patented PRO tank ring gives PRO tank bags a secure hold
- Magnetic guide aid in the PRO tank ring for easy attachment
- Pre-assembled top ring guide rail for ergonomic adjustment of the tank bag
- MOLLE attachment made of stable hypalon material on the top for smartphone and tablet holders
- Reflective details for greater visibility in traffic
- Mesh compartments in the interior
- Weather protection with the supplied rain cover
- Robust carrying handle
- Cable feed-through on the front and rear
- Can be used with a cable lock or anti-theft protection



The PRO Trial is the perfect companion for longer tours



Anti-theft protection for the zipper is possible



PRO GS

The PRO GS was specifically developed for steeply sloping fuel tanks like the BMW R 1250 GS. The stable tank bag offers up to 20 liters of generous storage space. Equipped with the MOLLE system for holding the smartphone or tablet holder, the PRO GS is the perfect companion for long journeys.

INCLUDED IN DELIVERY

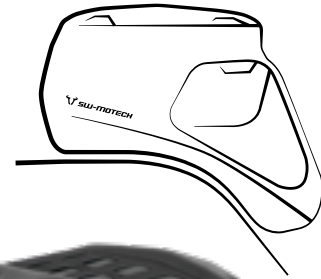
PRO GS tank bag, PRO top ring,
rain cover PRO GS, mounting material



 16 – 20 l  42.0 x 34.0 x 30.0 cm  1,500 g

PRO GS tank bag **BC.TRS.00.103.30000** **184.87 €**

Will it fit your motorcycle? Use the bike filter on sw-motech.com

REQUIRED FOR MOUNTING:

The matching PRO tank ring is required for mounting onto the tank.

Only compatible with the PRO tank ring.

> more on page 44



MATERIAL

- Tank bag top and bottom in laminated, dimensionally stable EVA material
- Made from durable, highly UV-resistant 1680D ballistic nylon with water resistant interior coating

FUNCTION

- Volume expansion by zipper from 16 to 20 liters
- 2 outer pockets
- The patented PRO tank ring gives PRO tank bags a secure hold
- Magnetic guide aid in the PRO tank ring for easy attachment
- Pre-assembled top ring guide rail for ergonomic adjustment of the tank bag
- MOLLE attachment made of stable hypalon material on the top for smartphone and tablet holders
- Reflective details for greater visibility in traffic
- Mesh compartments in the interior
- Weather protection with the supplied rain cover
- Robust carrying handle
- Cable feed-through on the front and rear
- Can be used with a cable lock or anti-theft protection



PRO YUKON WP

The waterproof Yukon WP offers all the advantages of the PRO series and protects your luggage from rain and splashing water in any weather. The overlapping lid made of dimensionally stable EVA material is firmly welded to the TPU body. By welding the two plastics, the materials are seamlessly and firmly joined together - dust and water don't stand a chance.

In stores starting early 2021.

INCLUDED IN DELIVERY

PRO Yukon WP, PRO top ring, mounting material

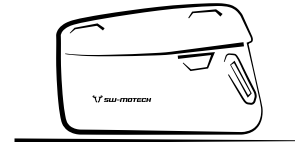

6 l 30.0 x 22.0 x 19.0 cm 1,200 g

PRO Yukon WP tank bag **BC.WPB.00.022.10000** **126.05 €**

Will it fit your motorcycle? Use the bike filter on sw-motech.com

REQUIRED FOR MOUNTING:

The matching PRO tank ring is required for mounting onto the tank.

Only compatible with the PRO tank ring.

> more on page 44



MATERIAL

- Top and bottom in laminated, dimensionally stable EVA material
- Welded body made of TPU plastic without seams

FUNCTION

- Waterproof tank bag with 6 liters of storage
- The patented PRO tank ring gives the tank bag a secure hold
- Magnetic guide aid in the PRO tank ring for easy attachment
- Pre-assembled top ring guide rail for ergonomic adjustment of the tank bag
- Overlapping lid prevents water from entering
- Lid secured magnetically
- MOLLE attachment made of stable hypalon material on the top for smartphone and tablet holders
- Inner pocket with elastic loops and compartments
- Clear compartment for smartphone or maps in inner lid
- Sealed zippers
- Robust and lockable metal zipper
- Reflective details for greater visibility in traffic
- Robust carrying handle
- Can be used with a cable lock or anti-theft protection





CLICK.

THE PRO TANK RING

With the PRO tank ring we have made the best system even better. It combines the advantages of a mechanical snap lock with those of patented magnet technology.

Almost as if by magic, the small but powerful guide magnets direct the piece of luggage exactly to the right place. Then the spring mechanism snaps shut and the upper ring engages with a clearly audible snap. Now the lower ring securely holds the tank bag in any situation, at high speeds on the highway as well as when driving through rough terrain.

THE PRO TOP RING

At the request of many customers, we have significantly improved the positioning of the top ring: The movable top ring is already pre-assembled on the tank bag with a guide rail and does not need to be drilled.

This way, the patent pending upper ring can be individually aligned on the guide rail on the underside of the tank bag. Once the right position has been found, the top ring is screwed tight. When changing to another motorcycle, the position of the upper ring can be adjusted accordingly.



PRO QUALITY FOR ALL

We feel the PRO tank bag and tank ring system is the most practical system on the market. To make it available for as many riders as we can, we have designed a PRO tank ring for over 770 models and counting.



ACCESSORIES

PRO TANK BAGS

SMARTPHONE DRYBAG

The waterproof Smartphone Drybag fits every PRO tank bag. The holder's plastic case with clear PVC window and inner dimensions of 160 x 80 mm is suitable for almost all conventional smartphones up to 6.5 inches.

The Smartphone Drybag can be fastened to the tank bag's MOLLE system using the T-Lock holder. Once the T-Lock holder is fitted, the Smartphone Drybag can be released with a quarter turn when needed. This way the device can be removed in just one step.

BC.TRS.00.152.30000

16.81 €



PRO POCKET

The PRO Pocket accessory bag is perfectly suited to transporting your valuables and travel accessories with its one liter volume. And it's also extremely versatile as it can be attached to all tank bags and tail bags in the PRO range.

The built-in mesh compartments on the top and bottom improve the bag's practicality and a fastening strap with snap hook for keys is also included. The MOLLE attachment on the upper part enables the attachment of additional accessory bags.

BC.TRS.00.153.30000

33.61 €

MORE INFO ON THE T-LOCK HOLDER

This allows you to attach accessory bags quickly and easily to the MOLLE system.

> more on page 221



TABLET DRY BAG

The waterproof Tablet Drybag is the perfect transport solution for maps and tablets on the PRO tank bags: with two supporting arms the Tablet Drybag is inserted into the MOLLE system and additionally secured to the tank bag with a rubber strap.

The tablet itself is waterproof in the plastic case with a large clear PVC window. Thus almost all devices with conventional dimensions can be used with the Tablet Drybag on your motorcycle for navigation. Alternatively, the Tablet-Drybag can also be used for conventional road maps.

BC.TR5.00.151.30000

21.01 €



ANTI-THEFT SYSTEM

This anti-theft kit offers a dual protection system: a security pin prevents the removal of the tank bag from the inside, and the included cable lock secures the tank bag from the outside.



TRT.00.640.20001

16.81 €

ION ONE



The compact ION one tank bag is suitable for almost all tank shapes and is perfect for short tours. If 5 liter storage is not enough, the volume can be almost doubled with the circumferential zipper.

The ION tank bags impress with their unmistakable design and are a cost-effective alternative to the Premium tank bags in the PRO series.

INCLUDED IN DELIVERY

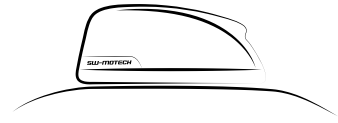
ION one tank bag, ION top ring, rain cover, mounting material



 5 – 9 l  30.0 x 21.0 x 15.0 cm  700 g

ION one tank bag

BC.TRS.00.201.10001

84.03 €

Will it fit your motorcycle? Use the bike filter on sw-motech.com

REQUIRED FOR MOUNTING:

For installation on the tank, the matching ION tank ring is required. Not compatible with other tank rings.

> more on page 51



MATERIAL

- Durable, UV-resistant 600D polyester with water-resistant inner lining
- High form stability due to EVA plastic base and padding

FUNCTION

- Volume expansion by zipper from 5 to 9 l
- Universal, compact shape, suitable for almost every tank
- Individual mounting of the included ION top ring for best fit
- Mesh compartment on the inside
- Integrated map holder that also supports the touch function of digital devices
- Reflective details for more safety in traffic
- Pull strap for releasing the QUICK-LOCK mechanism is secured with a snap fastener
- Practical carrying handle
- 1 splash-proof cable feed-through
- Rain cover with clear PVC window included in delivery



Volume expansion from 5 to 9 liters



Inner mesh compartment

ION TWO

The ION two tank bag is a winner with its universal shape. Thanks to its flat base it looks especially good on sports bikes. For extra storage, the volume can be increased from 13 to 20 liters. Navigating with a map, smartphone or GPS? No problem, because the material of the integrated map holder also enables the use of touchscreen devices.

INCLUDED IN DELIVERY

ION two tank bag, ION top ring, rain cover, mounting material

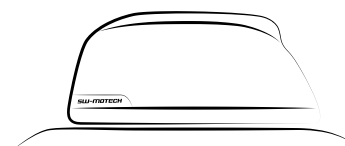

 13 – 20 l  38.0 x 26.0 x 17.0 cm  1,000 g

ION two tank bag **BC.TRS.00.202.10001** **109.24 €**

Will it fit your motorcycle? Use the bike filter on sw-motech.com

REQUIRED FOR MOUNTING:

For installation on the tank, the matching ION tank ring is required. Not compatible with other tank rings.

> more on page 51



MATERIAL

- Durable, UV-resistant 600D polyester with water-resistant inner lining
- High form stability due to EVA plastic base and padding

FUNCTION

- Expand the volume from 13 to 20 l using the zippers
- Individual installation of the included ION top ring for the best fit
- Mesh compartments in the interior
- Space for external DIN A4 map holder, tablet or Smartphone Drybag
- Reflective details for more safety in traffic
- Pull strap for releasing the QUICK-LOCK mechanism is secured with a snap fastener
- Practical carrying handle
- 1 splash-proof cable feed-through
- Rain cover with clear PVC window included in delivery



The pull strap is secured with a push button



Embroidered SW-MOTECH silver-gray bull

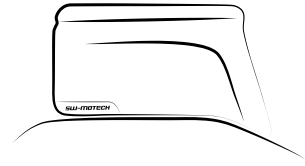

ION THREE

Just the thing for long tours! The ION three tank bag is a real storage wonder, whose already generous 15 liter volume can be expanded to 22. The shape of its underside perfectly hugs lightly curved fuel tanks - and yet thanks to the ION tank ring it does not touch the tank. The material of the integrated map holder also enables the use of touchscreen devices. The ION three tank bag also has a Velcro® patch and D-rings for attaching an optional map holder in DIN-A4 format.



INCLUDED IN DELIVERY

ION three tank bag, ION top ring, rain cover, mounting material

 15 – 22 l  38.0 x 33.0 x 19.0 cm  1,300 g

ION three tank bag **BC.TRS.00.203.10001** **117.65 €**

Will it fit your motorcycle? Use the bike filter on sw-motech.com

REQUIRED FOR MOUNTING:

For installation on the tank, the matching ION tank ring is required. Not compatible with other tank rings.

> more on page 51



MATERIAL

- Durable, UV-resistant 600D polyester with water-resistant inner lining
- High form stability due to EVA plastic base and padding

FUNCTION

- Volume expansion with zipper from 15 to 22 liters
- Individual mounting of the included ION top ring for best fit
- 2 outer pockets, mesh compartments inside
- Space for external DIN A4 map holder, tablet or Smartphone Drybag
- Integrated map holder that also supports the touch function of digital devices
- Reflective details for more safety in traffic
- Pull strap for releasing the QUICK-LOCK mechanism is secured with a snap fastener
- Practical carrying handle
- 1 splash-proof cable feed-through
- Rain cover with clear PVC window included in delivery



Two outer pockets



Integrated map holder on the upper part

ION TANK RING

The ION tank ring, made from fiberglass-reinforced polyamide, provides a secure hold for tank bags in the ION series. The ION tank bag is mounted and locked in place with a single click. The quick-release fastener is then unlocked using the pull strap. The bike-specific design of these tank rings guarantees easy mounting and a secure fit, even for off-road riding.

starting at 12.61 €

MATERIAL & FUNCTION

- Made from fiberglass-reinforced polyamide
- Only for ION tank bags
- Uncomplicated installation to original attachment points in the fuel cap area
- ION tank bag, easily removable for refueling your motorcycle
- Mounting material included in delivery







PRO ENDURO

We cannot offer tank rings for some motorcycle models, but the PRO Enduro strap tank bag impresses with its sophisticated details. When refueling your bike, simply detach the snap buckles and slide or fold the base to the side to gain access to the gas tank. The PRO Enduro strap tank bag fits like a glove on touring motorcycles with sloping fuel tanks.

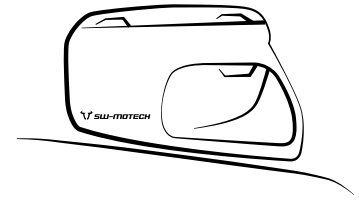
INCLUDED IN DELIVERY

PRO Enduro strap tank bag, waterproof inner bag, Adhesive protective foil



 12 – 15 l  35.0 x 31.5 x 20.0 cm  1,100 g

PRO Enduro strap tank bag

BC.TRS.00.112.30000

126.05 €

Will it fit your motorcycle? Use the bike filter on [sw-motech.com](https://www.sw-motech.com)

TIP:

In order to avoid paint damage, affix the enclosed adhesive protective foil or a tank pad to the upper surface of the tank.

MATERIAL & FUNCTION

- Made from durable, highly UV-resistant 1680D ballistic nylon with water resistant interior coating
- Volume can be increased from 12 to 15 liters via a zipper.
- 2 outer pockets
- Suitable for almost every motorcycle tank, also for High-Enduros with an extremely short tank
- MOLLE attachment made of stable hypalon material on the top for smartphone and tablet holders
- Reflective details for better visibility
- Mesh compartments in the interior
- Weather protection with the supplied rain cover
- Robust carrying handle
- Cable feed-through on the front and rear



PRO ENDURO WP

With this waterproof strap tank bag we meet the demands of numerous customers: in the spacious inner compartment of the PRO Enduro WP the most important travel accessories can be stored. Thanks to the high-quality craftsmanship and the clever welding system, electronic devices and cameras can be transported in any weather conditions.

In stores starting early 2021.

INCLUDED IN DELIVERY

PRO Enduro WP strap tank bag, strap set, adhesive protective foil

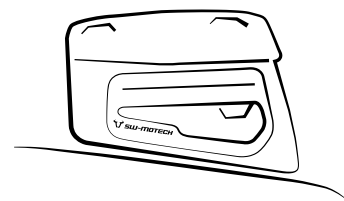

11 l 42.0 x 25.0 x 23.0 cm 1,400 g

PRO Enduro WP strap tank bag **BC.WPB.00.023.10000** **147.06 €**

Will it fit your motorcycle? Use the bike filter on sw-motech.com

TIP:

In order to avoid paint damage, affix the enclosed adhesive protective foil or a tank pad to the upper surface of the tank.

MATERIAL & FUNCTION

- Suitable for many motorcycle tanks.
- Waterproof tank bag with 11 liters of storage
- The top and bottom of the tank bag is made of laminated, shape-retaining EVA material
- Overlapping lid prevents water from entering
- Lid secured magnetically
- Welded body made of TPU without seams
- MOLLE attachment made of stable hypalon on the top for holding accessories like smartphone and tablet mount
- Two outer pockets made of welded hypalon with mesh compartments
- Clear compartment for smartphone or maps in inner lid
- Sealed zippers
- Robust zipper made of metal
- Reflective details for better visibility
- Robust carrying handle
- Underside made of anti-slip material





MAGNETIC TANK BAG LT1

Strong magnets give the tank bag LT1 a strong hold, even on uneven surfaces. Its sophisticated base plate design allows it to be released from the tank without exerting excessive force.

INCLUDED IN DELIVERY

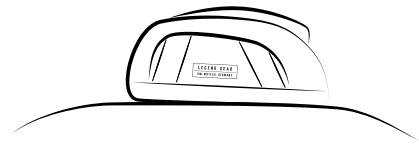
Legend Gear magnetic tank bag LT1, rain cover with clear PVC window
4 fastening straps (strap installation with non-magnetic tanks possible)



 3 – 5.5 l  25.0 x 18.0 x 10.0 cm

Magnetic tank bag LT1	BC.TRS.00.401.10000	75.63 €
Magnetic tank bag LT1-Black Edition	BC.TRS.00.401.10100	75.63 €

Will it fit your motorcycle? Use the bike filter on sw-motech.com

TIP:

In order to avoid paint damage, affix the adhesive protective foil or a tank pad to the upper surface of the tank.

MATERIAL

- Napalon synthetic leather and waxed canvas, water-resistant inner lining
- Coated underside

FUNCTION

- Volume expansion from 3 to 5.5 liters
- Compatible with nearly any steel tank.
- 4 fastening straps for strap installation on non-magnetic tanks
- Weather protection with water-repellent material and waterproof rain cover with clear PVC window
- Robust carrying handle
- Cable feed-through on the front side



Magnetic tank bag LT1 brown/black

STRAP TANK BAG LT2

The compact LT2 tank bag uses classic mounting straps with a modern feature: Two aluminium hooks make it easy to lift the bag and access the gas tank.

INCLUDED IN DELIVERY

Legend Gear strap tank bag LT2, rain cover with clear PVC window, 2 fastening straps

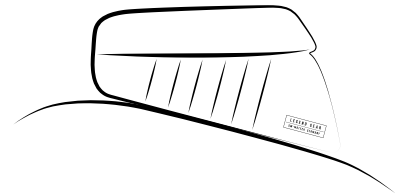

5.5 l 30.0 x 18.0 x 15.0 cm

Strap tank bag LT2 BC.TRS.00.402.10000 92.44 €

Will it fit your motorcycle? Use the bike filter on sw-motech.com

TIP:

Even more bags in classic retro style: you can find more LEGEND GEAR products on pages 62-67 & 94-97



MATERIAL

- Napalon synthetic leather and waxed canvas, water-resistant inner lining
- Coated underside

FUNCTION

- The overlapping lid protects against dirt and moisture.
- Strap for attaching accessory bags
- Weather protection with water-repellent material and waterproof rain cover with clear PVC window
- Robust carrying handle
- Cable feed-through on the front side

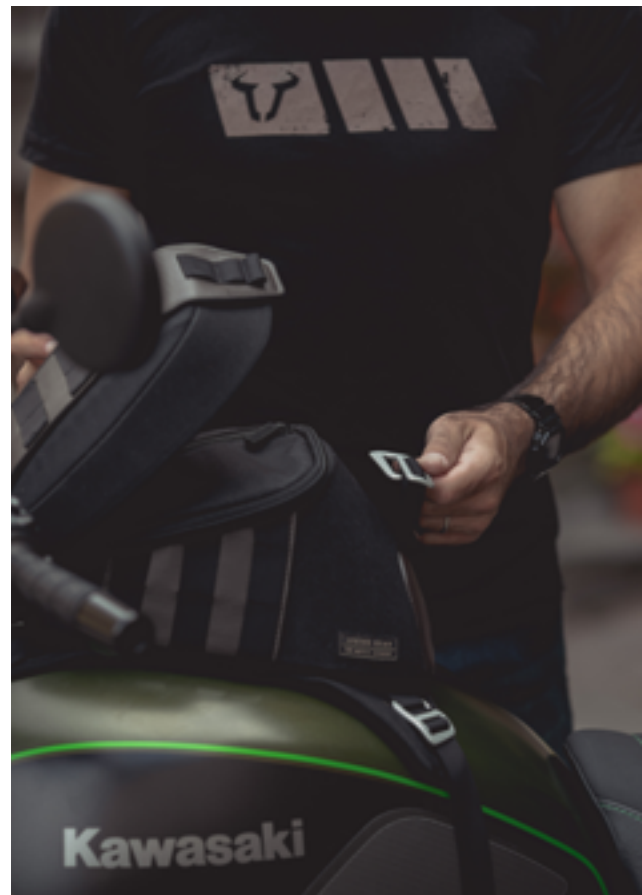



SADDLEBAGS / SIDE BAGS / SYSBAGS

Low weight, simple mounting, high quality workmanship: Our soft luggage systems are the ideal solution for riders who tour often or only occasionally. When traveling without luggage, your motorcycle's overall look is unaffected - this is because our carriers are designed to be very unobtrusive and are also completely removable.

BLAZE SADDLEBAGS **58**

LEGEND GEAR SIDE- &
SADDLEBAGS **62**

SYSBAGS **68**

BLAZE GOES PRO



Since 2010, the BLAZE System has completely rejected the notion that sportbikes can't have high-quality, stable, convenient and great-looking luggage systems. Even the most skeptical sport and naked bike riders are convinced they can enjoy the convenience of a luggage system for commuting or touring when they see the removable support arms and the stable but lightweight cases.

We have completely reworked the BLAZE System for the first time in ten years and focused predominantly on aesthetics and material. The saddlebags now come with a new look, in a rich black and subtle logo details that enhance the style of your motorcycle. The side walls in EVA material lend the bags more stability.



As easy as ever:
The support arms can be easily
clicked into place and just as
easily removed.

Less is more: the bike-specific
support arms are integrated into
the motorcycle's overall look.



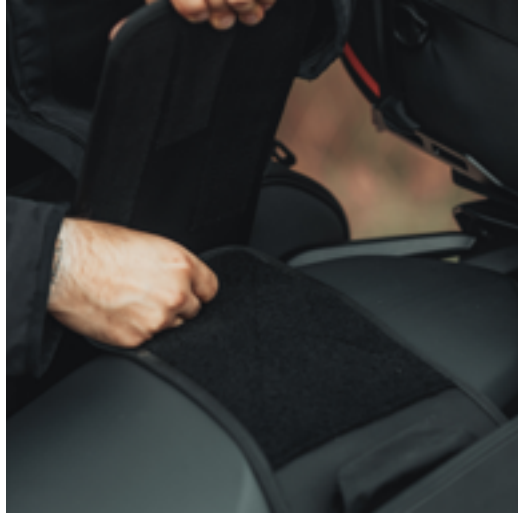

Safety strap with Velcro® ensures
a secure hold



EVA and MOLLE – which sounds like the title of a children's adventure book, are two terms which have now secured a place in the SW-MOTECH world. Usually, these features come with the PRO package. - our premium quality seal for soft luggage.

We now offer a PRO version for our tried and true BLAZE System. This represents the best of all worlds, born of experience over the past 10 years. After using these motorcycle bags on a daily basis, you will learn the real value and capabilities of EVA and MOLLE. However, the most important news is: underlying BLAZE attachment system remains unchanged as there is simply nothing to improve. PRO BLAZE meets the highest demands of a sports luggage system: lightning-fast changeover for journeys and minimal disruption to handling performance. We are looking forward to another fast-paced decade and wish you the best riding experience without compromise.





PRO BLAZE SADDLEBAGS

The PRO BLAZE luggage system features impressive aesthetics, light weight and a clever attachment system. A Velcro® strap is fastened over the passenger seat and bears the weight of the bags, while the support arms provide stability. Developed specifically for sport motorcycles, the stable and aerodynamic saddlebags have minimal effect on handling performance. When traveling without luggage, the bike-specific support arms can be easily removed with only discreet mounting brackets remaining.

INCLUDED IN DELIVERY

2 PRO BLAZE saddlebags, 2 waterproof inner bags, bike-specific mounting kit with 2 support arms, paint protection film

 15 – 20 l  46,0 x 32,0 x 18,0 – 24,0 cm  1,500 g

PRO BLAZE Saddlebags

starting at 294.12 €

Will it fit your motorcycle? Use the bike filter on [sw-motech.com](https://www.sw-motech.com)



TIP:

For motorcycles with higher exhaust pipes, we offer the specially developed BLAZE H variation. Due to the elevated position, the bags are not affected by the heat radiation of the exhaust.

MATERIAL

- Made from durable, highly UV-resistant 1680D ballistic nylon with water resistant interior coating
- Side walls in dimensionally stable, laminated EVA material

FUNCTION

- Removable support arms
- Volume expansion with zipper from 15 to 20 liters
- A high-performance Velcro® strap secures the left and right saddlebag and bears the weight of the luggage
- Main compartment to be loaded from above
- Outer pocket with covered zipper
- MOLLE attachment in strong hypalon material on the front for fastening accessory pouches
- Reflective details for increased visibility
- Practical carrying handle







SIDE BAG LC1/LC2

The LC1/LC2 side bags combine classic looks with contemporary functionality. The bags can be easily mounted and removed from the SLC side carriers thanks to a quick-lock system. Durable Napalon synthetic leather and waxed canvas fabric highlight the vintage design of the Legend Gear soft luggage. The LC1/LC2 side bags are available in a classic-looking two tone Black-Brown or the all-black, Black Edition.

INCLUDED IN DELIVERY

Legend Gear LC1/LC2 side bags, waterproof inner bag



 9,8 l  31,0 x 26,0 x 14,0 cm  1,200 g

Side bag LC1, left	BC.HTA.00.401.10100L	121.85 €
Side bag LC1, left - Black Edition	BC.HTA.00.401.10200L	121.85 €
Side bag LC1, right	BC.HTA.00.401.10100R	121.85 €
Side bag LC1, right - Black Edition	BC.HTA.00.401.10200R	121.85 €

Will it fit your motorcycle? Use the bike filter on sw-motech.com

 13,5 l  31,0 x 35,0 x 14,0 cm  1,400 g

Side bag LC2, left	BC.HTA.00.402.10100L	134.45 €
Side bag LC2, left - Black Edition	BC.HTA.00.402.10200L	134.45 €
Side bag LC2, right	BC.HTA.00.402.10100R	134.45 €
Side bag LC2, right - Black Edition	BC.HTA.00.402.10200R	134.45 €

Will it fit your motorcycle? Use the bike filter on sw-motech.com

MATERIAL & FUNCTION

- Napalon synthetic leather and waxed canvas, water-resistant inner lining
- One- or two-sided mount
- Mix and match. Bags are available as left or right, small or large, brown or black variants
- Quick lock system made of glass fiber reinforced polyamide
- Roll closure and waterproof inner bag provide rain protection

TIP:

Bike-specific SLC-carriers are available for over 230 models. With their compact form they will fit perfectly with the contours of your motorcycle.
> more on page 130



Quick-lock system at the back



Side bag LC2 left in black/brown

LC SIDE BAG SYSTEM

For the very best performance and convenience: The complete package. Before releasing any new luggage application, we determine which configuration(s) best suit a specific motorcycle model. Our bike-specific luggage systems account for variations such as exhaust systems and tail section design to present you the best possible combination of Legend Gear LC1 and LC2 side bags for your particular motorcycle. Some may even have one bag, usually to accommodate high exhausts.

INCLUDED IN DELIVERY

Legend Gear side bag(s) LC, waterproof inner bag(s)
SLC side carriers, mounting material



LC side bag system

starting at 189.08 €

Will it fit your motorcycle? Use the bike filter on sw-motech.com

TIP:

Find the right system with the bike filter on the SW-MOTECH online store: simply enter your motorcycle, model and model year and you'll see what fits your bike.

FUNCTION

- The right set for each bike – for one or both sides and with bags in different sizes, even suitable for bikes with high exhaust
- Bike-specific development of the SLC side carrier for best fit
- Available for one or both sides depending on tail shape
- Simple mounting - all required parts are included in the set





Classic retro looks for your bike

SADDLEBAG LS1/LS2

These elegant bags can be easily attached to the SLS saddle strap and impress with their exceptional design. Available in two different sizes, the saddlebags can be mounted on one or both sides and can be combined with accessory bags.

INCLUDED IN DELIVERY

Legend Gear saddlebag LS1/LS2, waterproof inner bags, 2 fastening hooks, 2 license plate straps, 2 fastening straps

 9,8 l  31,0 x 26,0 x 14,0 cm  1,050 g

Saddlebag LS1 **BC.HTA.00.401.10000** 105.04 €

Will it fit your motorcycle? Use the bike filter on sw-motech.com

 13,5 l  31,0 x 35,0 x 14,0 cm  1,300 g

Saddlebag LS2 **BC.HTA.00.402.10000** 117.65 €

Will it fit your motorcycle? Use the bike filter on sw-motech.com

MATERIAL & FUNCTION

- Napalon synthetic leather and waxed canvas, water-resistant inner lining
- Holding straps and safety straps with aluminum hooks enable secure and flexible fastening to the SLS saddlebag holder
- Converts to a very practical messenger-style shoulder bag in combination with the LA4 shoulder strap
- Waterproof inner bag included in delivery

SLS SADDLE STRAP

The SLS saddle strap provides secure grip for the LS1/LS2 saddlebags on straight bench saddles with a passenger seat. The elegant saddlebags from the Legend Gear series lend a special touch to Cafe Racers, Retro and Street Bikes.

 39,0 x 21,0 cm

SLS Saddle strap **BC.HTA.00.403.10000** 42.02 €

Will it fit your motorcycle? Use the bike filter on sw-motech.com

MATERIAL & FUNCTION

- Napalon synthetic leather
- Simple mounting by looping the SLS saddle strap support straps under the seat



BEST BUY SHOULDER STRAP:

With the LA4 shoulder strap you can easily transport your luggage when you're on the go. The quick, easy-to-use fastening hooks attach to any of the Legend Gear tank bags, sidebags or tail bags.

> more on page 97

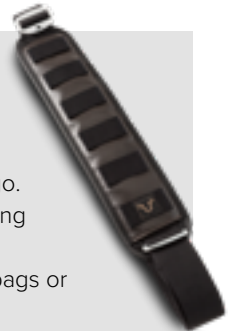





SIDE BAGS LH1/LH2

The stylish LH side bags combine the weight advantages of a soft bag with the stability advantages of a hard case. The classic diamond-tuck Legend gear look combines with high-tech materials and a modern, locking fastening system. This allows the bags to be mounted onto the fender strut with the turn of a hand via an integrated lock mechanism on the SLH side carrier. When riding without luggage, the motorcycle only shows unobtrusive fixing points.

INCLUDED IN DELIVERY

System: Legend Gear side bag(s) LH, support element(s), key, mounting material



 19,5 l  42,0 x 28,0 x 24,0 cm  2,400 g

Side bag LH1 **BC.HTA.00.682.11000** **235.29 €**

Will it fit your motorcycle? Use the bike filter on sw-motech.com

 25,5 l  47,0 x 39,0 x 24,0 cm  3,100 g

Side bag LH2 **BC.HTA.00.682.10000** **252.10 €**

Side bag system LH **starting at 310.92 €**

Will it fit your motorcycle? Use the bike filter on sw-motech.com

REQUIRED FOR MOUNTING:

The bike-specific SLH side carrier is mounted on the original attachment points of the fender strut. The Legend Gear side bag LH is easily installed and removed thanks to a quick-lock system



MATERIAL

- Robust & easy to clean: Made from weather- and UV-resistant 600D polyester and grained artificial leather
- Excellent form stability thanks to ABS plastic rear panel and top as well as PE-reinforced sides

FUNCTION

- Abundant storage: 25.5 liters (left) / 19.5 liters (right)
- LH2 features the MOLLE system for fastening accessory bags
- Integrated anti-theft protection on the inside of the bag is activated with a quarter turn, additional anti-theft protection from lockable bag lid
- Pocket handle allows convenient carrying
- For Harley-Davidson models: combining with original Harley-Davidson accessories (Sissy bars, racks) is possible



Dimensionally stable ABS plastic top



Unobtrusive SLH side carrier









SYSBAGS

The jack-of-all-trades system. Sportbikes, standards, dual-sports... commuting, day trips or RTW touring, the SysBag is our most versatile luggage solution. The SysBag series consists of only three bags but nevertheless offers more than 20 mounting options and combination possibilities. Each bag can be lashed to the tail, side or mounted to the carrier with a quick release fastener. Or in combination with each other. The SysBags combine low weight and sturdiness, versatility and thought-out details.



INCLUDED IN DELIVERY

SysBag, 4 loop straps with SysBag hooks, shoulder strap, waterproof inner bags, 4 rubber bungs for the eyelets at the back of the bag, 2 license plate straps (SysBag 10/15), paint protection film

 10 l	 32,5 x 13,0 x 26,0 cm	 700 g		
SysBag 10	BC.SYS.00.001.10000		75.63 €	
SysBag 10 with adapter plate			117.65 €	
 15 l	 32,5 x 15,5 x 36,5 cm	 900 g		
SysBag 15	BC.SYS.00.002.10000		84.03 €	
SysBag 15 with adapter plate			134.45 €	
 30 l	 48,5 x 23,5 x 33,5 cm	 1,700 g		
SysBag 30	BC.SYS.00.003.10000		100.84 €	
SysBag 30 with adapter plate			151.26 €	

Will it fit your motorcycle? Use the bike filter on sw-motech.com

TIP:

SysBags are available individually or with adapter plate for mounting on side carriers or luggage racks. SysBag systems include bags, adapter plates and bike-specific side carriers.

MATERIAL

- Made of Ballistic Nylon, with double PU internal coating for better weather protection
- Back that is gentle on paintwork with anti-slip coating

FUNCTION

- Robust and versatile soft luggage for all kinds of adventures
- Usable as a side bag or tail bag
- Mounting via adapter plate with just one click on the side carrier or rack (depending on the model)
- Can be lashed to the bike's tail end with the loop straps provided
- Overlapping cover with mesh pocket inside, two zipped compartments on the front
- Roll closure with the possibility of attaching the removable, waterproof inner pocket





SYSBAG 10/15 ON THE SLC SIDE CARRIER

Attaching the SysBag via the adapter plate with quick-release fastener is very convenient. The SysBag 10/15 can be locked to the bike-specific SLC side carrier with a single hand movement. Depending on the model of bike you can combine bags of different sizes or mount the carrier on just one side.

The SLC side carrier is suitable for combining with SysBag 10 or SysBag 15 with adapter plate. Systems tailored to the tail geometry are also available: Either including a left and/or right side carrier or with one or two bags in the optimal size.

Need even more storage? Then add an additional SysBag onto the rack for carrying more luggage – whether tied down or with the appropriate adapter plate, everything is possible (racks from page 148).



Adapter plate with quick-release fastener for attaching to an SLC side carrier



Removable, waterproof inner bag



Overlapping lid and color-coded functional elements

SYSBAG 15/30 FOR PRO/EVO SIDE CARRIERS

With the removable PRO and EVO side carriers the bike is ready for the journey in no time. Just click on a SysBag 15 or SysBag 30 with an adapter plate, attach another bag to the tail, and you'll have plenty of storage for long tours. These two bags are a great alternative to large aluminium cases. They're flexible and retain their shape, whether you're handling them or when coming into contact with other objects and in case of falls.

The PRO side carrier gives the SysBags 15 a secure hold and the SysBags 30 with adapter plate fit PRO as well as EVO (side carriers from page 124). The adapter kit necessary for attachment is supplied for both carrier models. The SysBag 10 with adapter plate is not compatible with these side carriers.

Whether for ADVENTURE-RACK, STEEL-RACK, STREET-RACK – the SysBags 15 will comfortably find their place. The SysBags 30 can also be attached to the ALU-RACK (racks from page 148).



Adapter plate for fastening to
PRO/EVO side carriers

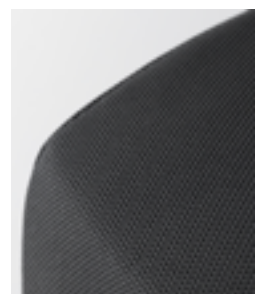

Made from durable 1680D ballistic
nylon material



Secure fastening with plastic
hooks

TAIL BAGS

Easy to mount and extremely versatile: Tail bags are a straightforward and cost-effective luggage solution. We have the right shape for every bike, and each luggage series offers unique features and styling. What suits you, your bike and your next tour? A tail bag from our new PRO series, a simpler ION bag, an all-weather Drybag or do you prefer stylish Legend Gear luggage in a retro look?

PRO TAIL BAGS	74
ION TAIL BAGS	90
LEGEND GEAR TAIL BAGS	94
ACCESSORIES LEGEND GEAR	96
DRYBAGS	98
ACCESSORIES DRYBAGS	105



TIME FOR SOMETHING NEW

For many years, tail bags have been one of the most popular products in our range: they're extremely versatile and we manufacture them in just about every conceivable shape and size.

THE NEW PRO SERIES

The new tail bags from the PRO series are - like the successful PRO tank bags - made of indestructible 1680 D ballistic nylon and match the look of the tank bags.

They also impress with their high-quality workmanship and sophisticated features: reflective attachments ensure better visibility, robust and patented lashing hooks allow you to secure the bags quickly and easily on to the motorcycle and a MOLLE system on the top lets you attach accessory bags. More information about the MOLLE system can be found on page 28.



The new patented lashing hooks make things easy for you. You can remove the straps from the bag holders quickly and easily, even when wearing gloves.

Side bags and volume extensions offer even more flexibility.





The small and compact Roadpack is perfect for sporty bikes. It fits everything you need for a day trip.



NEW PATENT

The new patented lashing hooks allow you flexibility when attaching PRO tail bags. The straps are hooked and tensioned in one step. To remove the bag, the strap is released in one easy step and removed from the lashing eyelet by pulling on the drawstring.

The excess strap length can be secured to the strap with a Velcro® fastener. This allows the bag to be used on different motorcycles, and the strap length can be adjusted accordingly. No more flapping straps, and you still have options if you want to use the bag on another motorcycle.

TRULY VERSATILE

Add on bags such as the PRO Pocket, PRO Plus or PRO Tentbag and you have a wide range of options to help organize your gear and expand luggage capacity. Helpers such as the T-Lock make the accessory bags even more convenient to use. You can find out more about the T-Lock on page 220.



PRO TAIL BAG OVERVIEW



PRO ROADPACK

> more on page 78

BC.HTA.00.307.30000

105.04 €



PRO REARBAG

> more on page 80

BC.HTA.00.304.30000

168.07 €



PRO RACKPACK

> more on page 82

BC.HTA.00.305.30000

168.07 €



PRO CARGOBAG

> more on page 84

BC.HTA.00.306.30000

155.46 €



PRO SEAT RING

> more on page 86

TRT.00.787.21500/B

37.82 €



PRO BASE

> more on page 88

BC.HTA.00.309.30000

16.81 €



PRO PLUS

> more on page 88

BC.HTA.00.308.30000

42.02 €



PRO TENTBAG

> more on page 89

BC.HTA.00.350.30000

37.82 €





PRO ROADPACK

The PRO Roadpack is a compact bag that fits perfectly on the tail of small and sporty motorcycles. The volume can be expanded from 8 to 14 liters via the zipper. An inner bag with zipper in the lid offers storage for valuables.

In addition to the enclosed loop straps, two Velcro straps and a slot on the underside enable quick and secure attachment to the seat or rack. The patented lashing hooks allow for flexibility when attaching a tail bag. The straps are hooked and tensioned in one step.

INCLUDED IN DELIVERY

PRO Roadpack tail bag, waterproof inner bag, 4 loop straps with lashing hooks, paint protection film



8 – 14 l 36,0 x 28,0 x 15,0 – 23,0 cm 900 g

PRO Roadpack tail bag BC.HTA.00.307.30000 105.04 €

Will it fit your motorcycle? Use the bike filter on sw-motech.com

MATERIAL

- Top of the bag made of laminated and dimensionally stable EVA material
- Made of durable and highly UV-resistant 1680D Ballistic Nylon with splashproof inner lining
- Underside made of anti-slip material
- MOLLE attachment made of stable Hypalon material on the upper side for attaching accessory bags.

FUNCTION

- Volume expansion in the bottom from 8 to 14 liters
- Universal fit for almost all motorcycles
- Zipper mesh compartment in the lid
- Robust lashing eyelets for secure fastening of the bag at 4 points and for lashing accessory bags
- Reflective details for better visibility
- Zipper management: Elastic loops prevent the zipper pulls from fluttering
- MOLLE attachment made of stable Hypalon material on the upper side for attaching accessory bags.
- Simple and quick attachment of the bag to the motorcycle with loop straps with a patented lashing hook.
- Weather protection thanks to the supplied waterproof inner bag
- Sturdy carrying handle



Designed for the tail of sporty motorcycles



Patented lashing hooks for quick attachment

PRO REARBAG



With its universal fit, the PRO Rearbag is just as suitable for use on street bikes as it is for the passenger seat of an adventure touring machine. With a volume of 22 liters, which can be expanded up to 34 liters, the bag offers ample space for luggage on the passenger seat of your motorcycle.

You can even stow your helmet in the Rearbag. The slightly convex underside adapts to the seat and is equipped with anti-slip material. The patented lashing hooks allow for flexibility when attaching the bag. The straps are hooked and tensioned in one step.

INCLUDED IN DELIVERY

PRO Rearbag tail bag, waterproof inner bag, 4 loop straps with lashing hooks, 2 x lashing eyelets for attachment to the plate holder



 22 – 34 l  40,0 x 43,0 x 25,0 – 37,0 cm  1,800 g

PRO Rearbag tail bag **BC.HTA.00.304.30000** **168.07 €**

Will it fit your motorcycle? Use the bike filter on [sw-motech.com](https://www.sw-motech.com)

TIP:

The PRO Rearbag features a MOLLE Patch on the lid. If you need more storage, you can simply attach an accessory bag, such as the PRO Plus.

> more on page 88



MATERIAL

- Top of the bag made of laminated and dimensionally stable EVA material
- Made of durable and highly UV-resistant 1680D Ballistic Nylon with splashproof inner lining
- Underside made of anti-slip material
- MOLLE attachment made of stable Hypalon material on the upper side for attaching accessory bags.

FUNCTION

- Volume expansion in the top area from 22 to 34 liters
- Universal fit for almost all motorcycles
- Zipper mesh compartment in the lid
- Additional storage thanks to two outer pockets with covered zippers.
- Storage space for a helmet
- Robust lashing eyelets for secure fastening of the bag at 4 points and for lashing accessory bags
- Simple and quick attachment of the bag to the motorcycle with loop straps with a patented lashing hook.
- Reflective details for better visibility
- Zipper management: Elastic loops prevent the zipper pulls from fluttering
- Weather protection thanks to the supplied waterproof inner bag
- Sturdy carrying handle



Mesh compartment under the lid for valuables



Secure velcro strap fastening







PRO RACKPACK

The robust PRO Rackpack was developed specifically for use on racks and is a practical travel bag in combination with the shoulder strap. Combined with the luggage rack extension, it can be easily mounted on the STREET RACK or the ADVENTURE RACK as well as on standard carriers, passenger seat or a sissy bar.

The extensions on both sides of the tail bag allow an expansion of the volume from 32 to 42 liters. The patented lashing hooks allow for flexibility when attaching the bag. The straps are hooked and tensioned in one step.

INCLUDED IN DELIVERY

PRO Rackpack tail bag, waterproof inner bag, 4 loop straps with lashing hooks, shoulder strap, paint protection film

 32 – 42 l  33,0 x 56,0 – 68,0 x 26,0 cm  2,400 g

PRO Rackpack tail bag **BC.HTA.00.305.30000** **168.07 €**

Will it fit your motorcycle? Use the bike filter on sw-motech.com



TIP:

The PRO Rackpack can be securely attached to the rack extension. The large contact surface provides a secure hold.

> more starting from page 148



MATERIAL

- Made of durable and highly UV-resistant 1680D Ballistic Nylon with splashproof inner lining
- Underside made of anti-slip material
- MOLLE attachment made of stable Hypalon material on the upper side for attaching accessory bags.

FUNCTION

- Universal fit for almost all motorcycles
- Large mesh compartment with zipper on the inside of the lid
- Additional storage thanks to two outer pockets with covered zippers.
- Inner mesh compartments with zippers on both outer pockets
- Volume expansions on both outer sides
- Robust lashing eyelets for secure fastening of the bag at 4 points and for lashing accessory bags
- Simple and quick attachment of the bag to the motorcycle with loop straps with a patented lashing hook.
- Reflective details for better visibility
- Zipper management: Elastic loops prevent the zipper pulls from fluttering
- Weather protection thanks to the supplied waterproof inner bag
- Sturdy carrying handle



Storage space for a helmet



A more secure hold on the rack

PRO CARGOBAG

With a volume of 50 liters, the Cargobag is one of the most versatile bags in the PRO tail bag series. The soft bag adapts very well to many different tail designs and offers numerous transport storage solutions on the motorcycle.

Large outer pockets on both sides, which can be compressed with Velcro straps if necessary, make the Cargobag even more adaptable. A large mesh pocket in the lid provides space for small items and bungee tie-downs with straps on the outside support other luggage items.

INCLUDED IN DELIVERY

PRO Cargobag, waterproof inner bag, 4 loop straps, 2 lashing eyelets for attaching to a plate holder, paint protection film

50 l 50,0 x 70,0 x 26,0 – 33,0 cm 1,700 g

PRO Cargobag tail bag BC.HTA.00.306.30000 155.46 €

Will it fit your motorcycle? Use the bike filter on sw-motech.com



TIP:

Accessory bags such as the PRO Tentbag can be attached to the PRO Cargobag.

> more on page 89



MATERIAL

- Made from durable, highly UV-resistant 1680D ballistic nylon with water resistant interior coating
- Underside made of anti-slip material
- MOLLE system made of sturdy Hypalon material on the top for attaching accessory bags

FUNCTION

- Universal fit for almost all motorcycles
- 2 outer pockets with zippers
- 2 exterior bungee tie-downs for additional luggage
- Storage space for a helmet
- Zipper mesh compartment in the lid
- Covered zippers
- Zipper management: rubber straps prevent zipper from flapping
- Reliable 4-point lashing strap attachment
- Reflective details for better visibility
- Weather protection thanks to the supplied waterproof inner bag
- Robust carrying handle



Attaching with sturdy loop straps



Large outer pockets





PRO SEAT RING

The PRO Seat Ring allows you to attach a PRO tank ring to your seat. That means you can enjoy the benefits of the PRO tank ring with its magnetic guide and extremely easy fastening system. This is especially handy when it's not possible to attach a tank ring to the front of the tank.

The PRO tank ring sits on a fiberglass-reinforced plastic plate, which is connected to a rubber pad for a more secure hold. Lashing straps secure the plate to the seat. There are four flat-bottomed PRO tank bags that are compatible with the PRO Seat Ring: PRO Micro, Daypack, Sport and Yukon WP can all be held securely.

INCLUDED IN DELIVERY

PRO seat ring, rubber pad, plastic plate, lashing straps

PRO Seat Ring	TRT.00.787.21500/B	37.82 €
Will it fit your motorcycle? Use the bike filter on sw-motech.com		

MATERIAL & FUNCTION

- Fiberglass-reinforced plastic plate
- To be used on the passenger seat
- For PRO tank bags with a straight bottom



PRO TIP:

Fits with the four PRO tank bags: Micro, Daypack, Sport and Yukon WP

> more on pages 36, 37, 40 & 43



PRO BASE

The PRO Base is the perfect solution for flexibility when transporting small bags on the passenger seat. A MOLLE system panel, made of robust Hypalon material, is sewn onto a ballistic nylon base and can be attached to the seat with the provided lashing straps. To do so, the straps are pulled through the four metal eyelets.

The MOLLE system provides a secure hold for accessory bags such as the PRO Plus or PRO Pocket. These can be looped or attached with a T-Lock.

The advantage of using the T-Lock: the bag can be released with a quarter turn and is quickly accessible.



INCLUDED IN DELIVERY

PRO Base, lashing straps

 16.6 x 24.0 cm

PRO Base	BC.HTA.00.309.30000	16.81 €
----------	---------------------	---------

Will it fit your motorcycle? Use the bike filter on [sw-motech.com](https://www.sw-motech.com)

MATERIAL & FUNCTION



- MOLLE system made of sturdy Hypalon material on the top for attaching accessory bags
- Underside made of anti-slip material
- Versatile use on seats in the passenger area
- Easy attachment with lashing straps

PRO PLUS

The PRO Plus accessory bag features a circumferential zipper and an outer compartment in the lid. You can expand the volume of the bag from three to six liters by expanding the zipper. On the inside of the lid, there is a mesh compartment with zipper for documents and keys. At the bottom of the inner compartment, pens, tools or other small items can be secured using the elastic plastic loops.

INCLUDED IN DELIVERY

PRO Plus accessory bag, waterproof inner bag

 3 – 6 l  28,0 x 21,0 x 7,0 – 12,0 cm  400 g

PRO Plus accessory bag	BC.HTA.00.308.30000	42.02 €
------------------------	---------------------	---------

Will it fit your motorcycle? Use the bike filter on [sw-motech.com](https://www.sw-motech.com)

MATERIAL & FUNCTION

- Additional compartment with zipper on the outside of the lid
- Zipper mesh compartment in the lid
- Elastic loops in the inner compartment for securing small parts
- Bottom part features expandable volume from 3 to 6 liters
- Fits almost all bags from the PRO series and bags from the LEGEND GEAR series with a MOLLE attachment



PRO TENTBAG

The PRO Tentbag tail bag has a capacity of 18 liters and can hold most two-person tents. The tentbag can also be used as additional storage for clothes and other luggage. With the included straps you can easily attach the bag to other large PRO tail bags like the PRO Cargobag.

The PRO Tentbag impresses with its high-quality workmanship and sophisticated features: the patented lashing hooks allow for flexibility when attaching the tail bag. The straps are hooked and tensioned in one step.

INCLUDED IN DELIVERY

PRO Tentbag, 2 straps with 2 lashing hooks each



18 l  17,0 x 58,0 x 17,0 cm  400 g

PRO Tentbag tail bag **BC.HTA.00.350.30000** **37.82 €**

Will it fit your motorcycle? Use the bike filter on [sw-motech.com](https://www.sw-motech.com)

MATERIAL & FUNCTION

- Made of durable and highly UV-resistant 1680D Ballistic Nylon with splashproof inner lining
- Easy attachment with straps and lashing hooks to other PRO tail bags
- Long zipper with cover
- 4 carrying loops
- Capacity for a typical two person tent
- Reflective details for better visibility



A secure hold on the PRO Cargobag



Patented lashing hook attachment



ION S

Ideal for small and sporty bikes: the volume of the ION S tail bag can be expanded from 7 to 15 l using the zipper and offering sufficient storage for drinks, a change of clothes, reflective vest and other small items that are needed on a day trip or short trip.

Two straps with hook-and-loop closure, along with a slot on the underside, enable fast and secure attachment to a seat or rack. Reinforced sides, a padded lid and cinch straps guarantee a stable, secure fit even when you're riding at speed.

INCLUDED IN DELIVERY

ION S tail bag, waterproof inner bag, 4 loop straps, adhesive protective film

 7 – 15 l  29,0 x 10,0 x 33,0 cm  600 g

ION S tail bag **BC.HTA.00.201.10000** **84.03 €**

Will it fit your motorcycle? Use the bike filter on sw-motech.com



MATERIAL

- Durable, highly UV-resistant 600D polyester with water resistant interior coating
- Attractive with the combination of textile fabric made from polyester with black soft vinyl
- Non-slip underside for ideal grip

FUNCTION

- Volume expansion from 7 to 15 l, height varies between 10 and 18 cm
- Compact tail bag, ideal for small and sport bikes
- Reflective details for more safety in traffic
- Subtle design elements: stitched SW-MOTECH logo and bull in silver grey
- D-rings for reliable 4-point attachment with loop straps
- Two integrated flaps with hook-and-loop closure plus slot for attaching under the seat or rack
- Easily accessible: Outer pocket and mesh compartment inside the lid
- Large main compartment for individual loading
- Waterproof inner bag included in delivery
- Practical carrying handle



Volume expansion along the bottom



Mesh compartment with zipper in the lid of the bag

ION M

The ION M tail bag can be attached to nearly any motorcycle tail thanks to its optimized design and the curved, non-slip bottom. It's also possible to use it on the STREET-RACK/ADVENTURE-RACK soft luggage extension.

Especially handy: the tail bag features two outer pockets and a mesh compartment inside the lid. The easy-access 26-liter storage compartment can be expanded to 36 liters by two expanders on the sides, if needed.

INCLUDED IN DELIVERY

ION M tail bag, waterproof inner bag, 4 long loop straps (67 cm), 4 short loop straps (17 cm), 2 straps for attaching to the plate holder, shoulder strap, paint protection film



 26 – 36 l  44,0 x 30,0 x 30,0 cm  1,500 g

ION M tail bag BC.HTA.00.202.10000 109.24 €

Will it fit your motorcycle? Use the bike filter on sw-motech.com

MATERIAL

- Durable, highly UV-resistant 600D polyester with water resistant interior coating
- Attractive with the combination of textile fabric made from polyester with black soft vinyl
- Non-slip underside for ideal grip

FUNCTION

- Volume expansion from 26 to 36 l via two side zippers, width varies from 44 to 54 cm
- Optimized for the passenger seat or tail of many models
- Reflective details for more safety in traffic
- Subtle design elements: stitched SW-MOTECH logo and bull in silver grey
- 4 D-rings for attaching the shoulder strap or additional pieces of luggage
- No flapping, thanks to reinforced sides
- Easy access: 2 outer pockets and mesh compartment inside lid
- Large main compartment for individual loading
- Waterproof inner bag included in delivery
- Practical carrying handle



ION L

With 50 liters of volume, the ION L tail bag offers abundant storage space for longer tours. Tie-down straps compress smaller loads, eliminating flapping and also allow for attachment of additional pieces of luggage.

Durable cam buckles and loop straps enable quick strapping and, along with the flexible shape and anti-slip bottom, give the bag a secure hold on the passenger seat or tail. The carrying handle is another added benefit of the spacious ION L tail bag.

INCLUDED IN DELIVERY

ION L tail bag, waterproof inner bag, 4 loop straps, 2 tie-down straps, 2 straps for attaching to the plate holder, paint protection film



50 l 70,0 x 30,0 x 30,0 cm 1,300 g

ION L tail bag BC.HTA.00.203.10000 117.65 €

Will it fit your motorcycle? Use the bike filter on sw-motech.com

MATERIAL

- Durable, highly UV-resistant 600D polyester with water resistant interior coating
- Attractive with the combination of textile fabric made from polyester with black soft vinyl
- Non-slip underside for ideal grip

FUNCTION

- Volume expansion from 26 to 36 l via two side zippers, width varies from 44 to 54 cm
- Optimized for the passenger seat or tail of many models
- 4 D-rings for attaching the shoulder strap or additional pieces of luggage
- No flapping, thanks to reinforced sides
- Easy access: 2 outer pockets and mesh compartment inside lid
- Large main compartment for individual loading
- Reflective details for more safety in traffic
- Discreet design features: stitched SW-MOTECH logo and bull in silver-gray
- Waterproof inner bag included in delivery
- Practical carrying handle



TAIL BAG LR1

The practical combination of tail bag and full-fledged backpack makes this a versatile companion for every tour – no matter whether on the motorcycle or on foot.

INCLUDED IN DELIVERY

Legend Gear LR1 tail bag, rain cover, 4 loop straps with Legend Gear hooks, 2 straps for attaching to plate holder, adhesive protective film



 17,5 l  30,0 x 17,0 x 40,0 cm

Legend Gear tail bag LR1	BC.HTA.00.404.10000	105.04 €
--------------------------	---------------------	----------

Will it fit your motorcycle? Use the bike filter on [sw-motech.com](https://www.sw-motech.com)

MATERIAL & FUNCTION

- Napalon synthetic leather and waxed canvas, water-resistant inner lining
- Universal fit for seat and tail rack
- Also suitable for bikes with high-mounted exhaust
- Secure hold through 4-point strap mounting
- Converts to a full-fledged backpack with padded, adjustable carrying straps in a few simple steps
- Roll-top closure
- Zippered compartment and padded laptop holder
- Waterproof rain cover



TAIL BAG LR2

This 48 liter tail bag combines the striking styling and functional design of the Legend Gear line with enough storage for extended tours.

The universal fit allows the bag to be attached to a variety of bike models. This bag can also be mounted on bikes with high exhaust systems.

INCLUDED IN DELIVERY

Legend Gear LR2 tail bag, waterproof inner bag, 4 loop straps with Legend Gear hooks, 2 straps for attaching to license plate holder, adhesive protective foil



 48 l  68,0 x 45,0 x 30,0 cm

Legend Gear tail bag LR2 **BC.HTA.00.405.10000** **243.70 €**

Legend Gear tail bag LR2 - Black Edition **BC.HTA.00.405.10100** **243.70 €**

Will it fit your motorcycle? Use the bike filter on [sw-motech.com](https://www.sw-motech.com)

TIP:

Accessory bag LA1 or LA2 can be looped into the MOLLE patches on the top and side.

> more at [sw-motech.com](https://www.sw-motech.com)

MATERIAL & FUNCTION

- Napalon synthetic leather and waxed canvas, water-resistant inner lining
- Non-slip underside
- Secure hold thanks to 4-point strap mounting, tie-down straps are also included in delivery
- Waterproof inner bag



ACCESSORIES

LEGEND GEAR TAIL BAGS

TOOL BAG LA5

This member of the Legend Gear line can function as much more than a tool bag. Carry your wallet, smartphone, and other items with ease.

Thanks to a variety of loop and strapping options, the tool bag can be attached to the handlebar and frame at various points.

MATERIAL & FUNCTION

- Napalon synthetic leather & waxed canvas, water-resistant inner lining, anodized aluminum hooks.
- Can be carried on a belt or used as a shoulder bag
- Included in delivery: shoulder/waist strap and fastening straps in different lengths
- Durable zippers and Velcro® secure bag contents
- Zippered flap pocket
- Padded compartment



 1,6 l  24,0 x 7,0 x 11,0 cm

Legend Gear tool bag LA5

BC.TRS.00.407.10000

50.42 €

Will it fit your motorcycle? Use the bike filter on [sw-motech.com](https://www.sw-motech.com)





SHOULDER STRAP LA4

The Legend Gear shoulder strap LA4 allows you to easily turn any Legend saddlebag, tank bag, or tail bag into a practical shoulder bag.

MATERIAL & FUNCTION

- Padded Legend Gear LA4 shoulder strap provides maximum comfort
- The length of the Legend Gear LA4 shoulder strap can be adjusted from 90cm to 150cm using 2 strap adjusters
- Fastening straps allow you to securely and flexibly attach Legend Gear accessory bags.
- Sturdy fastening hooks made from anodized aluminium

BC.TRS.00.406.10000

21.01 €

BOTTLE HOLDER LA6

The MOLLE compatible Legend Gear LA6 Bottle Holder creates convenient add-on storage of a standard bottle of fuel or water to any SW-MOTECH bag with a MOLLE panel.

MATERIAL & FUNCTION

- Ideal for bottle with a diameter of about 7 cm and a height of about 21 cm (see accessories)
- Velcro features stepless adjustment and makes it possible to attach bottles of slightly different dimensions
- Bottle is additionally secured at the top by an elastic band
- Compatible with LR1 & LR2 tail bags, LR3 messenger bag, LT1 & LT2 tank bags, SLS saddle strap and Legend Gear series SLA tank bag and Drybag 700 tail bag

BC.TRS.00.408.10000

10.08 €



DRYBAGS - OVERVIEW



DRYBAG 700

> more on page 100

BC.WPB.00.021.10000 109.24 €



DRYBAG 600

> more on page 101

67.23 €



DRYBAG 350

> more on page 102

58.82 €



DRYBAG 180/260

> more on page 103

from 42.02 €



DRYBAG 80

> more on page 104

BC.WPB.00.010.10001 50.42 €



DRYBAG STORAGE BAGS

> more on page 105

from 12.61 €





DRYBAG 700

The ultimate weather-proof solution for travellers who need a lot of storage: The Drybag 700 protects up to 70 liters of gear from moisture and dirt. The tail bag's wide end-to-end upper opening enables quick loading and unloading. Additional Drybags can be attached securely via buckles, and the bottom width can be expanded with a zipper. MOLLE panels front and back create additional possibilities for accessories such as the LA6 Bottle Holder.

INCLUDED IN DELIVERY

Drybag 700 tail bag, 4 loop straps, shoulder strap



 70 l  76,0 x 75,0 x 30,0 cm  1,850 g

Drybag 700 tail bag BC.WPB.00.021.10000 109.24 €

Will it fit your motorcycle? Use the bike filter on [sw-motech.com](https://www.sw-motech.com)

MATERIAL & FUNCTION

- Made of durable 500D polyester with double-sided coating
- Universal fit for almost all motorcycles
- Width of the underside adjustable via a zipper
- Easy to combine with other Drybags
- Padded handle
- D-rings enable bags to be pulled down tight on the motorcycle
- Includes 4 loop straps and 1 shoulder strap
- Reflective details



DRYBAG 600

The very practical-sized Drybag 600 makes a great tail bag or everyday use duffel bag. Protecting 60 l of gear from dust and wet weather, the Drybag 600 is easy to clean and can be combined with other Drybag tail bags.

INCLUDED IN DELIVERY

Drybag 600 tail bag, 4 loop straps, shoulder strap



60 l 71,0 x 33,0 x 33,0 cm 1,300 g

Drybag 600 tail bag	BC.WPB.00.002.10001	67.23 €
Drybag 600 tail bag – signal yellow	BC.WPB.00.002.10001/Y	67.23 €

Will it fit your motorcycle? Use the bike filter on sw-motech.com

MATERIAL & FUNCTION

- Made of durable 500D polyester with double-sided coating
- Universal fit for almost all motorcycles
- Width of the underside adjustable via a zipper
- Easy to combine with other Drybags
- Padded handle
- D-rings enable bags to be pulled down tight on the motorcycle
- Includes 4 loop straps and 1 shoulder strap
- Reflective details



Rugged 500D polyester with coating on both sides



Ample storage for long tours

DRYBAG 350

The conveniently-sized Drybag 350 makes a great tail bag or everyday use duffel bag. Protecting 35 l of gear from dust and wet weather, the Drybag 350 is easy to clean and can be combined with other Drybag tail bags.

INCLUDED IN DELIVERY

Drybag 350 tail bag, 4 loop straps, shoulder strap



 35 l  58,0 x 28,0 x 28,0 cm  1,150 g

Drybag 350 tail bag	BC.WPB.00.001.10001	58.82 €
---------------------	---------------------	---------

Drybag 350 tail bag – signal yellow	BC.WPB.00.001.10001/Y	58.82 €
-------------------------------------	-----------------------	---------

Will it fit your motorcycle? Use the bike filter on sw-motech.com

MATERIAL & FUNCTION

- Made of durable 500D polyester with double-sided coating
- Universal fit for almost all motorcycles
- Top roll closure
- 4-point strap attachment
- Comfortable carrying handles
- Easy to combine with other Drybags
- Includes 4 loop straps and 1 shoulder strap
- Also available in Signal Yellow
- Reflective details





DRYBAG 180/260



Weather proof tail and carrying duffel bag in one: These lightweight Drybags are available in two sizes and can be easily attached to the rear rack, passenger seat or other Drybags.

INCLUDED IN DELIVERY

Drybag 180/260 tail bag, 4 loop straps, shoulder strap



 18 l	 39,0 x 25,0 x 18,0 cm	 900 g
Drybag 180 tail bag	BC.WPB.00.018.10000	42.02 €
Will it fit your motorcycle? Use the bike filter on sw-motech.com		

 26 l	 50,0 x 26,0 x 26,0 cm	 1,200 g
Drybag 260 tail bag	BC.WPB.00.020.10000	46.22 €
Will it fit your motorcycle? Use the bike filter on sw-motech.com		

MATERIAL & FUNCTION

- Made of durable 500D polyester with double-sided coating
- Waterproof bag roll-top closure
- Secure four-point attachment, integrated front compartment
- Easy to combine with other Drybags
- Includes 4 loop straps and 1 shoulder strap



DRYBAG 80

The Drybag 80 offers a unique level of versatility: Not only can it be used as a convenient shoulder bag, it can be attached to the Drybag 700, used as a tank bag, a tail bag or a crash bar bag up front.

INCLUDED IN DELIVERY

Drybag 80 tail bag, steering head strap, 2 loop straps, shoulder strap



8 l 19,0 x 9,0 x 35,0 cm 500 g

Drybag 80 tail bag

BC.WPB.00.010.10001

50.42 €

Will it fit your motorcycle? Use the bike filter on [sw-motech.com](https://www.sw-motech.com)

TIP:

The Drybag 80 fits many of the crash bars from the SW-MOTECH range. Select your motorcycle model using the bike filter and find out whether it fits your crash bar.

> more at [sw-motech.com](https://www.sw-motech.com)

MATERIAL & FUNCTION

- Made of durable 500D polyester with double-sided coating
- Multifunctional use as a tail bag, tank bag, crash bar bag or shoulder bag
- Waterproof roll closure



ACCESSORIES

DRYPACK STORAGE BAGS

From water sports on the motorcycle: The waterproof bags can be stowed in luggage as well as lashed separately. For this reason the Drybags have a lug on the base.



 4/8/13/20 l

Drybag storage bag 20 l	BC.WPB.00.016.10000	12.61 €
Drybag storage bag set 4/8/13 l	BC.WPB.00.017.10000	30 €

Will it fit your motorcycle? Use the bike filter on sw-motech.com



ROK™ STRAPS

The tough and long-lasting ROK™ straps are elastic and provide secure hold for luggage. The straps can be fastened almost anywhere and adjusted for length using the buckle.

The straps and hardware have smooth edges to prevent scratches.

ROK™ Straps 2 x 310 - 1,060 mm	BC.ROK.00.711.10000/B	16.81 €
ROK™ Straps 2 x 500 - 1,500 mm	BC.ROK.00.711.10100/B	21.01 €

CABLE LOCK FOR MOTORCYCLE LUGGAGE

Anti-theft protection for when you're on the road: the cable lock helps secure a tank bag or tail bag to the motorcycle. The 180 cm long cable is simply passed through the frame and lock eyelet and then the lock attaches to the zipper and/or D-ring.



BC.LOC.00.002.10100/B	13.45 €
-----------------------	---------



LOCK FOR MOTORCYCLE LUGGAGE

The lock for motorcycle luggage hooks into the zipper eyelets, thus securing the contents of any SW-MOTECH luggage with zipper openings.

BC.LOC.00.001.10200/B	5.88 €
-----------------------	--------



ALUMINUM SIDE CASES

"The TRAX ADV case system excels with its volume, handling and robustness. And is a deserved test winner". This was the conclusion of the magazine MOTORRAD when testing case systems for the BMW R 1250 GS in spring 2020. You can interpret it this way: Ready For Adventure.

TRAX ADV and TRAX ION aluminum cases are reliable companions even under the most extreme conditions. The feedback we get from adventure riders all over the world confirms this year after year. The cases are simply up for any kind of stress. Through any weather, any road conditions or straight through water crossings, TRAX luggage remains unaffected and waterproof.

TRAX ADV SIDE CASES **108**

TRAX ION SIDE CASES **112**

TRAX SIDE CASE
ACCESSORIES **114**

ALUMINUM POWER



Glass fiber-reinforced plastic corner caps give an extra degree of protection in case of ground contact

A ROBUST COMPANION FOR ANY ADVENTURE

No matter if you're on a long or short-distance tour, TRAX side cases are suitable for adventures big and small. In just two movements, they can be attached to the removable PRO or EVO side carriers (from page 128) and can also be secured with a lock. Adapter kits are also available for mounting the case on carriers from other manufacturers.

CASES WITH AN EXTRA DOSE OF CONVENIENCE

The deep-drawn lid is additionally reinforced with beading. Open one side or remove the lid entirely for easier loading. Sturdy aluminium handles make it easy to carry the cases and mount them on the vehicle. In addition, four wide lashing points integrated into the lid design provide a secure hold for additional luggage.



Lashing points integrated into the lid design allow the attachment of a tent or accessory bag

WELL THOUGHT OUT — EVEN IN THE SMALLEST DETAILS

Small features have a big impact: Thanks to a specially designed membrane, the cases can easily be opened even after large changes in pressure and temperature.

The extensive range of accessories completes the attractive offer: lock sets with matching keys, accessory bags and solutions for the interior and exterior, holders for water bottles and fuel canisters, leave nothing to be desired.



WATER AND DIRT DON'T STAND A CHANCE

The robust TRAX ADV side cases are 100% dustproof and waterproof thanks to robot-assisted welding, punch rivet technology and replaceable seals. And every one of our cases has to prove that in our final quality assurance testing.

Embossing on the outside gives TRAX ADV side cases their distinctive look





TRAX ADV

A touring case without compromise: Strength, protection from the elements and ease of use were the focus of the TRAX ADV case development. A practical carrying handle, a completely removable lid, glass fiber reinforced plastic corner caps and a large chamfer for cornering clearance are just some of the smart features. Here, veteran motorcyclists have developed a premium aluminium case that overcomes any challenge.

INCLUDED IN DELIVERY

TRAX ADV side case, lid limiter, storage bag



37 l	49.0 x 37.0 x 23.0 cm	5,100 g
TRAX ADV M – left, black	ALK.00.733.11000L/B	302.52 €
TRAX ADV M – right, black	ALK.00.733.11000R/B	302.52 €
TRAX ADV M – left, silver	ALK.00.733.11000L/S	302.52 €
TRAX ADV M – right, silver	ALK.00.733.11000R/S	302.52 €

Will it fit your motorcycle? Use the bike filter on sw-motech.com

45 l	49.0 x 37.0 x 28.0 cm	5,500 g
TRAX ADV L – left, black	ALK.00.733.10000L/B	310.92 €
TRAX ADV L – right, black	ALK.00.733.10000R/B	310.92 €
TRAX ADV L – left, silver	ALK.00.733.10000L/S	310.92 €
TRAX ADV L – right, silver	ALK.00.733.10000R/S	310.92 €

Will it fit your motorcycle? Use the bike filter on sw-motech.com

MATERIAL

- Sturdy and watertight side case made from aluminium
- Protection against oxidation and abrasion with powder coating (black model) or anodising (silver model)

FUNCTION

- Large cutaways on outer corners for plenty of ground clearance for cornering, additional protection from glass fiber reinforced plastic corner caps
- Robot-guided welding and self-piercing riveting keeps out the wet
- Even when loaded, the lid is completely removable with the quick-release fastener
- 4 large tie-downs integrated into the cover design allow for external lashing of an accessory bag, tent or other gear
- High strength and stability thanks to the embossed patterns, welded edges and pre-installed retaining rail
- Hinges made from stainless steel, handles made from anodized aluminium
- Exchangeable cover gasket

REQUIRED FOR MOUNTING:

- Side cases (from page 124)
- Adapter kit (page 132)
- TRAX lock set (page 117)



The PRO side cases provide secure support for the side case



The lid can be opened on one side or completely removed

TRAX ION

Robust lightweights: TRAX ION side cases step up with their high-quality workmanship made of 1.5 mm thick aluminum and are available in 37 l and 45 l versions. Thanks to their cornering-friendly shape with large cutaways, the cases are faithful companions for journeys of all kinds – and at an attractive price.

INCLUDED IN DELIVERY

TRAX ION side case, storage bag



37 l 49.0 x 37.0 x 23.0 cm 4,700 g

TRAX ION M – left, black ALK.00.165.11001L/B 260.50 €

TRAX ION M – right, black ALK.00.165.11001R/B 260.50 €

Will it fit your motorcycle? Use the bike filter on sw-motech.com

45 l 49.0 x 37.0 x 28.0 cm 5,200 g

TRAX ION L – left, black ALK.00.165.10001L/B 260.50 €

TRAX ION L – right, black ALK.00.165.10001R/B 260.50 €

Will it fit your motorcycle? Use the bike filter on sw-motech.com

MATERIAL

- Sturdy and watertight side case made from aluminium
- Protection against oxidation and abrasion with powder coating

FUNCTION

- Large chamfer on sides for plenty of ground clearance for cornering, additional protection from glass fiber reinforced plastic corner caps
- Robot-guided welding and self-piercing riveting keep out the wet
- 4 lashing strap eyes on the lid for lashing on an additional waterproof accessory bag (page 115)
- Theft protection: Case lid and case can be locked when on the carrier
- Robust stainless steel latch buckles
- Fold back cover

REQUIRED FOR MOUNTING:

Side cases (from page 116)
Adapter kits (page 119)
TRAX lock set lock set (page 111)



Lockable case lid



Integrated lashing points for accessory bags





TRAVELER

SW-MOTECH

H
E
I
D
E
N
T
I
F
I
C
A
T
I
O
N

LAPHROAIG
ISLAY SINGLE MALT
SCOTCH WHISKY
10
Years Old

LAPHROAIG
ISLAY SINGLE MALT
SCOTCH WHISKY
10
Years Old

Distilled on the remote island
of Islay off the West coast
of Scotland, Laphroaig is the
most richly flavoured of all
Scotch whiskeys

Distilled on the remote island
of Islay off the West coast
of Scotland, Laphroaig is the
most richly flavoured of all
Scotch whiskeys

ACCESSORIES

TRAX SIDE CASE



TRAX BOTTLE/CANISTER KIT

For when the bike or the rider needs a refuel.

A TRAX bottle kit or TRAX canister kit can be attached using an accessory mount. The TRAX accessory mount (sold separately) is first bolted to the back of the case.

The TRAX bottle kit, available with one or two bottles, or the canister kit holding plate are then easily snapped in place. The stainless-steel bottles or the 2-liter canister are secured by two lashing straps and are quickly at hand when needed.

TRAX bottle set. Including bracket, 1 bottle	ALK.00.165.30700/S	29.41 €
TRAX bottle set. Including bracket, 2 bottles	ALK.00.165.30800/S	42.02 €



TRAX M/L EXPANSION BAG

Weatherproof, robust and flexible: The TRAX M/L accessory bag can be lashed to aluminum side cases from SW-MOTECH or other brands. It offers 15 liters of additional waterproof and dustproof storage space that can be reached quickly without opening the cases.

The large compartment with a circumferential, waterproof zipper and an additional overlapping lid allows quick access to the entire contents of the bag. The interior is padded and can be individually organized via dividers.

BC.ALK.00.732.10700/B	67.23 €
-----------------------	---------

TRAX M/L INNER BAG

The padded TRAX M/L inner bag protects even delicate luggage from vibrations and wear. A zipped lid compartment offers additional storage space for your wallet, smartphone or vehicle documents. When you arrive at your destination, it can be used as a comfortable travel bag thanks to its long handle bands.

BC.ALK.00.732.10000/B

42.02 €



TRAX ADV M/L LID INNER POCKET

Vehicle papers and important documents are safe and sound here. The padded inner lid pocket has mesh compartments and, thanks to the well-designed zipper system, gives quick access to the contents of the bag.

BC.ALK.00.732.10100/B

29.41 €



ACCESSORIES

TRAX SIDE CASE

TRAX			
TRAX lock set	6 locks/2 keys. Matching locks	ALK.00.165.16303	18.49 €
TRAX lock set	2 locks/2 keys. Matching locks.	ALK.00.165.16503	9.24 €
TRAX M/L inner bag	For TRAX side case. With volume expansion. Black.	BC.ALK.00.732.10000/B	42.02 €
TRAX M inner bag	For TRAX M side case. Waterproof. Black.	BCK.ALK.00.165.11000/B	25.21 €
TRAX L inner bag	For TRAX L side cases. Waterproof. Black.	BCK.ALK.00.165.10000/B	25.21 €
TRAX M/L expansion bag	For TRAX/BMW/other side cases. Black. 15 l.	BC.ALK.00.732.10700/B	67.23 €
TRAX accessory mount	For TRAX side case. Silver.	ALK.00.165.30900/S	25.21 €
TRAX bottle set 1	For TRAX accessory mount. Including 0.6l bottle, bracket.	ALK.00.165.30700/S	29.41 €
TRAX bottle set 2	For TRAX accessory mount. Including 2x 0.6l bottle, bracket.	ALK.00.165.30800/S	42.02 €
TRAX bottle	Stainless steel. Silver. 60 l.	ALK.00.165.31000/S	14.29 €
TRAX canister kit	For TRAX accessory mount. Including 2 l canister, bracket.	ALK.00.165.31100/B	37.82 €
TRAX canister	Plastic. Black. 2 l.	ALK.00.165.31200/B	12.61 €
TRAX ADV			
TRAX ADV M lid net	For TRAX ADV M side cases. Black	BC.ALK.00.732.10400/B	12.61 €
TRAX ADV L lid net	For TRAX ADV L side cases. Black.	BC.ALK.00.732.10500/B	12.61 €
TRAX ADV M/L inner lid bag	For TRAX ADV side case. 600D polyester. Black.	BC.ALK.00.732.10100/B	29.41 €
TRAX ION			
TRAX ION M/L carrying handle	For TRAX ION side cases. Black.	BCK.ALK.00.165.116	16.81 €
TRAX ION M/L expansion bag	For TRAX ION side cases. Black. 8 - 14 l.	BCK.ALK.00.165.117	58.82 €
TRAX ION reflective sticker set	For 2 TRAX ION side cases or 1 top case. Reflective. Black.	ALK.00.165.30100/B	16.81 €
TRAX ION reflective sticker set	For 2 TRAX ION side cases or 1 top case. Reflective. Silver	ALK.00.165.30100/S	16.81 €



ABS SIDE CASES

Hard shell, amazingly lightweight and a plush interior: ABS side cases have everything you need for a reliable luggage solution on sport motorcycles. AERO and URBAN differ in size and attachment method; both models are available as a set or as a complete system with mounting carriers.

AERO ABS SIDE CASES **120**

URBAN ABS SIDE CASES **122**

LUGGAGE **118**





AERO ABS SIDE CASES

Aerodynamic style, low weight, comfortable details: AERO ABS side cases impress with their streamlined shape and modern, particularly easy-care surface. These side cases made of heavy-duty ABS material offer 25 l of storage on each side with a net weight of just 1.8 kg. Together with the removable PRO or EVO side carriers, they are the ideal luggage solution for sport motorcycle travelers.

INCLUDED IN DELIVERY

Set: 2 AERO ABS side cases, 2 waterproof inner bags, 2 locks for motorcycle luggage

 25 l  52.0 x 39.0 x 22.0 cm  1,800 g

AERO ABS side case set **BC.HTA.00.675.12000/B** **252.10 €**

AERO ABS side case system including carriers & adapters **starting at 436.97 €**

Will it fit your motorcycle? Use the bike filter on sw-motech.com



REQUIRED FOR MOUNTING:

PRO/EVO side carrier (starting from page 126)
Adapter kit (page 132)



MATERIAL

- Made of heavy-duty, weather- and UV-resistant 2.5 mm (inner shell) and 2 mm (outer shell) ABS material
- Structured surface is easy to care for, scratch-resistant and lends the AERO ABS side cases a modern look

FUNCTION

- 25 l storage per case, weighing just 1.8 kg when empty
- Secure attachment via quick-release fastener to removable PRO or EVO side carriers from SW-MOTECH
- Plush interior: padded textile lining, elastic criss-crossing straps, mesh pocket, dedicated pocket for stowing case lock
- Theft protection: Case locks to carrier, lockable zipper, Case lock is included with purchase
- Reflective details for more safety in traffic
- Waterproof inner bag included in delivery
- Carrying handles allow for carrying two cases with one hand
- Lid limiter with snap closures secures the contents of the case



Integrated anti-theft protection for securing to side carrier



Robust carrying handle

URBAN ABS SIDE CASES

Hard shell, aerodynamic shape: Thanks to the light yet robust URBAN ABS cases, you can quickly turn a street bike into a touring motorcycle. URBAN ABS cases can be attached securely to the SLC side carrier via the quick-release fastener featuring integrated anti-theft protection in one swift move. These compact cases made of ABS plastic combine low weight with extra load-bearing capacity, underline the bike's dynamic design and only have a minimal impact on the driving characteristics.

INCLUDED IN DELIVERY

Set: 2 AERO ABS side cases, 2 waterproof inner bags, 2 locks for motorcycle luggage

 16,5 l  38.0 x 36.0 x 23.0 cm  1,400 g

URBAN ABS side case set **BC.HTA.00.677.10000/B** **218.49 €**

URBAN ABS side case system including carriers & adapters **starting at 176.47 €**

Will it fit your motorcycle? Use the bike filter on sw-motech.com



REQUIRED FOR MOUNTING:

SLC side carrier (starting on page 130)



MATERIAL

- Durable, robust and lightweight thanks to the 2.5 mm (inner shell) and 2 mm (outer shell) 2.5 mm thick ABS material
- The structured surface is easy to clean and scratch resistant

FUNCTION

- Lightweight side cases for sport motorcycles
- Secure mounting to the SLC side carrier via a quick-release fastener
- Criss-crossing straps and lid limiter with snap buckles secure case contents
- Removable, waterproof inner bag
- Reflective details for more safety in traffic
- Anti-theft protection thanks to protection on the SLC side carrier and lockable zippers
- Available individually, as a set or as a system including two SLC side carriers



Elastic criss-crossing straps with snap buckles



Both cases can be carried in one hand





SIDE CARRIERS

Flexibility, practicality and innovation were the development goals for our carrier systems. We brought the first removable carrier in the world on the market in 2001. Often imitated, still unsurpassed. The PRO side carrier, the latest generation of removable side carrier, is even more robust, even more adventurous.

Our SLC side carrier is not removable, but its design is particularly discreet – our solution for retro bikes, naked bikes, enduros and lightweight, sport machines.

PRO SIDE CARRIERS	128
EVO SIDE CARRIERS	129
SLC SIDE CARRIERS	130
SIDE CARRIER ACCESSORIES	132

PASSION FOR INNOVATION

Much has happened since the development of the world's first removable QUICK-LOCK carrier: more robust materials, evolving production technologies, new names. The dedication we show in developing our side carriers, however, remains unchanged. This product is a labor of love for us. Not just from a historical perspective. Maybe it's because we go back to the drawing board for every single motorcycle in our workshop: Where are the right mounting points? What is the best shape for the side carrier to fit perfectly? And what kind of carrier even makes sense for this motorcycle?

The bike-specific development of side carriers is both a blessing and a curse; it requires so much expertise and offers so many possibilities at the same time. With the right side carrier on your bike, luggage can be transported exactly the way you want.



Cases can be secured to the side carrier using a lock.



The side cases can be easily clipped into the four retaining cams on the carrier.



The EVO and PRO side carrier can be removed with just a few hand movements. Simply release the QUICK-LOCKS with a quarter turn, then only the sleek mounting components remain on the bike.



No matter the route, speed, distance, – it's the reliability, precision and, of course, the look that count.

We have accompanied the technological progress of motorcycles for 20 years and serve the growing demands of their riders. Whether on the street or far from marked roads, whether discreet or functional, we build side carriers for all specifications. At our plant in the Czech Republic, over 250 different steel side carriers have been welded. We currently offer exclusively produced carriers for more than 300 models of motorcycle.

The journey is not over yet. Many more motorcycles will be brought to market, and we will equip them with the right carriers. We take a close look at these bikes, then consider, construct and manufacture. That is how it was 20 years ago and how it still is to this day.



PRO SIDE CARRIERS

Even more robust, even more adventurous, yet still removable: the bike specific PRO side carrier made of 2.5 mm thick steel is extremely resilient and designed to fit closer to the bike.

In the course of the new production, the popular QUICK-LOCK quick-release fasteners were redesigned as well. The carrier can be removed completely in no time and all that remains on the bike are inconspicuous attachments.

INCLUDED IN DELIVERY

2 PRO side carrier, mounting hardware

PRO side carrier

starting at 193.28 €

Will it fit your motorcycle? Use the bike filter on sw-motech.com

MATERIAL

- Extremely durable: optimized shape and 2.5 mm thick steel
- Black powder coating protects against corrosion

FUNCTION

- Simple assembly at the original mounting points
- Fully removable with newly developed, even more robust quick-release fasteners
- For permanent assembly, the quick-release fasteners can be replaced by conventional screws.
- Combine with SW-MOTECH rack for even more storage
- Adapter kits are available for SW-MOTECH side cases, Givi/Kappa, Krauser and Shad as well as SysBag 15 and SysBag 30



ADAPTER KITS

The PRO side carrier can be combined with various cases made by other manufacturers. Prepared mounting points make it easy to attach the correct adapter kits.

> more on page 132



Perfect fit, designed to fit close to the bike



Numerous functional holes, various adapter kits available

EVO SIDE CARRIERS

With the EVO side carrier, your motorcycle can be converted into a touring bike with the flick of a wrist. The patented QUICK-LOCK system enables the quick mounting and removal of the carrier – with a quarter turn at the mounting points, the carrier can be removed completely. All that remains on the bike are the discreet mounting tabs. Thanks to separately available adapter kits, the EVO carrier provides secure support for cases from SW-MOTECH or other common manufacturers.

INCLUDED IN DELIVERY

2 EVO side carriers, mounting hardware

EVO side carrier

starting at 126.05 €

Will it fit your motorcycle? Use the bike filter on sw-motech.com

MATERIAL

- Robust construction from oval steel pipe
- Black powder coating protects against corrosion

FUNCTION

- Fully removable thanks to QUICK-LOCK quick-release fastener system
- Perfect fit, bike-specific development
- Anti-theft protection available separately
- Adapter kits for mounting TRAX ADV, TRAX ION, SysBag 30 and AERO ABS side cases, as well as other manufacturers' cases



TIP

With the practical tool kit for side carriers, you create extra storage for keeping tools and small spare parts. Mounting can be done in just a few steps, attaching or removing the side cases is not impeded by it.



Constructed from oval steel pipe close to the vehicle



Practical QUICK-LOCK quick-release fasteners

SLC SIDE CARRIERS

The precise, bike-specific development of the SLC side carriers allows for the simple and easy attachment to the original attachment points on the vehicle. Side bags can be attached and removed with a few hand grips via the quick-lock system, without the rider having to forego a reliable bag mount. The SLC carrier provides a secure hold for the Legend Gear LC1/LC2 side bags, the URBAN ABS side cases, the SysBag 10/15 with adapter plate, and the universal side bracket number plate.

INCLUDED IN DELIVERY

SLC side carrier (right or left), mounting hardware

SLC side carrier

starting at 33.61 €

Will it fit your motorcycle? Use the bike filter on [sw-motech.com](https://www.sw-motech.com)

MATERIAL & FUNCTION

- Made of powder-coated steel tubing
- Side carrier adapts perfectly to your motorcycle's look
- Bike-specific shape makes mounting easy on one or two sides
- Compatible with Legend Gear LC1/LC2 side bags, URBAN ABS side cases, SysBag 10/15 with adapter plate, universal side bracket, number plate
- Adapter kit is included in delivery.



Bike-specific development for best fit



Simple quick lock system

LUGGAGE SOLUTIONS FOR THE SLC SIDE CARRIER



URBAN ABS SIDE CASE

The aerodynamic URBAN ABS side cases create an attractive profile, whether on sporty street bikes, naked bikes or on enduros. The plastic cases combine light weight with high durability.

> more on page 122

SYSBAG 10/15 WITH ADAPTER PLATE

The versatile SysBag series with bags in three sizes offers the perfect luggage solution for every motorbike. The SysBag 10/15 with adapter plate can be securely fastened to SLC side carriers with a single click.

> more on page 68

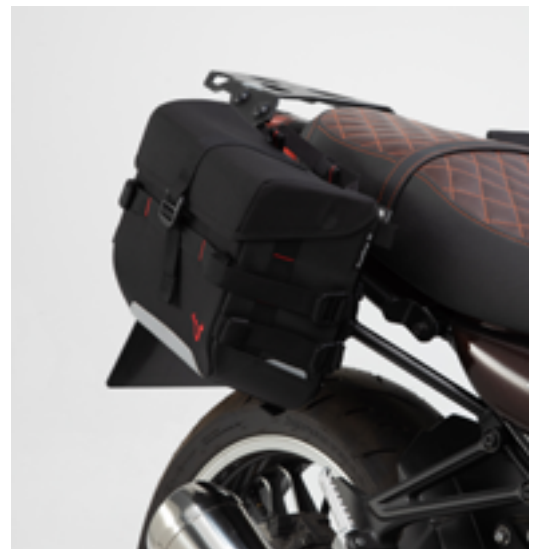

LEGEND GEAR SIDE BAGS LC1/LC2

Designed in a classic look exclusively for motorbikes, the Legend Gear soft luggage made of canvas and Napalon imitation leather captivates with its fashionable retro look. The side bags are also available in a Black Edition.

> more on page 62



ACCESSORIES

FOR SIDE CARRIERS



ADAPTER KIT FOR PRO SIDE CARRIER

The PRO side carrier is not only removable, but impressively flexible. Adapter kits are available for TRAX, AERO ABS and Nanuk side cases as well as SysBags 15/30 with adapter plate by SW-MOTECH, but also for cases by other manufacturers.

Prepared attachment points allow easy mounting of the adapter kit. Four retaining lugs and a latch buckle are mounted for TRAX aluminum cases.

Side carrier accessories

starting at 8.40 €

ADAPTER KITS FOR OTHER CARRIERS

TRAX aluminum cases can be used in combination with side carriers by SW-MOTECH and in many other configurations. Adapter kits were also developed for the original carriers of the BMW R1200 GS LC Adventure and for Givi carriers.

Once the adapter kit is mounted on the carrier, TRAX ADV, ION or EVO aluminum cases can then be attached. When changing motorcycles, all you need is a side carrier set from SW-MOTECH and an adapter kit. The rugged TRAX aluminum cases are true companions and you can just keep on using them.

Adapter kit for orig. carrier R1200/1250GS,F850GS	KFT.00.152.10900/S	92.44 €
Adapter kit for Givi carrier	KFT.00.152.10700/B	58.82 €

Will it fit your motorcycle? Use the bike filter on sw-motech.com



Adapter kits for PRO side carrier			
Adapter kit for PRO side carrier	For TRAX ADV/EVO/ION, NANUK side cases. For 2 cases.	KFT.00.152.35100	16.81 €
Adapter kit for PRO side carrier	For AERO ABS side cases. For 2 cases.	KFT.00.152.35200	16.81 €
Adapter kit for SysBag	For 1 adapter plate for SysBag 10/15/30. For PRO side carrier, EVO carrier. For STREET-RACK, ADVENTURE-RACK and ALU-RACK.	SYS.00.001.13000	8.40 €
Adapter kit for PRO side carrier	For Givi/Kappa with Monokey. For 2 cases.	KFT.00.152.35400	21.01 €
Adapter kit for PRO side carrier	For Krauser K-Wing, Hepco & Becker C-Bow side cases. For 2 cases. C-Bow not included.	KFT.00.152.35600	33.61 €
Adapter kit for PRO side carrier	For Shad I side cases and top case. Used for mounting 2 cases.	KFT.00.152.35700	33.61 €
Adapter kit for PRO side carrier	For Shad II side cases and top case. Used for mounting 2 cases.	KFT.00.152.35800	42.02 €
Adapter kit for PRO side carrier	For Rotopax. For mounting 1 canister. RotopaX bracket not included.	KFT.00.152.35900	25.21 €
Adapter kits for EVO side carrier			
Adapter kit for EVO carrier	For TRAX ADV/ EVO/ ION, NANUK. For 2 cases.	KFT.00.152.200	16.81 €
Adapter kit for EVO carrier	For AERO ABS side cases. For 2 cases.	KFT.00.152.22500/B	16.81 €
Adapter kit for EVO carrier	For Givi/Kappa Monokey. For 2 cases.	KFT.00.152.205	16.81 €
Adapter kit for EVO carrier	For Givi Trekker. For 2 cases. Not for the Outback/ V35, Dolomiti.	KFT.00.152.20500/B	16.81 €
Adapter kit for EVO carrier	For Krauser with K-Wing (Wing not included) For 2 cases.	KFT.00.152.220	33.61 €
Adapter kit for EVO carrier	For Shad. Mounting for 2 cases. Not for the 3P System.	KFT.00.152.215	33.61 €
Adapter kit for EVO carrier	For Hepco & Becker. For 2 plastic cases.	KFT.00.152.210	33.61 €
Adapter kits for side carriers by other manufacturers			
Adapter kit for orig. carrier R1200/1250GS,F850GS	For TRAX ADV/ION/EVO. For 2 cases.	KFT.00.152.10900/S	92.44 €
Adapter kit for orig. R1200GS Adv. carrier	For TRAX ADV/EVO. For 2 cases.	KFT.00.152.10801/S	67.23 €
Adapter kit for Givi carrier	For TRAX ADV/EVO/ION side cases. For 2 cases.	KFT.00.152.10700/B	58.82 €
Accessories for SLC side carriers			
Universal side bracket left	For SLC side carrier left. Incl. Net.	HTA.00.401.15100	58.82 €
Universal side bracket right	For SLC side carrier right. Incl. Net.	HTA.00.401.15200	58.82 €
Number plate	For SLC side carrier left.	HTA.00.401.15300	37.82 €
Number plate	For SLC side carrier right.	HTA.00.401.15400	37.82 €
Accessories for PRO/EVO side carriers			
Anti-theft protection for PRO side carrier	QUICK-LOCK. 2 locks and 2 keys. Interchangeable.	QLS.00.095.10000/B	37.82 €
Anti-theft protection for EVO carrier	QUICK-LOCK. 2 locks and 2 keys. Interchangeable.	QLS.00.046.10100/B	37.82 €
Tool box for side carrier	Mounting kit included. Black. Mounted onto the inside left of the rack.	KFT.00.152.30100/B	33.61 €
TRAX ION reflective sticker set	For 2 TRAX ION side cases or 1 top case. Reflective. Silver	ALK.00.165.30100/S	16.81 €

TOP CASES

Plenty of room, storage for a helmet and anti-theft protection: Features of all our aluminum TRAX ADV, TRAX ION and URBAN ABS top cases. These top cases can be easily mounted to our Adventure Rack or Street Rack and secured to the rack with a single latch.

Our top cases are a convenient solution for every tour in combination with their matching side cases or on their own.

TRAX ADV	136
TRAX ION	140
TOP CASE ACCESSORIES	142
URBAN ABS TOP CASES	144
SYSBAGS ON RACKS	146



TOP OF THE LINE

Some love it, others hate it – the topcase. We build our TRAX ADV top case for everyone who loves it.

It's stable, dust and waterproof, is easy to handle and offers enough storage for long tours. We developed the TRAX ADV top case to go with the TRAX ADV side cases and we build it to the same high standards of quality.

IT STAYS SEALED

The 1.5-mm aluminum sheet is shaped in our plant in the Czech Republic before it is made into a top case in Rauschenberg. Every top case is welded using robot assistance and tested for 100% tightness. It's not a genuine TRAX ADV top case until that's done. Thanks to a special membrane, opening the top case is child's play, even after significant changes in pressure and temperature.



A lock in the latch buckle secures the top case against theft.



The latch buckle lets you quickly and securely attach your top case.



Simple attaching to the retaining
cams of the ADVENTURE-RACK.



THAT IS WELL-DESIGNED

The TRAX ADV top case offers room for 38 liters worth of luggage and you can even comfortably stow your helmet here. We have built in stable aluminum handles into the lid for easier carrying and straightforward mounting. The lashing points directly next to the handles allow for additional luggage to be mounted, and we offer the right matching lock set so you can combine this with the TRAX ADV side cases.

THAT FITS ON THE BIKE

You can choose from a silver anodized design or the black powder-coated design. The solid ADVENTURE-RACK made from 4-mm thick aluminum alloy is a great choice for mounting it. When buying, make sure to select the ADVENTURE-RACK that fits your bike model. Or just get the top case in a set with the matching rack.





TRAX ADV TOP CASE

The TRAX ADV top case is the premium luggage solution for the tail and is roadworthy but also suitable for off-road use. The robust aluminum cases boast the same quality features that distinguish the series' side cases (page 108) and are ideal counterparts. The lockable top case offers 38 L of storage and easily holds a motorcycle helmet.

INCLUDED IN DELIVERY

TRAX ADV top case, lid limiter, storage bag

 38 l  41.0 x 34.0 x 33.0 cm  4,800 g

TRAX ADV top case, black	ALK.00.733.15000/B	294.12 €
TRAX ADV top case, silver	ALK.00.733.15000/S	294.12 €
TRAX ADV top case system		starting at 403.36 €

Will it fit your motorcycle? Use the bike filter on sw-motech.com



REQUIRED FOR MOUNTING:

Racks and adapters (from page 148)
TRAX lock set (page 143)

TRAX ADV side cases (page 108)



THE COMPLETE SOLUTION

The TRAX ADV top case system encompasses all products needed for mounting a top case: TRAX ADV top case, bike-specific rack, adapters and TRAX lock set.

MATERIAL

- Premium top case made from 1.5 mm-thick aluminum
- Protection against oxidation and abrasion with powder coating (black model) or anodizing (silver model)
- Additional protection on corners made of glassfiber-reinforced polyamide

FUNCTION

- Hinged lid with limiter stay, stainless steel latch, sturdy carrying handles and integrated mounting points
- 100% water- and dustproof due to robotic welding and punch rivet technology
- Theft protection: Case lid and case can be locked when on the carrier
- High strength thanks to the visually appealing and functional embossed sheet metal



Easy to attach to ADVENTURE-RACK



Separately available cargo net in the case lid







TRAX ION TOP CASE

Heavy-duty design with a body of a strong yet lightweight 1.5 mm thick aluminum body, reinforced with durable plastic elements: The TRAX ION top case weighs only 4.6 kg with 38 l of storage and can hold a helmet. SW-MOTECH racks provide a secure mount for the TRAX ION top cases. The robust aluminum cases boast the same quality features that distinguish the series' side cases (page 112) and are ideal counterparts.



INCLUDED IN DELIVERY

TRAX ION top case, storage bag

 38 l  41.0 x 34.0 x 33.0 cm  4,600 g

TRAX ION top case, black **ALK.00.165.15001/B** **260.50 €**

Will it fit your motorcycle? Use the bike filter on sw-motech.com

REQUIRED FOR MOUNTING:

Racks and adapters (from page 148)
TRAX lock set (page 143)

TRAX ION side case (page 112)



MATERIAL & FUNCTION

- Robust & light: Aluminum top case with a wall thickness of 1.5 mm
- Black powder coating that protects luggage from abrasion
- Additional protection from plastic edges
- Waterproof through robot-supported welding, punch rivet technology and interchangeable cover gaskets
- Theft protection: Case lid and case can be locked when on the carrier

ACCESSORIES

FOR TOP CASES



TRAX ADV TOP CASE LID NET

Everything close at hand: Papers or rain suit at the ready when they are stored in the lid net of the TRAX ADV top case. Our aluminium cases offer plenty of storage – so keeping everything organized is more important than ever. The lid net, available for the top case and side cases of the TRAX ADV series, is a proven solution. The highly flexible netting is suspended from the lid interior. This easily accessible storage is now available for gear.

BC.ALK.00.732.10600/B

12.61 €



TRAX TOP CASE INNER BAG

This waterproof inner bag, made of black tarpaulin is specially cut for the TRAX top case 38 L and offers additional protection from water.

BCK.ALK.00.165.15000/B

25.21 €



TRAX TOP CASE INNER BAG – PADDED

Who wants to haul luggage after a challenging tour?

Thanks to the carrying handle, the padded TRAX top case inner bag can be easily removed from the case and the touring luggage becomes a travel bag. The large opening allows quick access to the bag contents and a non-slip, sturdy underside guarantees secure positioning on any surface.

BC.ALK.00.732.10300/B

42.02 €

TRAX			
TRAX lock set	6 locks/2 keys. Matching locks	ALK.00.165.16303	18.49 €
TRAX lock set	2 locks/2 keys. Matching locks.	ALK.00.165.16503	9.24 €
TRAX top case inner bag	For TRAX top case. Water resistant. Black.	BC.ALK.00.732.10300/B	42.02 €
TRAX top case inner bag	For TRAX top case. Waterproof. Black.	BCK.ALK.00.165.15000/B	25.21 €
TRAX ADV			
TRAX ADV top case passenger backrest	For TRAX ADV top case. Black.	ALK.00.732.10200/B	50.42 €
TRAX ADV top case lid net	For TRAX ADV top case. Black.	BC.ALK.00.732.10600/B	12.61 €
TRAX ION			
TRAX ION top case passenger backrest	For TRAX ION top case. Black.	ALK.00.165.30000/B	37.82 €
TRAX ION reflective sticker set	For 2 TRAX ION side cases or 1 top case. Reflective. Black.	ALK.00.165.30100/B	16.81 €
TRAX ION reflective sticker set	For 2 TRAX ION side cases or 1 top case. Reflective. Silver	ALK.00.165.30100/S	16.81 €



URBAN ABS TOP CASES

Sporty, lightweight and robust: The aerodynamic URBAN ABS top case with 16 to 29 l volume is just the right size for short, everyday trips or leisure rides, and even holds a helmet.

The particularly plush model of the URBAN ABS top case is easily attached to the STREET-RACK using the DHV system, a newly developed quick-release fastener. An adapter kit is required for installing on the ADVENTURE-RACK. Alternatively, the top case is also available as a tie-down model.

INCLUDED IN DELIVERY

URBAN ABS top case, DHV system for STREET-RACK / ADVENTURE-RACK or bottom insert for tie-down model, waterproof inner bag, lock for motorcycle luggage, 4 loop straps

 16 – 29 l  40.5 x 21.5 x 36.0 cm  2,300 g

URBAN ABS top case for STREET-RACK / ADVENTURE-RACK	BC.HTA.00.677.21000/B	142.86 €
---	-----------------------	----------

URBAN ABS top case system (incl. STREET-RACK / ADVENTURE-RACK)		starting at 210.08 €
--	--	----------------------

URBAN ABS Topcase lashing version	BC.HTA.00.677.22000/B	126.05 €
-----------------------------------	-----------------------	----------

Will it fit your motorcycle? Use the bike filter on sw-motech.com

MATERIAL & FUNCTION

- Durable, robust and lightweight due to the 2.5mm (bottom) and 2mm (top) thick ABS plastic
- Lightweight top case for sport motorcycles, naked bikes and enduros
- Anti-theft protection by securing to the rack (only with DHV system), lockable zipper and lock for motorcycle luggage
- With the volume fully expanded, the URBAN ABS top case holds a helmet
- Reflective details



TIP:

Simple attachment using quick-release fastener on the bike-specific STREET-RACK (from page 152)



Enough space for a helmet



Robust carrying handle



FOR STREET-RACK AND ADVENTURE-RACK

Attaches securely to the STREET-RACK or ADVENTURE-RACK with just one hand movement thanks to a user friendly quick-release fastener.



ANTI-THEFT PROTECTION

The top case is easily and firmly attached to the carrier with a single push and can be additionally secured with the integrated anti-theft protection.



URBAN ABS TOP CASE AS TIE-DOWN VARIATION

A reliable 4-point mount with loop straps gives this variation of the URBAN ABS top cases secure hold on almost any motorcycle tail.

NON-SLIP BASE INSERT

The curved base insert made of foam rubber can be perfectly positioned on the seat and simultaneously serves a non-slip and vibration-damping function.

SYSBAGS ON RACKS



One of our most versatile luggage systems, the SysBag can be attached by means of an adapter plate not only to side carriers, but just as quickly to the ADVENTURE-RACK, STREET-RACK, STEEL-RACK and ALU-RACK by SW-MOTECH. The quick-release fastener is latched with a single click, and easily released via drawstring.

The adapter kit is screwed directly onto the ADVENTURE-RACK or STEEL-RACK, mounting on the STREET-RACK occurs on the adapter plate. An adapter kit is required for mounting on PRO/ EVO side carriers or racks. This is included in the delivery of the SysBag 15/30 with adapter plates.



TIP:

SysBags (from page 68)
Racks and adapters (from page 148)



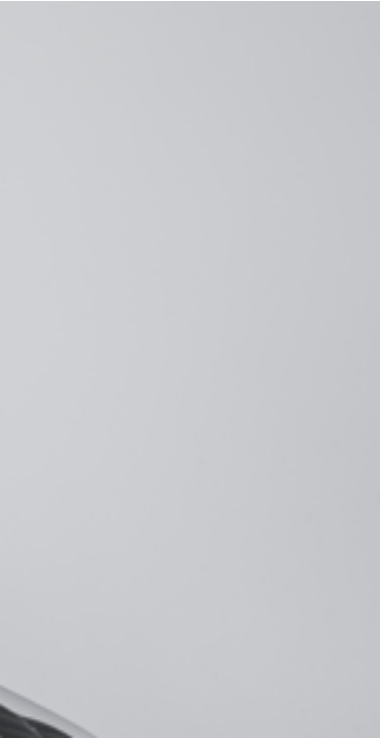



RACKS

Our motorcycle luggage racks stand out for their sturdiness, versatility and perfect fit.

15 years of experience in the production of motorcycle rear carriers flow into the development of the extremely durable ADVENTURE-RACK and the sporty STREET-RACK. Classics like the popular ALU-RACK and the SEAT-RACK, which replaces the passenger seat, are still available for select bike models.

ADVENTURE-RACK	150
STREET-RACK	152
ALU-RACK	154
OTHER LUGGAGE SOLUTIONS	156

ADVENTURE-RACK

Ready for big adventure: Our ADVENTURE-RACK proves itself with its extreme durability and function-oriented shape. More than 15 years of experience producing racks, combined with feedback from customers and test riders, went into the development of this aluminum rack. Material thickness, weight and geometry have been optimized for demanding tours and off-road use.

Developed specifically for enduros, large road and sports touring bikes, the ADVENTURE RACK offers a large contact surface, lots of big lashing eyelets and functional holes for attaching adapter kits for top cases from SW-MOTECH, Givi, Krauser and Shad or SysBags with adapter plate.



INCLUDED IN DELIVERY

ADVENTURE-RACK, mounting hardware

ADVENTURE-RACK

starting at 92.44 €

Will it fit your motorcycle? Use the bike filter on [sw-motech.com](https://www.sw-motech.com)

MATERIAL

- Made of light but sturdy 4mm-thick aluminum alloy
- Effective corrosion protection from black powder coating

FUNCTION

- Its extreme durability during vibrations, impacts and heavy loads was tested in the lab and off-road under harshest conditions
- Easy installation on original attachment points with bike-specific attachment elements
- Multiple functional bores, compatible with adapter kits for top cases from SW-MOTECH, Givi/Kappa, Krauser and Shad or SysBags 15/30 with adapter plate
- Multiple large tie-down points



Adapter kits for the TRAX ADV top case and many other top cases

ADAPTER KITS

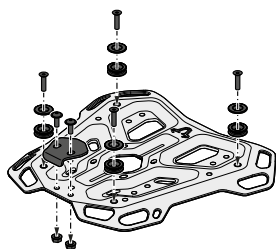

FOR TOP CASES & SYSBAGS

The adapter kits are screwed directly onto the rack and thus ensure extremely stable support.

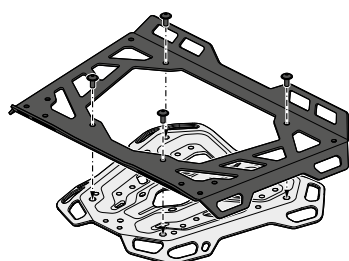

EXTENSION FOR THE LASHING OF LUGGAGE

The extension further widens the already generous contact surface by around 30 percent to 45 x 30 cm.

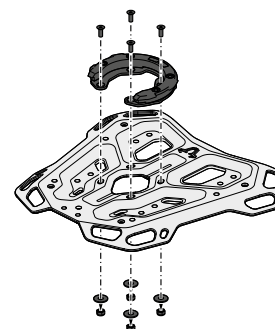

FOR PRO TANK BAGS

This PRO tank ring also allows you to fasten PRO tank bags with a flat bottom onto the ADVENTURE-RACK.

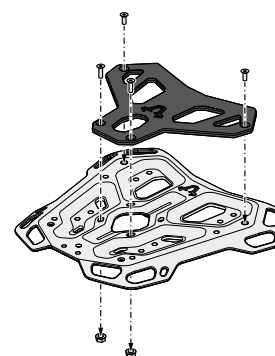

FOR STREET-RACK ADAPTER PLATE

Simply screw it on and the multifunctional STREET-RACK adapter plate (page 152) can be locked in place.

ADAPTER FOR PRODUCTS BY SW-MOTECH			
For TRAX ADV, ION, EVO. Black/silver.	from page 106	GPT.00.152.35100/B	15.13 €
For 1 adapter plate for SysBag 10/15/30.	from page 68	SYS.00.001.13000	8.40 €
For PRO tank bags. Black. Micro, Daypack, Sport, Yukon WP	from page 36	GPT.00.152.36100/B	21.01 €
45x30 cm. Aluminium. Black. Also for adapter plate for STREET-RACK/ALU-RACK.		GPT.00.152.35500/B	42.02 €
Mounting the STREET-RACK adapter plate onto the ADVENTURE-RACK. Black.		GPT.00.152.35000/B	25.21 €
ADAPTER FOR PRODUCTS FROM OTHER MANUFACTURERS			
For Givi, Kappa with Monolock. Black.		GPT.00.152.35300/B	21.01 €
For Givi/Kappa Monokey. Black. Not compatible with MonoKey side system.		GPT.00.152.35400/B	21.01 €
For Krauser K-Wing, Hepco & Becker C-Bow. K-Wing/C-Bow not included. Black.		GPT.00.152.35600/B	21.01 €
For Shad. Black.		GPT.00.152.35700/B	21.01 €
For Shad 2. Black.		GPT.00.152.35800/B	25.21 €
For RotopaX. RotopaX mount not included. Black.		GPT.00.152.35900/B	21.01 €

STREET-RACK

The compact STREET-RACK was developed specially for sporty motorcycles, naked bikes and smaller street bikes. The URBAN ABS top case or an adapter plate can be fixed to the rack in one step without any tools. The adapter plate offers a sturdy base for top cases from SW-MOTECH, Givi, Krauser and Shad or SysBags 15/30 with adapter plate.

The STREET-RACK is also suitable for lashing luggage when combined with the expansion with extra large contact surface, available separately. With our STREET-RACK, your bike is ready for the next long tour in a few simple steps.

INCLUDED IN DELIVERY

STREET-RACK, mounting hardware



STREET-RACK

starting at 67.23 €

Will it fit your motorcycle? Use the bike filter on [sw-motech.com](https://www.sw-motech.com)

MATERIAL

- Made of 5-mm thick aluminum alloy
- Black powder coating protects against corrosion

FUNCTION

- Perfect fit due to bike-specific attachments and high-precision CNC production processes
- Compact shape complements the lines of sporty motorcycles and small street bikes
- Simple assembly at the original mounting points



The STREET-RACK adapter plate offers mounting points for various adapter kits

ADAPTER KITS

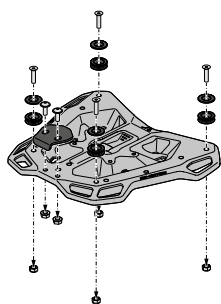

FOR TOP CASES & SYSBAGS

The multifunctional adapter plate features functional holes for mounting various adapter kits.

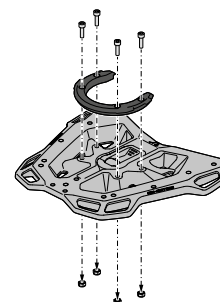

FOR PRO TANK BAGS

The PRO tank ring for PRO tank bags can also be screwed onto the adapter plate.

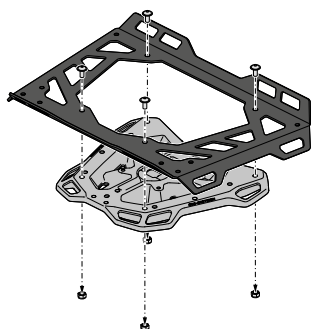

EXTENSION FOR THE LASHING OF LUGGAGE

Extension with an extra large contact surface (45 x 30cm) for the lashing of tail bags. Tip: Rackpack tail bag (page 82)

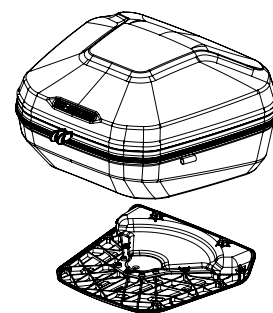

URBAN ABS TOP CASE

The URBAN ABS top case (page 144) can be pushed directly onto the carrier and locked in place with a swift hand movement.

ADAPTER FOR PRODUCTS BY SW-MOTECH

For TRAX top case ADV, ION, EVO. Black.	from page 106	GPT.00.152.54100/B	25.21 €
For 1 adapter plate for SysBag 10/15/30. For PRO side carrier, EVO carrier. For STREET-RACK, ADVENTURE-RACK and ALU-RACK.	from page 68	SYS.00.001.13000	8.40 €
For PRO tank bags Micro, Daypack, Sport, Yukon WP. Including adapter plate.	from page 36	GPT.00.152.55200/B	42.02 €
For PRO tank bags Micro, Daypack, Sport, Yukon WP. Without adapter plate	from page 36	GPT.00.152.55300/B	25.21 €
45x30 cm. Aluminum. Black. With adapter plate.		GPT.00.152.54500/B	50.42 €
Baseplate. Without adapter kit for top case.		GPT.00.152.50000/B	21.01 €

ADAPTER FOR PRODUCTS FROM OTHER MANUFACTURERS

For Givi/Kappa with Monolock. Black.		GPT.00.152.54300/B	25.21 €
For Givi/Kappa with Monokey. Black.		GPT.00.152.54400/B	25.21 €
For Krauser K-Wing, Hepco&Becker C-Bow. Black.		GPT.00.152.54600/B	33.61 €
For Shad. Black.		GPT.00.152.54700/B	33.61 €
For Shad 2. Black.		GPT.00.152.54800/B	33.61 €
For RotopaX. RotopaX mount not included. Black.		GPT.00.152.35900/B	21.01 €

ALU-RACK

The elegant and versatile ALU-RACK is a sleek, well-shaped rack. The aluminum all-rounder combined with an appropriate adapter plate provides secure grip for top cases from SW-MOTECH or other manufacturers, as well as SysBag 30. A simple mounting of the adapter plate on the ALU-RACK happens with just three quick-release fasteners. To secure the top case to the adapter plate in turn you just need one hand grip - thanks to the QUICK-LOCK quick-release fastener system. The ALU-RACK is also suitable for rigging tail bags, particularly in combination with the expansion that is available separately.

INCLUDED IN DELIVERY

ALU-RACK, mounting hardware

ALU-RACK

starting at 75.63 €

Will it fit your motorcycle? Use the bike filter on [sw-motech.com](https://www.sw-motech.com)



MATERIAL

- Made from aluminum alloy
- Effective corrosion protection from black powder coating

FUNCTION

- Bike-specific development and high-precision CNC production process ensure the best fit
- Can also be used in combination with PRO / EVO side carriers and TRAX side cases



The adapter plate offers mounting points for various adapter kits

ADAPTER KITS

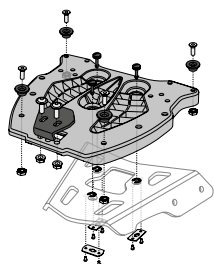

FOR TOP CASES

Adapter kits for TRAX top cases from SW-MOTECH and other manufacturers are also available for this adapter plate.

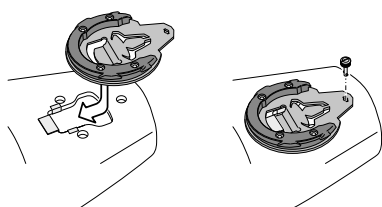

FOR PRO TANK BAGS

Simply slide the PRO tank ring onto it, secure it with the quick-release fastener and the PRO tank bags will stay in place.

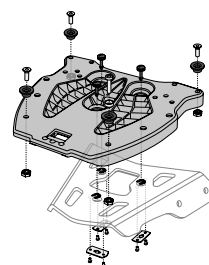

FOR SYSBAG 30

With the adapter plate and corresponding adapter kit, the SysBag 30 can be easily clicked on as well.

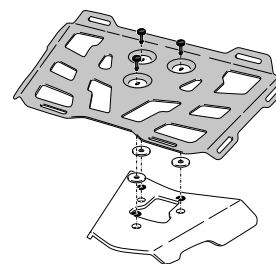

EXTENSION FOR THE LASHING OF LUGGAGE

Ideal for soft luggage: the extension provides a large contact surface (43 x 27 cm) and lots of lashing eyelets.

ADAPTER FOR PRODUCTS BY SW-MOTECH

For TRAX top case. Black.	from page 106	GPT.00.152.400	25.21 €
For 1 adapter plate for SysBag 10/15/30. For PRO side carrier, EVO carrier. For STREET-RACK, ADVENTURE-RACK and ALU-RACK.	from page 68	SYS.00.001.13000	8.40 €
For PRO tank bags Micor, Daypack, Sport, Yukon WP. QUICK-LOCK. Black.	from page 36	TRT.00.787.20400/B	42.02 €
43x27 cm. QUICK-LOCK. Aluminium. Black.		GPT.00.152.43001/B	42.02 €
Baseplate. Without mounting for top case. Black.		GPT.00.152.450	25.21 €

ADAPTER FOR PRODUCTS FROM OTHER MANUFACTURERS



For Givi, Kappa, Monokey. Black.		GPT.00.152.405	25.21 €
For Givi/Kappa Monolock. Black.		GPT.00.152.406	25.21 €
For Hepco & Becker. Black. Not for Hepco & Becker universal top cases, ORBIT, and TC50.		GPT.00.152.410	33.61 €
For Shad. Black.		GPT.00.152.415	33.61 €
For Krauser. Black.		GPT.00.152.420	25.21 €
For Rotopax. Rotopax mount not included. Black.		GPT.00.152.35900/B	21.01 €



OTHER LUGGAGE SOLUTIONS

DRYBAG 300 BACKPACK

The Drybag 300 is a real all-weather backpack: This durable bag protects up to 30 l luggage from water and dirt and has an ergonomic carrying system. The Drybag is available in grey and signal yellow.

 30 l	 24,0 x 26,0 x 48,0 cm	 1,200 g
Drybag 300, grey	BC.WPB.00.011.10000	58.82 €
Drybag 300, yellow	BC.WPB.00.011.10000/Y	58.82 €

MATERIAL & FUNCTION



- Made of waterproof polyester with coating
- Waterproof roll closure
- Padded shoulder and waist belt for wearing comfort and the best fit
- Outer pocket with zipper
- Reflective details



DRYBAG 20 HIP PACK

The hip pack Drybag 20 only weighs 350 g and offers a safe place for valuables and smartphone. Made of rugged and easy-to-clean tarpaulin, this waterproof waist bag offers a compact size and comfortable fit.



 2 l	 350 g	
Drybag 20 hip pack	BC.WPB.00.005.10002	25.21 €

MATERIAL & FUNCTION

- Made of waterproof polyester with coating
- Padded hip belt
- Front compartment with zipper
- Reflective details

TRITON BACKPACK

The waterproof Triton backpack with 20 l of volume is perfect for all weather conditions and offers a clever partitioning system and volume adjustment.

The ergonomic carrier system with strap management makes the backpack a convenient companion for day tours.



20 l 35,0 x 66,0 x 14,0 cm 1,200 g

Triton backpack

BC.WPB.00.004.10001

63.03 €

MATERIAL & FUNCTION

- Made of waterproof polyester with coating
- Adjustable carrying system with padded waist strap
- Roll closure
- Outer pocket with zipper
- Adjustable volume compression
- Organizer compartments, padded laptop holder
- Reflective details

BARACUDA BACKPACK

The waterproof, multi-functional Baracuda backpack with its easy-to-clean tarpaulin outer shell reliably protects up to 25 liters of luggage from water and dirt. Aside from numerous storage compartments, the padded interior also has a 17" laptop compartment. At the same time, the completely adjustable, padded belt system of the motorcycle backpack increases comfort and reflective details make you more visible in traffic.



25 l 38,0 x 73,0 x 21,0 cm 1,600 g

Baracuda backpack

BC.WPB.00.003.10001

75.63 €



MATERIAL & FUNCTION

- Made of waterproof polyester with coating
- Adjustable carrying system with padded waist strap
- Roll closure
- Outer pocket with zipper
- Adjustable volume compression
- Organizer pockets, padded laptop compartment
- Reflective details

FLEXPACK BACKPACK

Folded up, the Flexpack is as big as a fist and fits in a tank bag or under the seat. If required, this little helper can be instantly transformed into a 30-liter backpack that can also hold a helmet



 30 l  22,0 x 50,0 x 22,0 cm  200 g

Flexpack backpack

BC.WPB.00.019.10000

16.81 €

MATERIAL & FUNCTION



- Made of 75D ripstop polyester with water resistant coating
- Lightweight and extremely compact when folded
- Holds a motorcycle helmet

LEG BAG-SET WITH LA8

Going for a short ride? What do you do with your wallet, keys and phone if you don't have any luggage? With the retro-style Legend Gear leg bag, you can wear the most important things directly on your body.

INCLUDED IN DELIVERY

Set: Legend Gear leg bag LA8, Legend Gear holster LA7, rain hood, instructions

 1.25 l  13,0 x 19,5 x 5,0 cm  170 g

Legend Gear holster LA7	BC.TRS.00.409.10000	16.81 €
Legend Gear leg bag LA8	BC.TRS.00.410.10000	25.21 €
Legend Gear leg bag-set with LA8	BC.TRS.00.409.50000	42.02 €



MATERIAL & FUNCTION

- Secure hold of holster with leg strap, optional hip strap and back with anti-slip coating
- Straps of the holster can be individually adjusted to leg length, thigh and hip circumference
- Fast removal using practical snap buckles

SAFETY

See and be seen. Illuminate the road ahead with EVO auxiliary lights and keep a better eye on what's behind you with mirror extensions. Especially on tours with heavy luggage, side stand foot extensions and centerstands provide secure options for parking on soft and uneven terrain.

CENTERSTANDS	162
EXTENSIONS FOR SIDE STAND FOOT	164
MIRROR EXTENSIONS	166
EVO LIGHTS	168
ACCESSORIES	170





CENTERSTANDS

When it comes to new motorcycle models, we're usually the first accessory supplier to put high-quality centerstands models on the market. The lightweight steel-tube centerstands are designed to fit as closely as possible to the motorcycle to preserve ground clearance, all without sacrificing stability or convenience.

In most cases, you no longer need to buy a swingarm stand or spools. During long downtimes in the winter months, the centerstand helps take the load off your tires.

INCLUDED IN DELIVERY

Centerstand, mounting hardware



Centerstands

starting at 117.65 €

Will it fit your motorcycle? Use the bike filter on [sw-motech.com](https://www.sw-motech.com)

MATERIAL

- Made of robust steel
- Blasting the surface prior to powder coating improves corrosion resistance

FUNCTION

- Ensures a secure stand on trips with lots of luggage and during maintenance
- Bike-specific design for easy mounting and high cornering clearance
- Easy to lift up the motorcycle
- Outrigger foot pedal for optimal leverage



Constructed to provide the greatest possible cornering clearance



A secure stand during maintenance

EXTENSIONS FOR SIDE STAND FOOT

This durable foot extension has a large contact surface for enhanced stability, even on uneven ground and soft soil.

Accuracy of fit and easy handling for everyday driving were both equally important during product development. The profiled topside of the foot extension makes it easy to fold out the stand - even with heavy boots.

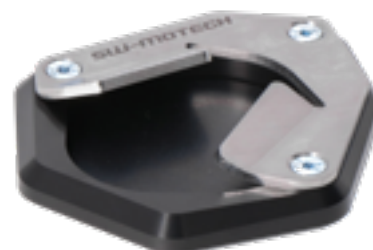

INCLUDED IN DELIVERY

Extension for side stand foot, mounting material

Extensions for side stand foot

starting at 21.01 €

Will it fit your motorcycle? Use the bike filter on [sw-motech.com](https://www.sw-motech.com)

MATERIAL

- High-quality workmanship: CNC milled
- Anodized aluminum alloy

FUNCTION

- Doubles the foot's surface area (bike specific)
- Provides secure positioning on soft or uneven ground
- Bike-specific sandwich design provides strength and precision fit
- Mounts on original side stand



For a secure stand and greater contact surface on uneven ground.





MIRROR EXTENSIONS

To ensure that your own shoulders aren't the only thing you see in the rear-view mirror, the extension elements provide a significantly improved field of vision by relocating the mirrors to the outside. Once adjusted and screwed on, the sturdy, well-designed extensions provide secure hold for the mirrors, even when riding off-road or at high speeds. The various mounting options for these mirror extensions match the appearance of any motorcycle - whether it's an enduro, naked bike or a fully-faired street bike.

INCLUDED IN DELIVERY

2 mirror extensions, mounting hardware

Mirror extensions

starting at 33.61 €

Will it fit your motorcycle? Use the bike filter on sw-motech.com

VERSIONS

EXCLUSIVE FOR BMW

Mounts into existing mirror threads. Black powder coated steel. Up to 6.6cm lateral relocation. Unrestricted access to grip switches.



FOR MIRRORS MOUNTED ON THE HANDLEBAR

Mounts into existing mirror threads. Black anodized aluminium. Up to 4 cm higher, up to 4 cm lateral shift.



PROFILE EXTENSION

For fairing mirrors. Black milled polyamide. Lateral relocation of up to 4 cm.



HINGE EXTENSION

For fairing mirrors. Black anodized aluminium. Up to 4cm lateral relocation.



EVO LIGHTS

Increased safety on the road: The extra-wide beam of the EVO fog lights provide increased „see and be seen“ capabilities, especially in fog and bad weather. The powerful, more focused light of the EVO high beams provide excellent long-range illumination. This provides optimal lighting for the rider's view and ensures safety during on- or off-road riding.

INCLUDED IN DELIVERY

2 EVO lights, cable harness with fuse, handlebar switch



 12 W/1.050 LM ECE R19 F3

EVO fog lights NSW.00.490.10001 252.10 €

EVO fog lights kits including light mounts starting at 281.51 €

Will it fit your motorcycle? Use the bike filter on sw-motech.com

 12 W/800 LM ECE R113 Rev.2

EVO high beam NSW.00.490.10101 252.10 €

Will it fit your motorcycle? Use the bike filter on sw-motech.com

REQUIRED FOR MOUNTING

Crash bar clamps or bike-specific light brackets.

> more on page 168



MATERIAL & FUNCTION EVO LIGHTS

- High-quality aluminum housing, black powder coated
- Water and dustproof (safety class: IP69)
- Voltage: 12V
- LED technology reduces electrical system load and reduces heat output, resulting in greater longevity
- Compact size with a diameter of 7.1 cm
- Lights have an ECE test mark

FUNCTION EVO FOG LIGHTS

- Power: 12 W / luminous flux: 1,050 LM
- ECE test mark: ECE R19 F3
- Splash-proof and bright green handlebar switch for convenient operation
- Particularly wide light distribution

FUNCTION EVO HIGH BEAMS

- Power: 12W / luminous flux: 800 LM
- ECE test mark: ECE R113 Rev.2
- Splash-protected, blue glowing handlebar switch for comfortable operation
- Highly concentrated beam with long-distance range

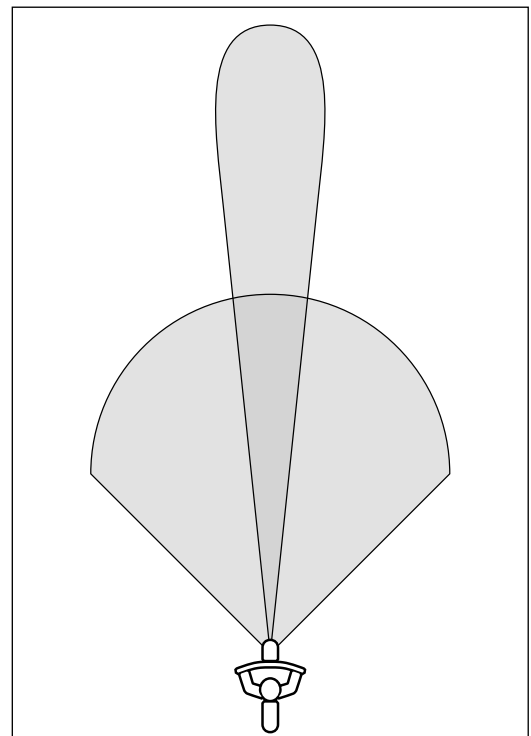

Comparison of light distribution of EVO fog lights and high beams.



ACCESSORIES

EVO LIGHTS



LIGHT MOUNTS

These bike-specific mounts provide optimal positioning of the EVO lights, because they are developed exclusively for each motorcycle model.

The sturdy brackets are made of powder-coated steel and are screwed onto existing attachment points. They guarantee a secure hold for the EVO lights, even when riding off-road.

The lights can be mounted upright, hanging down or to the side, depending on the motorcycle model.

EVO fog light and high-beam light kits are available for many motorcycle models; these include the lights, cable harness and switches as well as the corresponding bike-specific mounts.

Light mounts	starting at 16.81 €
--------------	---------------------

EVO FOG LIGHT SWITCH FOR COCKPIT

The splash-proof and illuminated on/off switch can be mounted on barrel handlebars with a diameter from 22 mm to 1 inch (25.4 mm). The connection is made via an insulated cable with three plug connections, cable length 30 cm, for 12 V motor vehicle operating voltage.

EMA.00.107.12900	16.81 €
------------------	---------



EVO LIGHT GUARDS

The brushed stainless steel guard protects the housing of the EVO lights while giving your bike an adventurous look. It is attached directly to the lights with only two screws. Looks elegant thanks to the brushed stainless steel and laser-etched SW-MOTECH logo. Two guards as well as the mounting material are included in delivery.

NSW.00.490.10201

33.61 €



CRASH BAR CLAMP

With these clamps, EVO lights can be mounted to crash bars or other bike parts of the appropriate diameter. Includes rubber inserts for adapting to 22/25.4/27/27 mm and 28 mm. 2 crash bar clamps for lights, rubber inserts and mounting material are included in delivery.

NSW.00.004.13000/B

29.41 €



PRO- TECTION

Are you ready for your next big trip? Your machine is, too. Our protectors provide an extra helping of protection – from inadvertent ground contact, rocks or in case of a fall. The bike-specific guards fit seamlessly with the design of each bike and offer optimal ground and cornering clearance.

CRASH BARS	176
CRASH PADS	180
ENGINE GUARDS	184
HANDGUARDS	
LEVER GUARDS	190
OTHER PROTECTIVE PARTS	196



OFF TO ADVENTURE

You climb onto your bike and ride out into the backcountry. You leave everyday life behind and lose yourself in unknown terrain off the beaten track. It's fun, but there's some respect there, too. Respect for the harm that may come to you or your beloved bike. Whether you're deep in the woods or on a well-traveled highway, the result is the same: no-one wants a break-down. And a damaged engine component or case can not only be expensive, it can leave you stranded. We develop our crash bars, engine guards and crash pads in our workshop in Rauschenberg to prevent that.

All protective parts are carefully adapted by hand to the machine's lines. We work both directly on the bike and with the help of computer-aided design programs.

Take a crash bar, for example: it should fit perfectly and also look good. Ideally, it makes your bike look even better. In addition to the perfect fit, we also make sure that the crash bar can be mounted easily. The challenge here is to achieve a large protection area with as few load-bearing attachment points as possible.

In addition, the dynamics of the machine during travel and in case of a fall must be considered.



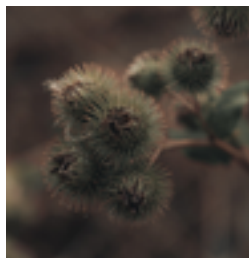

IT'LL TAKE A BEATING.

We design the crash bars in such a way that they offer sufficient cornering clearance and in case of a fall the vehicle rolls over the bar onto the handlebars without damaging the fairing or the engine area.

Development is followed by production in our plant in the Czech Republic.

Experienced metalworkers work here, who for twenty years have proven time and again what solid workmanship looks like. Thanks to modern CNC technologies, the welds and pipe bends in all our products are precise and solid, from the first part in the series, to the last.

The consistently high quality and reliability of the components are also guaranteed by the use of high-quality materials. SW-MOTECH works exclusively with high-quality steel and aluminum alloys. Additional powder coatings or brushing and polishing of the surfaces ensure the corrosion resistance of the protective parts.

For all major motorcycles, we offer a wide range of protection products suitable for the respective model and year of construction. In addition, SW-MOTECH offers a whole package of protection components for the current range of adventure and dual-sport motorcycles: the adventure sets contain crash bars, engine guard, crash pads and handguards.

With SW-MOTECH protection components installed on your bike, the protection of your machine is a given. Now you can focus on the important things, such as getting out on your next adventure!

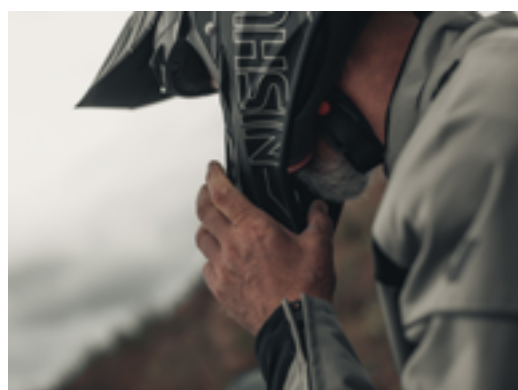

CRASH BARS

Whether your bike is a naked sportbike or an adventure touring machine, crash bars from SW-MOTECH provide the necessary extra safety for tank, fairing and other attachments. The elements manufactured specifically for the motorcycle model fit seamlessly into the appearance of the vehicle and at the same time offer optimum cornering clearance. Tailored add-on elements make it possible to attach things easily and reliably to original mounting points. Depending on the motorcycle model the crash bars are available in various design, material and color variations.

INCLUDED IN DELIVERY

2 crash bars, mounting material



Crash bar	starting at 92.44 €
-----------	---------------------

Adventure set protection	starting at 285.71 €
--------------------------	----------------------

Will it fit your motorcycle? Use the bike filter on [sw-motech.com](https://www.sw-motech.com)

PRO TIP:

For dual-sport and adventure bikes, we offer an attractively priced all-round carefree package with protectors for the most important components.

MATERIAL

- Robust steel construction
- Weather and corrosion-resistant powder coating

FUNCTION

- Reliable protection for important components
- Highly stable construction
- Model-specific development guarantees precise fit and reliable frame linkage
- Optimized lean angle guaranteed



Precision production for the motorcycle.



CRASH BARS FOR STREET BIKES

The crash bars for street bikes have more subtle lines tailored to the design of the motorcycle. Features durable powder-coated steel or stainless steel pipe construction and provides protection for key bike components.

Crash bar

starting at 92.44 €

Will it fit your motorcycle? Use the bike filter on [sw-motech.com](https://www.sw-motech.com)

STAINLESS STEEL CRASH BAR

The robust bracket made of stainless steel tubing with a wall thickness of 2.0 millimeters provides additional protection for the engine and important components against damage from falls and scratches. The use of blasted and electropolished stainless steel lends a noble length and ensures that the corrosion resistance of the crash bar remains intact even if it is damaged.

Stainless steel crash bar

starting at 168.07 €

Will it fit your motorcycle? Use the bike filter on [sw-motech.com](https://www.sw-motech.com)



CRASH BARS FOR TOURING BIKES

SW-MOTECH crash bars are specifically designed to fit individual motorcycle models. Some heavier-duty, more robust versions offer a bold, adventurous look and provide extra protection for rides on- and off-pavement. Available in stainless steel or powder coated steel depending on the model.

Crash bar

starting at 92.44 €

Will it fit your motorcycle? Use the bike filter on [sw-motech.com](https://www.sw-motech.com)

CRASH BARS MADE OF POWDER-COATED STEEL

The crash bars are made from steel pipe with a 22 or 27mm diameter with weather- and corrosion resistant powder coating in black, silver or orange to go with the respective motorcycle model. The surface finishing is carried out in a state-of-the-art facility in the SW-MOTECH factory in the Czech city of Brunn.

Crash bar

starting at 92.44 €

Will it fit your motorcycle? Use the bike filter on [sw-motech.com](https://www.sw-motech.com)





UPPER CRASH BARS

The upper crash bars primarily protect the motorcycle's fairing. Depending on the motorcycle model, they are made of powder-coated steel or stainless steel and are mounted as an addition to the SW-MOTECH crash bar or the original crash bar.

INCLUDED IN DELIVERY

2 upper crash bars, mounting instructions, mounting material



Upper crash bar

starting at 142.86 €

Will it fit your motorcycle? Use the bike filter on [sw-motech.com](https://www.sw-motech.com)

REQUIRED FOR MOUNTING:

Depending on the specific model, installation is only possible with SW-MOTECH crash bars or with the original crash bars of the manufacturer.

MATERIAL

- Robust steel construction
- Weather and corrosion-resistant powder coating

FUNCTION

- Fairing protection
- Bike-specific development guarantees a snug fit
- Simple, screw-on mounting on original attachment points



Fitted crash bar clamps for a secure hold.

FRAME SLIDERS

Additional protection in case of a fall is provided by the slider set for attaching to the frame. The shape, surface and material of the pads provide excellent sliding properties to reduce damage to the motorcycle. And if necessary, CNC-milled slider pads made from abrasion-resistant polyamide can be quickly exchanged.

INCLUDED IN DELIVERY

Crash pads, mounting material



Frame Sliders

starting at 75.63 €

Will it fit your motorcycle? Use the bike filter on [sw-motech.com](https://www.sw-motech.com)

PRO TIP:

In combination with the matching axle sliders, the frame sliders are a discreet solution for protecting sportbikes.

MATERIAL

- Well-shaped, exchangeable (if needed) slider pad made of abrasion-resistant polyamide
- Extremely solid, CNC-milled substructure made of aluminum alloy

FUNCTION

- Good sliding properties and emergency operating features
- Large contact surface for best-possible force distribution, protection of frame, engine and fairing
- Easy mounting and sturdy frame attachment thanks to bike-specific add-on elements



Good protection and design that fits the bike.





AXLE SLIDERS

The redesigned crash pads for the front and rear axle, made of abrasion-resistant plastic, protect the drive shaft and swing arm from damage in the event of a crash. The plastic core is now even more resistant with 30% glass fiber content. In combination with the TPE sheathing, the crash pads provide additional cushioning in case of unintentional contact with the road. The polished, red bull logo serves as a visual highlight on the motorcycle, and the axles made of high-quality steel with zinc-nickel coating guarantee long durability.

INCLUDED IN DELIVERY

Crash pad/s, mounting material



Slider set for front axle	starting at 50.42 €
Slider set for rear axle	starting at 37.82 €

Will it fit your motorcycle? Use the bike filter on [sw-motech.com](https://www.sw-motech.com)

PRO TIP:

The bike-specific protectors are available individually or in a set of two for the front and rear axles depending on the motorcycle model.

MATERIAL

- Robust core of fiberglass-enforced plastic (PA6 GF30) for high mechanical dampening capacity
- Matte black surface with polished bull logo in red
- Axles made of high-quality steel with zinc-nickel coating

FUNCTION

- Good sliding properties and emergency operating features
- Protects drive shaft and the swing arm
- Large contact surface for best possible force distribution
- Simple mounting on the front and rear axles



Glass fiber-reinforced plastic with damping TPE coating.

ENGINE GUARDS

Additional protection against rocks and contact with obstacles for the engine: the high-quality, aluminium alloy engine guard shows what it's capable of off the street, but provides extra safety and an individualized look on the streets, too. State-of-the-art production gives these bike-specific protectors a secure fit without affecting ground clearance. The installation on frame mounting points lends additional stability and allows for easy installation.

INCLUDED IN DELIVERY

Engine guard, mounting material



Engine guard	starting at 84.03 €
--------------	---------------------

Adventure set protection	starting at 294.12 €
--------------------------	----------------------

Will it fit your motorcycle? Use the bike filter on [sw-motech.com](https://www.sw-motech.com)

PRO TIP:

Adventure set protection: for dual-sport and adventure bikes, we offer an all-round carefree package with protectors for the most important components at an attractive price.

MATERIAL & FUNCTION

- Durable design made of high quality aluminum alloy
- Underbody protection from rock chips and collision
- Bike-specific development for perfect fit
- Reliable and easy installation on original attachment points, modifications to the motorcycle are not required









ENGINE GUARDS MADE FROM BRUSHED ALUMINIUM

The one-piece construction made of up to 5-mm thick aluminum, which matches the vehicle design, has inlets for ventilation of the engine block.

Engine guard

starting at 84.03 €

Will it fit your motorcycle? Use the bike filter on [sw-motech.com](https://www.sw-motech.com)

ENGINE GUARDS WITH POWDER-COATED OR ANODIZED PORTIONS

Some engine protection models are constructed from several elements. The black powder coating of the side pieces complements the design of the bike and is also extremely durable.

Engine guard

starting at 109.24 €

Will it fit your motorcycle? Use the bike filter on [sw-motech.com](https://www.sw-motech.com)



FRONT SPOILERS

With front spoilers, the focus is on the design of the bike above all, in addition to the protective function. For this reason, some models, like for this KTM 1290 Super Duke GT, are available with a powder coating that matches the color of the motorcycle.

Front spoiler

starting at 117.65 €

Will it fit your motorcycle? Use the bike filter on [sw-motech.com](https://www.sw-motech.com)





CYLINDER GUARD

If you love your boxer, you probably push it to its limits (hopefully only rarely). We spoil it with an extra dose of protection so you can keep it that way. These specially designed guards fit seamlessly into the design of the BMW and protect the boxer cover against damage from rocks and falls.

The protector can be easily mounted on existing attachment points. It consists of a laser-cut aluminium mounting bracket and a CNC-milled aluminium slider pad. It also has a rubber shock-absorber on the inside.

Cylinder guard

starting at 151.26 €

Will it fit your motorcycle? Use the bike filter on sw-motech.com

ENGINE CASE PROTECTOR

Made from milled aluminium alloy, this stylish guard protects the exposed right and left engine case from greater damage in case of ground contact or a fall.

The protectors are easily installed on original attachment points. They consist of a mounting bracket and slider pad, which can be replaced separately if needed.

Engine case protector

starting at 96.64 €

Will it fit your motorcycle? Use the bike filter on sw-motech.com



FRONT ENGINE GUARD EXTENSION

The engine guard extension protects the front area of the engine block from rock chips. Made from brushed and power-coated aluminium, the extension can be mounted on its own or in addition to an SW-MOTECH engine guard.

MSS.07.781.10100/B

58.82 €



ENGINE GUARD EXTENSION FOR CENTERSTAND

For some models, an engine guard extension is available. Depending on the vehicle, it is mounted with a few screws either on the SW-MOTECH or original centerstand.

Engine guard extension for centerstand

starting at 25.21 €

Will it fit your motorcycle? Use the bike filter on sw-motech.com

KOBRA HANDGUARDS

The KOBRA handguards' sturdy aluminum frame protects the rider in case of accidents and falls and the exchangeable handguard shells made of impact-resistant Moplen plastic offer additional protection against weather, stone chips and light brush.

INCLUDED IN DELIVERY

2 KOBRA handguards, mounting material



KOBRA handguard kit

starting at 84,03 €

Will it fit your motorcycle? Use the bike filter on [sw-motech.com](https://www.sw-motech.com)

MATERIAL & FUNCTION

- Handguard shells made from impact-resistant Moplen plastic
- Easy installation of the handguard shells on the aluminum bars
- Aluminum bar with bike-specific mounting kit for particularly robust two-point mounting
- Also available as a single-point mounting version depending on the model
- Modern design fits seamlessly into the look of the motorcycle



SINGLE-POINT MOUNTING

KOBRA handguards are also available with universal or bike-specific single-point mounting. Depending on the model the aluminium bars of the protectors are clamped to the handlebar or mounted to the handlebar end.

Single-point mounting

starting at 84.03 €

Will it fit your motorcycle? Use the bike filter on sw-motech.com



TWO-POINT MOUNTING

For many motorcycle models, the KOBRA handguards are available with particularly resilient two-point mounting.

Mounted on the handlebar and the bar end, the aluminium backbone is sturdy enough for your most demanding rides.

The sturdy aluminum backplate combined with the handguard shells made of impact-resistant plastic, offer the best protection for hands and levers off-road and in case of falls.

Two-point mounting

117.65 €

Will it fit your motorcycle? Use the bike filter on sw-motech.com

LED BLINKER SET

LED blinkers, available separately, offer increased visibility in traffic and can be easily placed in the recesses of the handguards. A resistor set is required for retrofitting the 10 or 20 watt blinkers to 1 watt KOBRA LED blinkers.

LED indicator set for KOBRA handguards	HPR.00.220.30000/B	42.02 €
Resistor set for LED indicators	HPR.00.220.30700/B	12.61 €

Will it fit your motorcycle? Use the bike filter on sw-motech.com



EXTENSION SET FOR KOBRA HANDGUARDS

The protective surface of the KOBRA handguards can be increased if necessary by an expansion made from impact-resistant plastic. The expansion is screwed onto the top edge of the KOBRA handguards. It fits seamlessly into the look of the bike, but still offers the hands considerably more protection from wind and weather, as the protective surface can be increased by 50%.

HPR.00.220.30100/B

16.81 €



LEVER GUARDS

The beautiful lever guards made from black anodized aluminum offer additional protection for brake and clutch levers. The high-quality forged components are available as a pair or inset with the impact-resistant wind guard shields. Thanks to the high-quality workmanship, they provide a stylish element on the handlebar and also protect during falls and accidents.

INCLUDED IN DELIVERY

2 lever guards, mounting material



Lever guards	109.24 €
Lever guards with windshield	130.25 €
Will it fit your motorcycle? Use the bike filter on sw-motech.com	

MATERIAL & FUNCTION

- Lever guards made from black anodized aluminum
- To be attached to the end of the handlebar
- Protection for brake lever and clutch lever
- Additional protection against falls and accidents



Lever guards with windscreen for improved protection.

BARKBUSTERS HANDGUARDS

The right hand protection for just about any bike: Barkbusters handguards are available in a variety of versions. From the particularly impact-resistant EGO model for trials and dual-sport riders to the all-weather BBZ model. A robust aluminum bracket serves as fall protection for your hands as well as brake and clutch levers.

INCLUDED IN DELIVERY

2 Barkbusters handguards, 2 sturdy aluminum brackets, mounting material

Barkbusters handguard kit

starting at 89.92 €

Will it fit your motorcycle? Use the bike filter on [sw-motech.com](https://www.sw-motech.com)



VERSIONS

- JET handguards: developed for dual sport, enduro and motocross machines
- EGO handguards: highly impact-resistant for use in motocross, trials and dual-sport riding
- VPS handguard: with windscreen that can be mounted in two positions
- Carbon fiber handguards: nice look, high stability and low weight



Handguard shells made from carbon fiber.



VPS handguard shells.

BARKBUSTERS HANDGUARDS			
STORM handguards	Large wraparound guard.	STM-003-00-BK	31.93 €
JET handguards	Ideal for bikes with long levers.		25.21 €
EGO handguards	Compact design.		27.73 €
VPS handguards	Plastic guard with variable height wind deflector. Ideal for bikes with		29.41 €
Carbon fiber handguards	Low weight handguard with unique style. Not compatible with EGO frames.	BCF-003-01-CF	151.26 €
Mounting kits	Including aluminum frame and mounting material. Universal or bike-specific.		starting at 42.02 €
Handguard kits	Including handguards, aluminum frames and mounting material.		starting at 89.92 €
BARKBUSTERS ACCESSORIES			
BBZ handguard kit	Sturdy fabric weather protection.	BBZ-001-01-BK	35.29 €
Bar end weight	Steel. Two-piece set.	B-066	13.45 €
Skid plate	For VPS and JET. Two-piece set.	VPS-002-00-BK	13.45 €
Bar end plug	Available in different colours. Two-piece set.		50.42 €
LED indicator light	Yellow. Fits JET, VPS and STORM. Two-piece set. ECE test mark.	LED-001-02-AM	50.42 €
LED position light	White. Fits JET, VPS and STORM. Two-piece set. ECE test mark.	LED-002-02-WH	50.42 €

MORE PROTECTIVE EQUIPMENT

WINDSCREEN

Made of brushed aluminium, this bike-specific windscreen gives the motorcycle a custom look. The solid construction consists of a silver anodized windscreen and a black powder-coated base unit that is mounted on the light mount or the fork crown, depending on model.

For individual models such as the Suzuki SV650, a completely black powder coated windscreen is available.

Windscreen	starting at 84.03 €
------------	---------------------

Does it fit your bike? Use our bike filter at [sw-motech.com](https://www.sw-motech.com)



WATER PUMP PROTECTION

The protector designed to fit the look of the bike can protect the water pump from damage due to accidental ground contact.

The water pump guard is made of highly stable aluminium alloy and is quickly and easily mounted on the original attachment points.

Water pump protection	84.03 €
-----------------------	---------

Does it fit your bike? Use our bike filter at [sw-motech.com](https://www.sw-motech.com)

BRAKE FLUID RESERVOIR GUARD

The brake fluid reservoir guard made from aluminum or stainless steel protects the original brake fluid reservoir guard against rock chips and prevents unintended removal of the lid at the same time. The protector can be installed on the motorcycle in a few simple steps.

Brake fluid reservoir guard	starting at 16.81 €
-----------------------------	---------------------

Will it fit your motorcycle? Use the bike filter on [sw-motech.com](https://www.sw-motech.com)





SCREEN REINFORCEMENT

Our screen reinforcement increases the contact surface and gives R1200 GS LC model windscreens additional stability. Windscreen flapping and rattling noises are noticeably reduced, along with the risk of vibration cracks. Original adjustment options are still possible.

SCT.07.174.10800/B

50.42 €

CHAIN GUARD

The SW-MOTECH chain guard is a high-quality alternative to the original plastic chain guard. The rubber-mounted attachment is easy to install. The mounting hardware is included in delivery.



Chain guard

starting at 33.61 €

Does it fit your bike? Use our bike filter at sw-motech.com



HEEL PROTECTOR

The component made from brushed aluminum protects motorcycle boots against hot exhaust or the swing arm's movements.

Heel protector

starting at 42.02 €

Does it fit your bike? Use our bike filter at sw-motech.com

OTHER PROTECTIVE PARTS

Brake reservoir guard	starting at 16.81 €
Brake cylinder guard	starting at 29.41 €
Fender-Kit	109.24 €
Heel guard	starting at 42.20 €
Extension for brake pedal	29.41 €
Sprocket cover	42.20 €
Chain guard	starting at 25.21 €
Radiator guard	starting at 42.21 €
Oil cooler guard	starting at 50.42 €
Clutch slave cylinder guard	37.82 €
Alternator cover guard	75.63 €
Engine case guard	96.,64 €
Potentiometer guard	29.41 €
EVO light guards	33.61 €
Side stand switch guard	starting at 21.01 €
Exhaust valve guard	29.41 €
Water pump guard	84.03 €
Windscreen	starting at 84.03 €

ERGO- NOMICS

For motorcyclists, good ergonomics help ensure a more enjoyable ride by providing a more comfortable seating position.

Especially for long tours, it's important to sit comfortably so you can concentrate on reaching your destination safely and without aches and pains. Our footrests, comfort cushions and products for positioning your handlebars increase your riding comfort and make riding even more fun.

FOOTRESTS	200
EXTENSION FOR BRAKE PEDAL	204
GEAR LEVER	206
BAR RISER	208
SEAT MODIFICATIONS	212
CUSHION	214





EVO FOOTRESTS

Is your original footrest impossible to position comfortably? If so, then the new EVO footrest from SW-Motech is the perfect solution. This sophisticated system, consisting of rotating elements with firmly interlocking teeth, gives you 36 options for positioning. The position of the footrest can be adjusted downward, forward and back and its angle is also fully adjustable so as to suit your individual needs.

INCLUDED IN DELIVERY

2 EVO footrests, 2 joint adapters, mounting material



EVO footrest kit

109.24 €

Will it suit your motorcycle? Use the bike filter on [sw-motech.com](https://www.sw-motech.com)

MATERIAL & FUNCTION

- Made from electropolished, corrosion-resistant cast stainless steel
- Easy mounting on original footrest mount
- Individual height adjustment (highest setting corresponds to the original position, lowering up to max. 15 mm possible)
- 36 adjustment options: downward, forward, and back, as well as angle adjustment thanks to the rotating interlocking elements
- A firm hold, thanks to the interlocking, bolted elements
- Markings make it easier to adjust both sides symmetrically
- Profile with rounded edges protects boot soles and provides extra grip at the same time
- Removable, metal-reinforced rubber top surface with anti-slip texture and large contact surface (approx. 8 x 5 cm/3.15 x 2 in) for extra comfort and grip



The individual components of the EVO footrest.



The EVO footrest without rubber overlay.



ION FOOTRESTS

Our reasonably priced ION footrest kits allow the footrest to be mounted at its original height or lowered by 15 mm. Extremely durable and built to last, these stainless-steel footrests provide plenty of extra grip and are recommended for adventure, offroad and urban motorcycles.

Hinges made from high-strength aluminum alloy ensure that the footrest can fold out of the way if the bike tips over. A removable rubber overlay reduces vibrations and the tread offers good grip even in offroad use.

INCLUDED IN DELIVERY

2 ION footrests, 2 joints, mounting material

ION footrest kit

84.03 €

Will it suit your motorcycle? Use the bike filter on [sw-motech.com](https://www.sw-motech.com)



MATERIAL & FUNCTION

- Made of corrosion-resistant cast stainless steel with removable rubber pad
- Profiled, anti-slip surface texture
- Easy mounting on original footrest mount
- Install the footrest at original height or 15 mm lower
- Large contact surface



The ION footrest with and without rubber overlay.



The ION footrest mounted.

FOOTREST EXTENSION FOR HONDA AFRICA TWIN

SW-MOTECH knows what off-road riders need! Developed exclusively for the Africa Twin, this footrest extension creates a total contact surface of 59 x 86 mm (the original AT footrest measures 40 x 65 mm). CNC-milled from a solid piece of aluminum for strength and precision fit. Increased surface area and lugged, but rounded teeth provide comfort and control for extended stand-up riding without tearing up boots.

INCLUDED IN DELIVERY

2 footrest extensions for Honda CRF1000L / CRF1100L Africa Twin, mounting material

Footrest extension for CRF1000L (15-17)	FRS.01.622.10000/B	84.03 €
Footrest extension for CRF1000L / Adv. Sports (18-) / CRF1100L (19-20)	FRS.01.890.10000/B	100.84 €

Will it suit your motorcycle? Use the bike filter on sw-motech.com



MATERIAL & FUNCTION

- Black anodized aluminum with laser-engraved, silver logo
- Extremely stable and high-quality look
- Enlarges the contact surface to 59 x 86 mm
- The CNC-milled profile with rounded edges protects boot soles and provides extra grip at the same time
- Easy mounting on the original footrest



Considerably enlarged contact surface.



Lasered SW-MOTECH logo.



EXTENSION FOR BRAKE PEDAL

The extension for brake pedal is ideal for off-road riding, because even when standing, it allows for a more well-controlled application of brakes. It complements the original brake lever appearance and allows both a widening and an increase of the overall contact surface area. This translates to better control and increased safety.

INCLUDED IN DELIVERY

Extension for brake pedal, mounting material

Extension for brake pedal

71.43 €

Will it suit your motorcycle? Use the bike filter on [sw-motech.com](https://www.sw-motech.com)



MATERIAL & FUNCTION

- To supplement the original brake lever appearance
- Raised and wider surface
- Improved grip thanks to ridged surface – even when wet and dirty
- Simple mounting with just two screws on to original brake pedal



Two height settings for contact surface



Widening of the contact surface of the foot

GEAR LEVER

Gear levers by SW-MOTECH combine specially selected materials and innovative design with perfect fit.

Our high-quality, aluminum alloy milled gear levers can be adjusted either freely or at preset lengths depending on your bike model to provide the perfect shifting position.

INCLUDED IN DELIVERY

Gear lever, mounting hardware

Gear lever		starting at 100.84 €
Extension for gear lever	FSC.00.127.10000/S	8.40 €
Will it suit your motorcycle? Use the bike filter on sw-motech.com		



MATERIAL & FUNCTION

- CNC-milled aluminum coated with HART-COAT®
- Gearshift holder is either freely adjustable or can be adjusted in intervals of 1, 2 or 3 centimeters (also beyond the original position)
- Spring mechanism allows the gear lever to fold in and protects against breakage in case of a fall



Laser engraved SW-MOTECH logo



Gear lever extension



BIKE-SPECIFIC HANDLEBAR RISERS

Change your seat position for more riding comfort: we offer bar risers adapted specifically to fit many specific bike models. The durable, CNC-milled or cast aluminum parts allow for various height changes with a perfect fit. An extension of the Bowden cables is not required.

INCLUDED IN DELIVERY

2 bar risers, 2 bar clamps, mounting material



Bike-specific handlebar risers

starting at 25.21 €

Will it suit your motorcycle? Use the bike filter on sw-motech.com

MATERIAL & FUNCTION

- Made from high-strength aluminum alloy, CNC-milled or cast
- Corrosion-proof anodized finish or powder coating
- Bike-specific design
- Available in silver or black
- No need to modify the cables



Bike-specific bar riser in black



Made from high-quality aluminum alloy

UNIVERSAL HANDLEBAR RISERS

We offer a universal bar riser that is suitable for a wide range of models. Made from high-quality aluminum alloy, these bar risers shift the handlebars upward by 15 to 50 mm depending on the model and are available in black or silver. These sturdy, weather-resistant bar risers fit on handlebars with a diameter of 22 or 28 mm.

INCLUDED IN DELIVERY

2 bar risers, 2 bar clamps, mounting material



Bar risers for Ø 22-mm handlebar					
15 mm	■	LEH.00.039.22001.15/B	■	LEH.00.039.22001.15/S	42.02 €
20 mm	■	LEH.00.039.22001.20/B	■	LEH.00.039.22001.20/S	42.02 €
25 mm	■	LEH.00.039.22001.25/B	■	LEH.00.039.22001.25/S	42.02 €
30 mm	■	LEH.00.039.22001.30/B	■	LEH.00.039.22001.30/S	42.02 €
50 mm	■	LEH.00.039.22001.50/B	■	LEH.00.039.22001.50/S	42.02 €
Bar risers for Ø 28 mm handlebar					
20 mm	■	LEH.00.039.24100.20/B	■	LEH.00.039.24100.20/S	42.02 €
30 mm	■	LEH.00.039.24100.30/B	■	LEH.00.039.24100.30/S	42.02 €
20 mm milled	■	LEH.00.039.20201/B	■	LEH.00.039.20201/S	84.03 €

Will it suit your motorcycle? Use the bike filter on sw-motech.com

MATERIAL & FUNCTION

- High quality aluminum alloy with black or silver powder coating
- Space between drill holes:
32 - 38 mm (Ø 22 mm) or 37 - 46 mm (Ø 28 mm)
- Handlebars with Ø 22 mm can be raised by 15, 20, 25, 30 or 50 mm
- For handlebars with Ø 28 mm: raise by 20 or 30 mm
- 50 mm rise is not approved for use on public roads in Germany



Mounted bar riser with SW-MOTECH logo



Bar riser in black



BIKE-SPECIFIC BAR BACKS

These bike-specific bar backs fit into the bike's design just as seamlessly as the bar risers. With a rise of 20 or 32 mm, the handlebar is shifted 25 or 30 mm, giving the rider an optimal seat position. High-quality anodizing protects the surface from scratches and weather conditions.

INCLUDED IN DELIVERY

2 bar backs, 2 bar clamps, mounting material

Bike-specific bar backs

starting at 63.03 €

Will it suit your motorcycle? Use the bike filter on [sw-motech.com](https://www.sw-motech.com)

MATERIAL & FUNCTION

- CNC-milled from high-strength aluminum alloy, black or silver anodized
- Bike-specific design

UNIVERSAL BAR BACKS

If you're having trouble reaching your handlebars comfortably, consider using a bar back. Our sturdy backs made from aluminum shift the handlebar upward by 30 mm and 21/22 mm to the back. For the rider, that can mean a more relaxed, back-friendly seating position, along with better control of the bike.

INCLUDED IN DELIVERY

2 bar backs, 2 bar clamps, mounting material

bar back for Ø 22 mm handlebar. H=30 mm. Changes position by 21 mm.

■ LEH.00.039.21001/B ■ LEH.00.039.21001/S 63.03 €

bar back for Ø 28 mm handlebar. H=30 mm. Changes position by 22 mm.

■ LEH.00.039.23100/B ■ LEH.00.039.23100/S 63.03 €

Will it suit your motorcycle? Use the bike filter on [sw-motech.com](https://www.sw-motech.com)



MATERIAL & FUNCTION

- High quality aluminum alloy with black or silver powder coating
- Back: 30 mm upward and 21/22 mm to the back.
- Space between drill holes: 32-38 mm (Ø 22 mm) or 37-46 mm (Ø 28 mm)

HANDLEBAR CONVERTER DIAMETER 22 MM TO 28 MM

The handlebar converter enables you to clamp a 28 mm handlebar in a 22 mm handlebar mount. With a height increase of 20 mm, the converter also provides additional riding comfort. Our handlebar converters are CNC-milled from high-strength aluminum alloy and have a bore distance of 30-37 mm.

INCLUDED IN DELIVERY

2 handlebar converters, 2 handlebar clamps, mounting hardware

bar converter diameter 22 to 28-mm handlebar			
H=20 mm	■	LEH.00.039.160/B	50.42 €
Will it suit your motorcycle? Use the bike filter on sw-motech.com			



FEATURES

- Converts handlebar mounts from Ø 22 mm to 28 mm,
- Space between drill holes: 30-37 mm
- Made from high-strength, CNC-milled aluminum alloy, black or silver anodized



VARIABLE BAR BACKS

Maximum flexibility: Vario bar backs allow for stepless adjustment of your handlebars forward and back, as well as variable height adjustment.

This gives you the utmost flexibility when adjusting your handlebars, along with your seat position.

INCLUDED IN DELIVERY

2 variable bar backs, 2 bar clamps, 2 extension pieces (10 mm), mounting material

Vario bar backs for Ø 22 mm handlebars			
■ LEH.00.039.170/B	■ LEH.00.039.170/S	84.03 €	
Vario bar backs for Ø 28 mm handlebars			
■ LEH.00.039.171/B	■ LEH.00.039.171/S	84.03 €	
Will it suit your motorcycle? Use the bike filter on sw-motech.com			

MATERIAL & FUNCTION

- Made of high-quality, CNC-milled aluminium alloy, black or silver anodized
- Variable height and back
- Raises bar by up to 60 mm (version available for Ø 28 mm handlebars)
- Spacer for optional 10 mm increase in height and mounting material included in delivery
- Not approved for use on public roads in Germany. Please check the rules in your country.

SEAT CONVERSIONS

A scrutinizing look, a few more staples, and it's ready. Elisabeth feels along the seat with her hand, checks one last time that the seams are all perfectly symmetrical, the cover is evenly stretched and the SW-MOTECH bull is exactly in the middle. A converted seat does not leave our house until our saddlers are 100% satisfied with their work.



Since the start of the 2018 season, we've been building seats at our seat factory in Rauschenberg by hand. Naturally, only carefully selected materials are used. Before work begins, the customer decides on one of the three seat shapes. The options are "Standard", "Racing" or "Touring". And that's just the beginning, because the individual scope for design is so widely varied.



Our team of saddlers changes the shape, bolstering it up or upholstering it and using a harder foam or spacer fabrics for greater comfort. We offer 15 types of tough, UV-resistant synthetic leather that are specially manufactured for the motor vehicle sector. There are also nine tread colors to choose from and you can add piping, diamond stitching or double stitching to the seat (optional).



Sounds complicated, right? But it's not. The configuration tool in our online shop guides you step by step through all options and always shows you changes in design and price with each modification. Order, send in your seat free of charge and after 10-15 working days, we will send your converted seat back. And as with all SW-MOTECH products, you get the best quality at a fair price.



For custom-made products, e.g., Honda Goldwing seats, we are happy to provide a customized offer on request.



CONFIGURATION

Choose the desired shape, materials and the individual design of your seat in our online configurator: you can choose from 15 robust imitation leather surfaces and yarns in nine different colors. You can also choose from different types of stitching and upholsteries. Then send us your modification order.

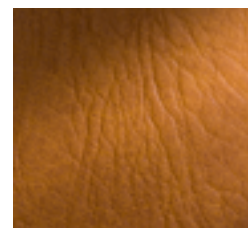

SHIPPING TO SW-MOTECH

As soon as we receive your order, we will send you a shipping box containing packaging material and a prepaid returns form. When you receive the box, put your seat in it, stick the returns form on the front and take it to your nearest DHL drop box. We will cover the shipping costs. Please keep the posting receipt.



MODIFYING YOUR SEAT

This is when the work really starts in our seat factory. We build your seat based on your specifications and from the finest materials, that have been specially selected for use on motorcycles. This takes between ten to fifteen business days.



YOUR SEAT IS READY

As soon as we have finished modifying your seat, we will package it and send it on its way. A few days later, you can mount your newly designed seat on your bike and off you go...

CONFIGURE NOW:
SW-MOTECH.COM/SEAT+MODIFICATIONS

TRAVELLER COMFORT CUSHION

Enjoy long rides from start to finish: the TRAVELLER comfort cushion with an air cushion made of durable polyurethane relieves your back and behind. The comfortable, vibration dampening bench seat supports good blood circulation and prevents painful pressure points. The air weaving and breathable spacer fabric also reduces heat and sweat build up. The comfort cushions match specific bike models based on the shape of the seat.

INCLUDED IN DELIVERY

TRAVELLER comfort cushions

TRAVELLER PILLION cushion	SIK.00.410.10100/B	75.63 €
TRAVELLER RIDER cushion	SIK.00.410.10000/B	84.03 €
TRAVELLER SMART cushion	SIK.00.410.10200/B	100.84 €

Will it suit your motorcycle? Use the bike filter on sw-motech.com



MATERIAL

- Surface made of rugged, bi-elastic artificial leather for extra sitting comfort
- Waterproof polyurethane air cushion

FUNCTION

- TRAVELLER comfort cushions are available in three styles - suitable for almost all bikes and sitting positions
- Integrated vent allows for variable air filling
- Two sturdy straps with ROK™ straps and anti-slip underside for precise positioning
- Anti-theft protection by attachment under the seat



All-round retaining straps for safe positioning

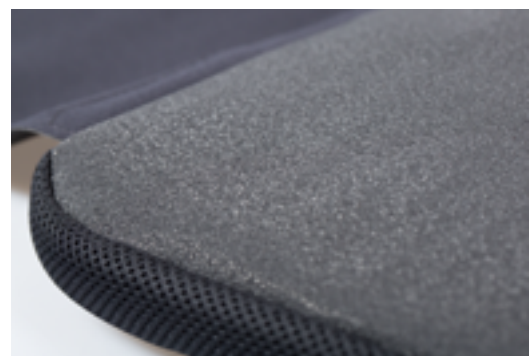

Air pockets reduce heat and sweat formation



THE RIGHT PADDING FOR EVERY MOTORCYCLE

- TRAVELLER RIDER for sporty touring bikes
- TRAVELLER PILLION for straight bench seats or the passenger seat
- TRAVELLER SMART for choppers and cruisers

PERFECT FIT

- The anti-slip underside and circumferential retainer strap guarantee secure positioning of the seat cushion.
- Anti-theft protection by attachment under the seat
- The bi-elastic, rugged artificial leather surface provides extra sitting comfort.



PROVEN PATENT

- Patent pending: innovative mounting system with integrated ROK™ Straps
- Thanks to high quality workmanship and highly durable materials, TRAVELLER comfort cushions will enhance riding enjoyment for many years.



AN AIRY SOLUTION

- Reduced heat and sweat formation due to the breathable spacer fabric of the cover and inner padding with interconnected air chambers
- The air volume can be adjusted via an integrated vent for more comfort or a more responsive feel on curvy roads.

NAVI GATION

Helping you stay on the right track, our solutions help you to ideally position your GPS or smartphone in your motorcycle cockpit. With a variety of mounting options, we offer a suitable system for practically any motorcycle.

GPS HOLDERS	218
T-LOCK	220
NAVI CASE & PHONE CASE	223
UNIVERSAL KITS	224
NAVI CASE PRO	226
FURTHER NAVIGATION PRODUCTS	227
POWER SUPPLY	228



MODEL-SPECIFIC GPS HOLDER

Our vehicle-specific GPS mounts combine clever positioning, vibration damping and easy removal. In order to provide the best possible view of your instruments and GPS, the GPS mount is attached to the handlebar mount, to struts or to another position in the cockpit, depending on the motorcycle model. The swiveling mount can be removed in one easy step and, thanks to its universal hole pattern, gives many current GPS devices as secure a hold as our Phone / Navi Case and Navi Case Pro device cases

INCLUDED IN DELIVERY

1 model-specific GPS mount, mounting material



Model-specific GPS mount/holder

starting at 29.41 €

Will it suit your motorcycle? Use the bike filter on [sw-motech.com](https://www.sw-motech.com)

MATERIAL

- GPS mount made of black powder-coated steel with locking mechanism made of fiberglass-reinforced plastic

FUNCTION

- Removable and vibration-damping
- Easy mounting on existing mounting points in the cockpit, on the handlebar mounting bolts, the handlebar center brace or other tubes with a diameter of Ø 10/12 mm
- Pivotable for ideal view of devices
- Retaining plate with universal hole pattern gives the usual GPS models and Phone / Navi Case and Navi Case Pro device cases or hard cases from SW-MOTECH a secure hold
- Made to fit each bike model for optimal positioning

MODEL-SPECIFIC MOUNTING



GPS MOUNT ON THE HANDLEBAR

In this version, the holder is mounted on the bar mount. The removable GPS mount is pivotable and gives the rider the best view of their GPS device.

GPS MOUNT FOR COCKPIT

To achieve optimal positioning, a powder-coated steel plate securely attaches the GPS mount to original connection points in the cockpit.



GPS MOUNT ON TUBE \varnothing 10/12, 13/16, 17 MM

Crossbars, windshield mounts or other bars in the cockpit can provide the ideal connection point for mounting your GPS device, depending on your bike model. For these models, the removable GPS mount with clamp is available for tubes \varnothing 10/12 mm, 13/16 mm and 17 mm in diameter.

T-LOCK

MOLLE provides a solid and flexible way to configure and organize your luggage. But some things need to be detached and re-attached often. This where the T-LOCK comes in.

Once mounted to the respective MOLLE sides, the T-LOCK allows a quick, one-handed quarter-turn mount and dismount for frequently used items such as a phone or navi case.

The T-LOCK system works so well, expect to see this attachment system used as a standard connection mechanism in future SW-MOTECH products.

In fact, the lower T-LOCK holder can already be attached to the swiveling clamp arm anywhere on the handlebars. Now you can position a phone or GPS navigation device in a variety of ways to suit your needs. And now your device is accessible with a flick of the wrist.

Always by your side: thanks to their easy handling, PRO tank bags are a practical companion even during breaks.



T-LOCK HOLDER

Want to attach an accessory bag to the MOLLE system quickly and easily? Just put on the T-Lock, turn 90 degrees clockwise and the case is fixed.

Via a twist lock, the T-Lock holder with MOLLE adapter connects small accessory bags such as the PRO Pocket with tail bags and tank bags that are fitted with a MOLLE system. The MOLLE attachment system is used for all PRO series' tank bags and tail bags, as well as for numerous bags from the Legend Gear series. This gives you more flexibility when transporting luggage and you can pick and use your bags depending on your own needs.

The T-Lock consists of two parts: The lower part of the T-Lock on your bag's MOLLE attachment is secured by means of a star-shaped adapter. The top is looped once on your accessory bag. After that, you can secure the T-Lock with a swift hand movement.

INCLUDED IN DELIVERY

1 T-Lock holder



T-Lock holder	TL.00.940.10000	16.81 €
---------------	-----------------	---------

Will it suit your motorcycle? Use the bike filter on sw-motech.com

MATERIAL & FUNCTION

- Solid and durable plastic construction
- Simple attachment via twistlock
- Designed for universal use with the MOLLE system



The T-Lock holder on the PRO Micro tank bag.



PHONE CASE AND NAVI CASE

The two splash-proof device cases Navi Case and Phone Case offer impressive practical features.

The covering sleeve with sun visor allows the operation of the touchscreen. Velcro® straps in the padded case stabilise your device and the all-round zipper allows easy opening. A rubber lining keeps out moisture. With the T-Lock holder on the back, you can quickly and easily attach the case to the appropriate holders.

The exact outer and inner dimensions of the two cases can be found on our website in the navigation section.

In stores starting early 2021.

INCLUDED IN DELIVERY

Phone Case / Navi Case

Phone Case	BC.GPS.00.010.10000	16.81 €
Navi Case	BC.GPS.00.011.10000	16.81 €

Will it suit your motorcycle? Use the bike filter on sw-motech.com



TIP:

The T-Lock receptacle on the back of the housing allows for quick mounting. With a quarter turn clockwise the Navi Case / Phone Case is fixed.

MATERIAL & FUNCTION

- Navi Case for devices in landscape format
- Phone Case for devices in portrait format
- Made of dimensionally stable EVA material
- With T-Lock receptacle on the back
- Whether all functions of the touch control panel can be used depends on the device model (e.g. fingerprint sensor)
- Touchscreen operation window
- Durable shell with reinforced base plate
- Removable inner padding
- Foam rubber inserts and Velcro® strips for positioning the GPS
- Cable opening
- All-round, water-repellent zipper – can be stowed away securely



UNIVERSAL KITS

For conveniently mounting electronic devices like smartphones, GPS devices or GoPros in the cockpit, we offer a range of clever solutions. Our universal kit offers a variety of different attachment options: the provided 1" ball can be mounted on a M6 or M8 thread, on a mirror thread holder or with a mounting clamp. The mounting clamp is designed for handlebars with a diameter of 22.28 mm or 1 in. A pivoted socket arm makes positioning in the cockpit easy - so the display always remains in plain sight, without obstructing instrument view. The T-Lock holder on the clamp arm allows for quick attachment of the Navi Case and Phone Case.

INCLUDED IN DELIVERY

1 mounting clamp, 1 ball with M8 thread and M6 converter, 1 holder for mounting on mirror thread, 1 2" clamp arm, 1 T-Lock holder, 1 ball joint with mounting plate, depending on the kit additionally a Navi Case / Phone Case or a RAM X-Grip clamp, mounting material



Universal kits		
Universal GPS mount kit with T-Lock	GPS.00.308.35000	42.02 €
Universal GPS mount kit with Phone Case	GPS.00.308.35100	50.42 €
Universal GPS mount kit with Navi Case	GPS.00.308.35200	50.42 €
GPS mount kit with ball clamp and T-Lock	GPS.00.308.35400	42.02 €
Universal GPS mount kit with Smartphone Drybag	GPS.00.308.35500	50.42 €
Universal X-Grip-Kit for large Smartphones	GPS.00.308.30500/B	75.63 €
Universal GoPro camera kit	CPA.00.424.12501/B	42.02 €

Will it suit your motorcycle? Use the bike filter on sw-motech.com

TIP:

The T-Lock receptacle on the back of the Navi Case / Phone Case allows for quick attachment to the Universal Navi Kit. A quarter turn clockwise fixes the Navi Case / Phone Case to the clamp arm.

MATERIAL & FUNCTION

- Complete set for mounting GPS devices, smartphones or GoPro cameras
- Balls and 2" socket allow for individual positioning
- T-Lock holder for quick mounting of Navi Case / Phone Case Pro
- 1" ball can be mounted on a M6 or M8 thread, on the mirror thread holder or with a mounting clamp
- Mounting clamp for handlebars with a diameter of 22.28 mm or 1"
- Hole pattern for GPS mount is compatible with hardcases and Navi Case Pro from SW-MOTECH and common GPS devices



1" ball for M6 or M8 thread.



Swiveling clamp arm on the 1" ball holder.



UNIVERSAL GPS KIT WITH PHONE CASE

This all-round carefree package includes a weatherproof Phone Case, which is attached to the T-Lock. Our universal kit offers a variety of different attachment options: the provided 1" ball can be mounted on a M6 or M8 thread, on a mirror thread holder or with a mounting clamp.

UNIVERSAL GPS KIT

Our universal kit offers a variety of different attachment options: the provided 1" ball can be mounted on a M6 or M8 thread, on a mirror thread holder or with a mounting clamp. The mounting clamp is designed for handlebars with a diameter of 22/28 mm or 1 inch. A pivoted socket arm makes positioning in the cockpit easy - so the display always remains in plain sight, without obstructing instrument view.



UNIVERSAL X-GRIP KIT

This versatile kit can be used to securely attach a large smartphone to almost any motorcycle. The X-Grip clamp impresses with its versatility - it gives smartphones a secure hold and can be flexibly aligned on a socket arm with the 1" adapter ball.

NAVI CASE PRO

The two water resistant device cases Navi Case and Phone Case convince with their practical features.

The covering sleeve with sun screen allows the operation of the touchscreen.

Velcro® straps in the padded case stabilise the hardware and the all-round zipper allows easy opening. The rubber lining keeps out moisture. With the universal mount on the back, the Navi Case Pro can be firmly screwed to the Universal Navi Kit or to model-specific GPS mounts.

The exact outer and inner dimensions of the two cases can be found on our website in the navigation section.

INCLUDED IN DELIVERY

Navi Case Pro S / M

Navi Case Pro S	BC.GPS.00.007.10000	12.61 €
Navi Case Pro M	BC.GPS.00.008.10000	12.61 €
Universal GPS mount kit with Navi Case Pro S	GPS.00.308.30401/B	50.42 €
Universal GPS mount kit with Navi Case Pro M	GPS.00.308.30002/B	50.42 €

Will it suit your motorcycle? Use the bike filter on sw-motech.com

MATERIAL & FUNCTION

- Touchscreen operation window
- Whether or not all functions of the touchscreen can be used depends on the specific device model (e.g. fingerprint sensor).
- Durable shell with reinforced base plate
- Universal mount on the back of the housing
- Cable opening
- All-round, water-repellent zipper – can be stowed away securely
- Removable inner lining, foam rubber inserts and Velcro straps to position the GPS device
- Holder required for mounting: compatible with GPS mounts, universal kits and clip adapters from SW-MOTECH, holders with Richter adapter plate and RAM systems



REQUIRED FOR MOUNTING:

Holder required for mounting. Compatible with GPS mounts, universal kits and clip adapters from SW-MOTECH, holders with Richter adapter plate and RAM systems. Not compatible with T-Lock.





GPS MOUNT WITH HANDLEBAR CLAMPS

With this GPS mount with handlebar clamp, motorcycle GPS devices can be attached to tubular handlebars with different diameters. The aluminium clamps are available in brushed, polished or black anodized finishes to match the look of your bike. Special rubber shock absorbers between the handlebar clamps and the device holder protect against vibration and impact.

INCLUDED IN DELIVERY

GPS mount with handlebar clamp, mounting hardware

GPS mount with handlebar clamps		
For handlebars Ø 22 mm in diameter	■ GPS.00.308.10001/B	25.21 €
For handlebars Ø 22 mm in diameter	■ GPS.00.308.10001/S	25.21 €
For handlebars 28 mm in diameter	■ GPS.00.308.10201/S	25.21 €
Für Lenker 1 1/4" (Ø 32 mm)	■ GPS.00.308.10301/S	25.21 €

MATERIAL & FUNCTION

- Handlebar clamp made of aluminum
- For handlebars with 22/25.4/28/32 mm diameters
- Universal hole pattern
- Pivotal upper part makes it easy to position in the cockpit
- Vibration-damping

CLIP ADAPTER FOR GPS MOUNT

This clip adapter lets you quickly attach and remove Navi Case Pro cases and GPS devices to and from any GPS mount from SW-MOTECH. The upper part of the adapter is attached to the device or device case and the opposite side can be simply attached to the GPS mount.

INCLUDED IN DELIVERY

1 adapter plate male, 1 adapter plate female

Clip adapter for GPS mount	GPS.00.308.10501/B	14.29 €
----------------------------	--------------------	---------

MATERIAL & FUNCTION

- Plastic with M4 brass thread bushings
- Holder required for mounting: compatible with all GPS mounts from SW-MOTECH, universal kits and holders with Richter adapter plate and RAM systems
- Dimensions: 57 x 42 x 12 mm



ACCESSORIES

POWER SUPPLY



DOUBLE USB CHARGING SOCKET WITH CABLE HARNESS

With this dual USB charging socket you can operate and charge GPS devices, digital cameras, smartphones and tablets.

The high-quality dual USB socket and the completely insulated cable harness are protected from water spray by rubber seals.

2,000 mA / 5 V For 12 V car operating voltage	EMA.00.107.11300	25.21 €
---	------------------	---------

UNIVERSAL ELECTRONICS KIT

The cigarette lighter outlet of the universal electronics kit connects directly to the bike's power system. You can charge your smartphone or GPS device using the included USB adapter.

The mounting bracket can be attached to virtually any handlebar using the included hardware or you can install directly to your bike's fairing.

EMA.00.107.20001/B	33.61 €
--------------------	---------





CIGARETTE LIGHTER OUTLET WITH CABLE HARNESS

No built-in power socket? No problem! This cigarette lighter outlet connects to your bike's battery with the supplied cable harness. The high-quality socket and fully insulated cable harness are protected from splash water by rubber gaskets. For mounting the cigarette lighter, we recommend separately available mounting plates that can be attached to the handlebar mount with M8 or M10 screws.

Cigarette lighter outlet/socket	EMA.00.107.10200	16.81 €
Mounting plate M8	EMA.00.107.12300	12.61 €
Mounting plate M10	EMA.00.107.12400	12.61 €

EVO LIGHT SWITCH FOR COCKPIT

The green-illuminated, splash-proof on/off switch is connected via an insulated cable with three plug connections. This compact switch can be attached to barrel handlebars with Ø 22 mm up to 1 inch (25.4 mm).

For fog lights	EMA.00.107.12900	16.81 €
For high-beam headlights	EMA.00.107.12800	16.81 €

MATERIAL & FUNCTION

- Splash-proof (protection class IPX4)
- Cable length 30 cm
- For 12 V Car operating voltage
- Also available as blue version for high beam lights
- The switches are already included in the delivery with the EVO headlights





GEAR SHOP

T-SHIRT STREET LINE

This gray t-shirt is dominated by the red and gray SW-MOTECH bull, front and center. The t-shirts, available in five sizes, are made from high quality organic cotton. The casual cut, short sleeves and round neckline creates an excellent fit for men or women.



16.81 €



HOODED SWEATSHIRT STREET LINE

This heather gray hoodie is one of our favorite pieces. Made from 60% cotton and 40% polyester, it is comfortable to wear and holds its shape even after several washes. A large, red and gray SW-MOTECH bull is displayed on the chest. All of the hoodie essentials such as the front kangaroo pocket and hood drawstring are here. Thanks to the knapped inner side, it is especially comfortable to wear. The hooded sweatshirt is available in five sizes and, with its unisex shape, it's equally popular with men and women.

42.02 €

KNITTED FLEECE JACKET

The mottled dark gray fleece jacket is beautifully cut and just the right thing for the transitional period or as a base layer. It has a continuous zipper and three additional zipper pockets.

58.82 €





LEGEND GEAR T-SHIRT

This black t-shirt features a cool distressed look print on the chest and a Legend Gear logo on the back.

The top made from pure cotton is easy-care and offers maximum comfort. The crew neck and short sleeves make this a casual basic that goes well with anything. Ladies' shirts have a figure-hugging cut.

16.81 €

TEAM CAP

The stylish SW-MOTECH cap with stitched logo can be individually adjusted to head size. The cut and material offer excellent wearing comfort.



WER.GIV.006.10000

4.20 €



SW-MOTECH MUG

Our SW-MOTECH cup is one of the absolute bestsellers in our fan shop. A good start to the day is guaranteed and motorcyclists can warm their hands and heart, even in bad weather.

WER.GIV.024.10000

4.20 €

T-shirt	Street Line. Gray. Unisex.		16.81 €
Knit fleece jacket	Core Line. Black. Men. 100% polyester.		58.82 €
Knit fleece jacket	Core Line. Black. Women. 100% polyester.		58.82 €
Hooded sweatshirt	Street Line. Gray. Unisex. 60% cotton, 40% polyester.		42.02 €
T-shirt	Legend Gear. Black. Men. 100% cotton.		16.81 €
T-shirt	Legend Line. Black. Women. 100% cotton.		16.81 €
SW-MOTECH promotional cup	Red. Matt. With bull and url.	WER.GIV.024.10000	4.20 €
Team Cap	Black. 100% cotton. Adjustable size.	WER.GIV.006.10000	4.20 €
SW-MOTECH decal set	310x260 mm. Plot set. Red/black. Weather-/UV-resistant.	WER.GIV.016.10001	8.40 €
SW-MOTECH decal set	310x260 mm. Plot set. Red/white. Weather-/UV-resistant.	WER.GIV.017.10001	8.40 €
Legend Gear cap	Black. 100% cotton. With mesh insert. One-size.	WER.GIV.021.10000	8.40 €
Multi-tool key chain attachment	Stainless steel. Silver. With logo	WER.GIV.022.10000	8.40 €
Scarf	50 x 25 cm. Black/red. 100% polyester. Seamless.	WER.GIV.023.10002	4.20 €
3D key ring tank bag	40x30 mm. PVC. In non-woven bag.	WER.GIV.033.10000	4.20 €
SW-MOTECH sticker bulls	130 x 97 mm. Reflective. Red.	WER.GIV.031.10000	2.52 €
3D key ring	35 mm in diameter. Thickness:10 mm.	WER.GIV.032.10001	1.68 €
SW-MOTECH bike carpet	2.0 x 1.0 m. Rectangular. Black. Print white/red.	WER.POS.001.10001	67.23 €

GENERAL SALES TERMS AND CONDITIONS

**General sales terms and conditions of
SW-MOTECH GmbH & Co. KG
Ernteweg 7-10, 35282 Rauschenberg
Germany**

§ 1 General, sphere of applicability

(1) These General Sales Terms and Conditions (GSTAC) shall apply to all our business relationships with our customers (hereinafter referred to as the "Purchasers"). The General Sales Terms and Conditions shall apply only if the Purchaser is an entrepreneur (section 14 BGB1), a legal entity under public law or a special fund under public law.

(2) The General Sales Terms and Conditions shall apply in particular for contracts governing the sale and/or the delivery of moveable items (hereinafter referred to as the "Goods") without any consideration of whether we produce the Goods ourselves or buy them from suppliers (sections 650 BGB). The General Sales Terms and Conditions shall apply in the particular version concerned as a framework contract also for future contracts governing the sale and/or delivery of moveable items with the same Purchaser without our having to draw attention to this in each individual case; we shall inform the Purchaser in such a case without delay about any amendments to our General Sales Terms and Conditions.

(3) Our General Sales Terms and Conditions shall apply exclusively. Any deviating, contrary or supplementary general terms and conditions of the Purchaser shall only become a part of this Contract then and inasmuch as we have expressly agreed to their application. This requirement for agreement shall apply in every case, for example also if we carry out delivery to the Purchaser without reservation and with knowledge of the Purchasers general terms and conditions.

(4) Any individual agreements made with the Purchaser in the individual case (including ancillary arrangements, supplements and amendments) shall always have priority over these General Sales Terms and Conditions. For the content of such agreements, an agreement made in written form or our confirmation given in written form shall be decisive.

(5) Declarations and notices of legal significance which are to be given to us by the Purchaser after conclusion of contract (e.g. the setting of periods, notices of defect, declaration of withdrawal or reduction) require written form to be effective.

(6) Indications to the applicability of statutory regulations only have clarifying significance. Even without such clarification, the statutory regulations shall apply therefore without their being amended directly or excluded expressly in these General Sales Terms and Conditions.

(7) For orders through our online shop, the indications given there shall be observed separately.

§ 2 Conclusion of Contract outside the online shop

(1) For the conclusion of contract through our online shop, the "General Terms and Conditions for Purchases in the Online Shop" included there shall apply.

(2) Our offers outside the online shop are subject to confirmation and non-binding. This shall also apply when we have given the Purchaser catalogues, technical documentation (e.g. drawings, plans, calculations, references to DIN norms), other product descriptions or documents – also in electronic form – in which we reserve title and copyright.

(3) The acceptance of the offer of purchase may be declared by us to the Purchaser either in written form or through delivery of the Goods to the Purchaser.

§ 3 Delivery dates

(1) Delivery dates or periods, which have not been expressly agreed as binding, are exclusively nonbinding offers.

(2) Inasmuch as we cannot keep to binding delivery periods for reasons for which we do not bear the responsibility (non-availability of service), we shall inform the Purchase about this without delay and, at the same time, give notice of the probably, new delivery period. If the service is not available even within the new delivery period, we are entitled to withdraw either fully or partly from the Contract; any already provided counter performance of the Purchaser shall be refunded without delay. Any self-delivery by our suppliers shall be regarded as non-availability in these terms if we have concluded a congruent hedge transaction, neither we nor our suppliers have

incurred any fault and we are not obliged to procurement in the individual case.

(3) The rights of the Purchaser in accordance with section 8 of these General Sales Terms and Conditions and our statutory rights, in particular in case of exclusion of the obligation of service (e.g. due to impossibility or unreasonableness of service and/ or subsequent performance), are not affected.

§ 4 Delivery, transfer of risk, return of Goods free of defects

(1) Delivery shall take place ex works which shall also be the place of performance. On request by and at the expense of the Purchaser, the Goods shall also be sent to another place of destination (sale to destination). Inasmuch as nothing else has been agreed, we are entitled to determine the type of shipping (in particular the carrier, the despatch route, packaging) ourselves.

(2) The risk of accidental destruction or accidental deterioration of the Goods shall be transferred at the latest on being handed over to the Purchaser. In the case of sale to destination, however, the risk of accidental destruction or accidental deterioration of the Goods and the risk of delay shall be transferred to the carrier or the haulage contractor already on delivery of the Goods to the carrier or the haulage contractor.

(3) There is no take-back obligation for Goods delivered free of defects. If we declare that we are prepared, by way of fairness, to take back Goods which are in faultless condition and in their original packaging, a Goods credit deducting a restorage fee of 10% of the calculated price shall be made after the Goods have been received by us and the Purchaser has provided verification of delivery. If the Goods have been unpacked but are complete and undamaged, 20% of the calculated price shall be deducted for control, packaging and re-storage work. There shall be greater deduction if the Goods are incomplete and/or damaged whereby in such cases we reserve the right to refuse to take back the Goods.

Any set-off shall only be permitted after credit has been given. Before return of the Goods in the case of being taken back for reasons of fairness, the Purchaser shall request a RMA number (Return Merchandise Authorisation) as the Goods shall be quickly and correctly assigned by us on receipt.

§ 5 Prices, payment conditions

(1) Inasmuch as, in the individual case, nothing else has been agreed, our current prices, which are applicable at the point of time of conclusion of contract, shall apply ex store plus the statutory VAT. (2) In the case of sale to destination (section

4 sub-section 1), the Purchaser shall bear the transport costs ex store and the costs of any transport insurance if desired by the Purchaser. Any customs duties, charges, taxes or other public levies shall be borne by the Purchaser. We shall not take back any transport or any other packaging costs in accordance with the stipulation of the Packaging Regulation; they shall become the property of the Purchaser with the exception of pallets.

(3) Our invoices are due on issuance and payable net without deduction. Any other payment period requires separate agreement. We reserve the right to request advance payment in individual cases. If direct debit has been agreed, the payment amount shall be due one day after the receipt of invoice unless a different due date has been stated on the invoice. Advance information of direct debit (SEPA pre-notification) shall take place together with the invoice. Receipt of advance information, at the latest one day before due date is sufficient (debit of invoice sum). We are entitled to demand interest amounting to the credit costs that we have to pay, but to at least one percent per month, from the Purchaser, who is a businessman in the terms of the Commercial Code (HGB), from due date onwards and from the Purchaser, who is not a businessman, from default onwards.

(4) The Purchaser shall only have the right to setoff or retention inasmuch as his claim has been established with legal effectiveness or is undisputed. In the case of defects in the delivery, the counter rights of the Purchaser, in particular in accordance with section 7 sub-section 6 sentence 2 of these General Sales Terms and Conditions, remain unaffected.

§ 6 Reservation of title

(1) Up until full payment of all our present and future demands from the Purchase Contract and a current business relationship (secured demands), we reserve title in the sold Goods.

(2) The Goods, which are subject to reservation of title, may neither be assigned to third parties before full payment of the secured demands, nor transferred for security. The Purchaser shall notify us without delay and in writing if and inasmuch access by third parties to Goods, which belong to us, takes place.

(3) In the case of behaviour on the part of the Purchaser contrary to contract, in particular in the case of non-payment of the due purchase price, we shall be entitled, in accordance with the statutory regulations, to withdraw from the Contract and/or demand surrender of the Goods on the basis of the reservation of title. A demand for surrender does not at the same time mean withdrawal; rather we are entitled to demand

surrender of the Goods and reserve the right to withdrawal. If the Purchaser does not pay the due purchase price, we may only assert these rights if we have previously set the Purchaser a reasonable period for payment without success or such setting of a period is not necessary in accordance with the statutory regulations.

(4) The Purchaser is entitled to resell and/or process the Goods, to which title is reserved, in the correct course of business. In such a case, the following provisions shall apply in addition:

(a) reservation of title shall extend to products arising from the processing, mixing and combining of our Goods to their full value, in which case, however, we shall be regarded as the producer. If, in processing, mixing or combining them with the Goods of third parties their right to ownership remains, we shall acquire co-ownership in the ratio of the invoice value of the processed, mixed or combined Goods. Otherwise, the same shall apply to the product emerging as to the Goods delivered under the reservation of title.

(b) The Purchaser shall assign demands arising from re-sale of the Goods or the products against third parties already now in full or at the amount of any co-ownership share of ours in accordance with the above paragraph as surety to us. We accept such assignment. The duties of the Purchaser stated in sub-section 2 shall also apply in view of the assigned demands.

(c) The Purchaser is also authorised to collect the demand as well as we are. We undertake not to collect the demand as long as the Purchaser meets his payment obligations towards us, does not come into default of payment, no application for the opening of insolvency proceedings has been made and no other defect in his efficiency is apparent. If this is the case, however, we may demand that the Purchaser notifies us of the assigned demands and their debtors, supplies all information necessary for collection, hands over the appropriate documents and notifies the debtors (third parties) of assignment.

(d) If the realisable value of the sureties exceeds our demands by more than 10%, we shall release sureties in accordance with our choice on request by the Purchaser.

§ 7 Purchasers claims for defects

(1) The statutory regulations shall apply to the Purchasers rights in respect to material and legal defects including incorrect and reduced delivery and incorrect or defective assembly instructions) inasmuch as nothing else has been determined in the following. In all cases the statutory special regulations in case of final delivery of the Goods to a consumer remain unaffected (supplier recourse sections 478 BGB).

(2) The basis of our defect liability is, above all, the agreement made concerning the composition of the Goods. All product descriptions concerning the Goods, which are the subject matter of the individual contract, shall be regarded as agreement concerning the composition of the Goods; there is no difference here whether the product description originates from the Purchaser, from the producer or from us.

(3) Inasmuch as the composition has not yet been agreed, it shall be judged in accordance with statutory regulation whether there is a defect or not (section 434 sub-section 1 sentence 2 and 3 BGB). We do not assume any liability, however, for public statements by the producer or other third parties (e.g. advertising statements).

(4) The claims for defect claims of the Purchaser, who is a businessman, require that he has met his statutory examination and complaint duties without delay. Notice is regarded as without delay if it takes place within seven days in written form with a description of the defect. The same shall apply for defects which are discovered later.

(5) If the item, which has been delivered, is defective, we may first of all choose whether we provide subsequent performance by eliminating the defect (subsequent improvement) or by delivery of an item free of defects (replacement delivery). Our right to refuse subsequent performance under the statutory prerequisites remains unaffected.

(6) We are entitled to make the subsequent performance owed dependent on the Purchaser paying the due purchase price. The Purchaser is, however, entitled to retain a reasonable part of the purchase price in the ratio to the defect.

(7) The Purchaser shall give us the time and opportunity necessary for the subsequent performance owed, in particular to hand over the Goods which are subject to complaint for purposes of testing. In the case of replacement delivery, the Purchaser shall return the defective item in accordance with the statutory regulations. Subsequent performance means neither removal of the defective item nor re-installation if we were not originally obliged to install.

(8) We shall bear the expenditure necessary for examination and subsequent performance, in particular the transport, way, labour and material costs (not: removal and installation costs) if there is in actual fact a defect. If however, the defect elimination demand of the Purchaser turns out to be unjustified, we may demand the costs arising for this from the Purchaser.

(9) In urgent cases, e.g. if operating safety is endangered or to avert disproportionate damage, the Purchaser has the right to eliminate the defect himself and to demand compensation for the objectively necessary expenses for this from

us. We shall be informed about the action taken independently, if possible previously. There is no right to act independently if we would have been entitled to refuse such subsequent performance in accordance with the statutory regulations.

(10) If subsequent performance has failed or a reasonable period to be set for the subsequent performance by the Purchaser has expired without success, or is dispensable in accordance with the statutory regulations, the Purchaser may withdraw from the Purchase Contract or reduce the purchase price. In the case of inappreciable defects, there is however no right of withdrawal.

(11) Any Purchasers claims to damages or compensation for futile expenditure only exist in accordance with the stipulations of section 8 and are otherwise ruled out.

§ 8 Other liability

(1) Inasmuch as nothing else evolves from these General Sales Terms and Conditions including the following provisions, we shall be liable in the case of breach of contractual and non-contractual duties in accordance with the relevant statutory regulations.

(2) We shall be liable for damages – no matter for which legal reason – in the case of intent and gross negligence. In the case of ‚simple‘ negligence, we shall only be liable

a) for damage arising from fatal injury, physical injury or damage to the health

b) for damage arising from the breach of a significant contractual duty (duty the performance of which enables correct execution of the Contract in the first place and on the adherence to which the contract partner may and generally rely); in this case, however, our liability is limited to compensation for the foreseeable, typically arising damage.

(3) The limitations of liability stated in sub-section 2 shall not apply inasmuch as we have maliciously concealed a defect or have assumed warranty for the composition of the Goods. The same shall apply to the Purchasers claims in accordance with the Product Liability Act.

(4) Due to any breach of duty, which does not consist of a defect, the Purchaser may only withdraw (from the Contract) or terminate if we are responsible for the breach of duty. Any free termination right of the Purchaser (in particular in accordance with sections 648,650 BGB) is ruled out. Otherwise the statutory prerequisites and legal consequences shall apply.

§ 9 Re-sale

Active re-sale of our products by the Purchaser in countries outside Germany or active or passive re-sale in the US or Canada requires our previous expressed and written approval. In the

case of such re-sale without our approval, the Purchaser shall indemnify us against any claim in particular for reasons of product liability or patent protection.

§ 10 Purchasers own examination duties

The Purchaser shall check within his own responsibility whether a product purchased by us may be assembled or used in accordance with the traffic and traffic licence provisions applicable in the intended place of use. We shall assume no liability for non-permitted assembly or taking into service unless we have expressly made a corresponding statement about the specific permissibility for the product.

§ 11 Choice of law and place of jurisdiction

(1) The law of the Federal Republic of Germany shall apply for these General Sales Terms and Conditions and all legal relationships between us and the Purchaser excluding international uniform law, in particular the CISG (UN Convention on Contracts for the International Sale of Goods). Prerequisites and the effects of the reservation of title in accordance with section 6 are subject to the law of the place in which the item is stored inasmuch as in accordance with that the choice of law made is impermissible or ineffective in favour of German law.

(2) If the Purchaser is a businessman in the terms of the German Commercial Code, a legal entity under public law or a special fund under public law, the exclusive – also international – place of jurisdiction for all disputes arising from the contractual relationship, either directly or indirectly, shall be our seat of business in Rauschenberg. We are, however, also entitled to take action at the Purchasers general place of jurisdiction of the Purchaser.

§ 12 Dispute resolution procedure

1. It is not our policy, nor are we under any obligation, to participate in any procedure before a consumer dispute resolution body.

2. Advice on out-of-court dispute resolution for consumers ODR platform for Online Dispute Resolution (ODR) of the EU Commission. The new regulation on online dispute resolution is designed to enable consumers and companies to submit conflicts resulting from online purchases to an online dispute-resolution system, viz. using the EU-wide platform for online dispute resolution (the „ODR platform“).

You can reach it via the following URL: <http://ec.europa.eu/odr>

SW-MOTECH Gmbh & Co. KG
Ernteweg 7-10, 35282 Rauschenberg
Amtsgericht Marburg, HRA 4187
USt.ID: DE247 284 853

Personally liable:

BAGS-Connection verwaltungs GmbH
Fichtenweg 19, 35066 Frankenberg
Amtsgericht Marburg, HRB 5067

Represented by:

Jörg Diehl, Kai Jockel, Jürgen Swora,
Achim Kessler

Photography:

CHIRON Group SE, Lennart Andreas Van
Dijk, Erik Peters, Nina Bechtel, Daniel
Keller

Illustrations:

Joachim Jung

Errors and omissions excepted. Technical
and design modifications are subject to
change. SW-MOTECH GmbH & Co. KG
is not liable for content correctness of
printed ads.

IMPORTERS

Algeria	SARL Lion Moto Rider	Algiers	002 1321355033	acedmohamed@lionmoto.com	www.lionmoto.com
Argentina	Motomundo Racing	San Miguel de Tucuman	0054 3814237965	motomundo@motomundo-racing.com	www.motomundo-racing.com
Australia	Motorrad Garage	Eastern Creek	0061 297483006	howard@motorradgarage.com.au	www.motorradgarage.com.au
Belgium	Splash Design B.V.	Veghel	0031 413389089	info@splashdesign.com	www.splashdesign.com
Brazil	Zaken Importação e Exportação Ltda.	Cotia -SP-	0055 1142437348	info@zaken.com.br	www.zaken.com.br
Bulgaria	Motoboom Ltd.	Sofia	0035 929559122	info@motoboom.bg	www.motoboom.bg
Canada	Fullbore Marketing Ltd.	Mississauga	001 9056240222	fullbore@fullboremarketing.ca	www.fullboremarketing.ca
Chile	Comercializadora Motocicleta LTDA Masterbikes	Vitacura, Santiago de Chile	0056 222018154	info@masterbikes.net	www.masterbikes.net
China	Shanghai Youcheng Racing	Shanghai	0086 15515913020	jackcly@gmail.com	HPmoto666.com
China	Shenzhen SM-Technology Limited	Shenzhen	0086 13682490929	richard@sw-motech.com.cn	
Colombia	Inversiones P&G S.A.S.	Bogotá	0057 12586550	info@mososyaccesorios.com	www.motosyaccesorios.com
Costa Rica	MS Motospot Centroamerica S.A.	Heredia, Costa Rica	00503 64279870	director@motospotca.com	www.motospotca.com
Croatia	Novema Nova d.o.o	Karlovac	00385 47715 930	info@novema-nova.hr	www.novema-nova.hr
Cyprus	Motoskopio Ltd.	Nicosia	0035 722317466	motoskopio@cytanet.com.cy	www.motoskopio.net
Czech Repblic	Sumoto spol. s.r.o.	Vojkovice	0042 603747214	sumoto@volny.cz	www.swmotech.cz
Denmark	Nellemann & Drewsen ApS	Aarhus N	0045 87435434	hrh@motostore.dk	www.motostore.dk
El Salvador	Nelson Marroquin	San Salvador	00503 77972725	driftelsalvador@hotmail.com	
Estonia	SanLab OÜ	Tallinn	00372 621 2625	karmo@patareid.ee	www.motokaup.ee
Finland	R.M. Heino Oy Rouhiainen	Tampere	0035 8106170619	myynti@rmheino.fi	www.rmheino.fi
Greece	MotoRAID	Patra	0030 2610437100	info@motoraid.eu	www.motoraid.eu
Guatemala	REVIT Guatemala SA	Guatemala City	00502 66104440	info@revitguatemala.com	
Hong Kong	Freely Motors Trading Co.Ltd.	Hong Kong	00852 27182868	freelymotor@netvigator.com	www.freelymotor.com.hk
Hungary	HPower Motor Kft.	Budapest	0036 304530446	info@hpmotor.hu	www.hpmotor.hu
Iceland	Reykjavik Motor Center EHF.	Reykjavik	0035 45109090	eidur@rmc.is	www.rmc.is
India	Big Bad Bikes	Bangalore	0091 9535688638	info@bigbadbikes.com	www.bigbadbikes.com
Indonesia	PT.ONE3 Jaya	Banten	0062 2122222610	benny.saputra@one3motoshop.com	www.one3motoshop.com
Ireland	Maddocks Online Ltd.	Bray, Co. Wicklow	0035 312868418	info@maddock.ie	www.maddock.ie
Israel	Ofnoit Ltd.	Holon	00972 6833855	ofnoit@netvision.net.il	www.ofnoit.co.il
Italy	Bikerfactory	Arezzo	0039 0575382186	info@bikerfactory.it	www.bikerfactory.com
Japan	Active Co. Ltd.	Aichi	0081 561727011	info@acv.co.jp	www.acv.co.jp
Kuwait	K & S Bike Trading Est.	Shuwaikh	00965 24827822	ktm_q8@hotmail.com	www.knskuwait.com
Latvia	SIA Moto lietas	Riga	0037 127747777	motolietas@motolietas.lv	www.motolietas.lv
Lebanon	Rymco S.A.L.	Beirut	00961 1425512	m.rasamny@rymco.com	www.rymco.com
Lithuania	UAB Motoshop	Vilnius	0037 052720243	mindaugas@motoshop.lt	www.motoshop.lt
Malaysia	The QBEE Motor Group Sdn. Bhd.	Johor Bahru	00607 3560335	an@qbee.com.my	www.qbee.com.my
Malta	M.A. Motorcycles Ltd.	Qormi	0035 621491790	jacqueline@mamotorcycles.com.mt	www.mamotorcycles.com.mt
Mexico	Acc Parts sa de cv	Los Naranjos Leon Guanajuato	0052 4771950941	info@acc-parts.com	www.acc-parts.com
Morocco	Motomania	Casablanca	00212 522361551	otmane.jamil@motomania.ma	www.motomania.ma
Netherlands	Splash Design B.V.	Veghel	0031 413389089	info@splashdesign.com	www.splashdesign.com
New Zealand	454 Unlimited Ltd.	Christchurch	0064 33662144	sales@454.co.nz	www.454.co.nz

Norway	Alf Graarud Motor AS	Borgenhaugen	0047 69137171	lene@alf-graarud-motor.no	www.agmshop.no
Peru	Bigtrail Peru	Lima	00511 6765338	renzog@bigtrailperu.com	
Philippines	Riders Hub Revolution Corp.	Pasay City	0063 9173096276	sales@bigbiketech.com	www.bigbiketech.com
Poland	Powerbike S.A.	Dopiewo	0048 616535750	info@powerbike.pl	www.powerbike.pl
Portugal	BalGarPir Equipamento para Motociclismo Lda.	Mem Martins - Sintra	00351 219173438	sales@balgarpir.com	www.balgarpir.com
Romania	S.C. Moto Mus Design S.R.L.	Cluj Mun. Gherla	0040 740178171	contact@motomus.ro	www.motomus.ro
Russia	Motorization Ltd.	Moscow	007 9859914137	dl@wroom.ru	www.wroom.ru
Serbia	Burnout d.o.o.	Novi Beograd	0038 1693393801	sales@burnout.rs	www.ducati.rs
Slovakia	Sumoto spol. s.r.o.	Vojkovice	0042 545211913	sumoto@centrum.cz	www.sumotobrno.cz
Slovenia	Aures d.o.o. Koper	Koper	00386 56306550	info@aires.si	www.aires.si
South Africa	Zipski Twenty Three	Port Elizabeth	0027 414662553	info@bikegear.co.za	www.bikegear.co.za
South Korea	Harry Tongsang Inc.	Gyeonggi	0082 24765690	harryinckor@gmail.com	www.biketech.co.kr
Sweden	CB-Parts Import Distribution & Trading AB	Uppsala	0046 851173120	kundsupport@cbparts.se	www.adventuremc.se
Switzerland	Hostettler AG	Sursee	0041 419266106	info@motochic.ch	www.hostettler.com
Taiwan	Promotec International Co.Ltd.	Taipei	00886 225987770	pro.motec@msa.hinet.net	www.promotec.com.tw
Thailand	Panda Rider Ltd.	Bangkok	0066 29729385	motul@pandarider.com	www.pandarider.com
Turkey	Tümoparsan Motor Sanayi Ve Tic. Ltd. STI	Istanbul	0090 2126689700	sw-motech@motoplus.com.tr	www.motoplus.com.tr
Ukraine	ProMoto	Kiew	0038 0639721796	admin@promoto.ua	www.promoto.ua
United Arab Emirates	Oldtimer Motorcycles & Spare Parts Trading LLC	Dubai	00971 564804689	info@oldtimer-me.com	www.oldtimer-me.com
United Kingdom	Motohaus Powersports Ltd.	Hook	0044 1256704909	info@motohaus.com	www.motohaus.com
USA	Twisted Throttle LLC.	Exeter, RI	001 4012844200	info@twistedthrottle.com	www.twistedthrottle.com/sw-motech
Vietnam	TT-Motocycle	Ho Chi Minh City	0084 902756545	tungnguyen@tt-moto.vn	www.tt-moto.vn







SW-MOTECH GmbH & Co. KG
Ernteweg 7 – 10 | 35282 Rauschenberg | Germany
+49 6425 8168-050 | export@sw-motech.com
www.sw-motech.com/en