

2021

Puig
Hi-Tech Parts



OUR PASSION FROM WITHIN.

2020 will be remembered as an unusual year as a result of COVID-19. The dramatic health situation that our country has experienced made our company available to the health authorities from the first moment and we allocated a part of our production to the manufacture of protection material in PMMA, which is the material we use to manufacture our windshields and screens, selflessly. We hope that the elements manufactured by Puig have been useful in saving human lives.

Although the season of the **MOTO GP** and **SUPERBIKES** championships has delayed its start, during the lockdown we have not stopped technically collaborating with the HRC (MOTO GP) and KRT (SUPERBIKES) teams, testing new materials, shapes and designs that have already been applied to the products in this new catalog. From here, we support both teams with all of our technology to give us a new world crown to add to our list of honors in 2020.

In this new catalog we have been forced, due to volume, reliability and updating issues to restrict the number of application tables, and to support their consultation through our website.

Here are some highlights for the 2021 news that you can find in the catalog:

- Extension of the range of **Downforce Spoilers** for Naked and Hyper sport motorcycles (pages 113-115).
- **Handlebar area:** Shark model universal windshield (page 124), brake-clutch lever protector (page 183), scooters levers (page 191), rearview mirrors mod. Look (page 229) and GT.1 (page 247), Original rearview covers (page 257), Mobile phone supports (page 279).
- **Middle front zone:** Tower sequential turn signal (page 347) and extension of our offer of wiring extension for turn signals (page 366) and license plate lights (page 380).
- **Chassis-Engine area:** Vintage 2.0 model frame slider (page 443), Carter oil cap (page 421).
- **Wheels area:** Single-sided rear fenders (page 483).
- **Merchandising:** New displays of 3.0 levers and visors (page 532), clothing and accessories.

One more year we appreciate the trust you place in the brand, which encourages us to continue pushing to keep this catalog up to date, year after year and hoping we win the battle against COVID-19 shortly, together. Stay healthy.

Puig
Hi-Tech Parts



The CORONAVIRUS has changed our day to day, the way we relate, buy and share workspace. The new normality brings with it a series of norms of social distancing and hygiene to avoid the spread and a possible regrowth. Business will not be the same for now. All of them must ensure the safety of their clients and workers. Extra work that Puig aims to make easier with our range of Covid-19 products.

Check www.puig.tv typing in the searching window



DESKTOP PROTECTIVE SCREENS



OFFICE SCREEN

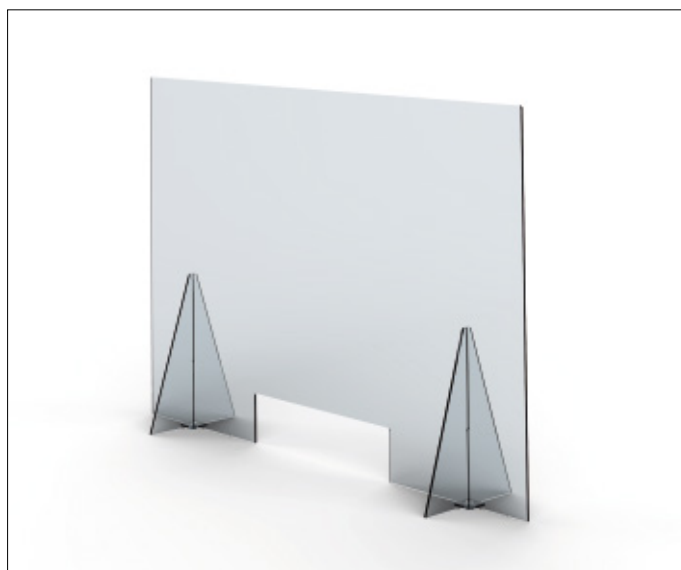

DESKTOP-DISPLAY SCREEN WITH WINDOW

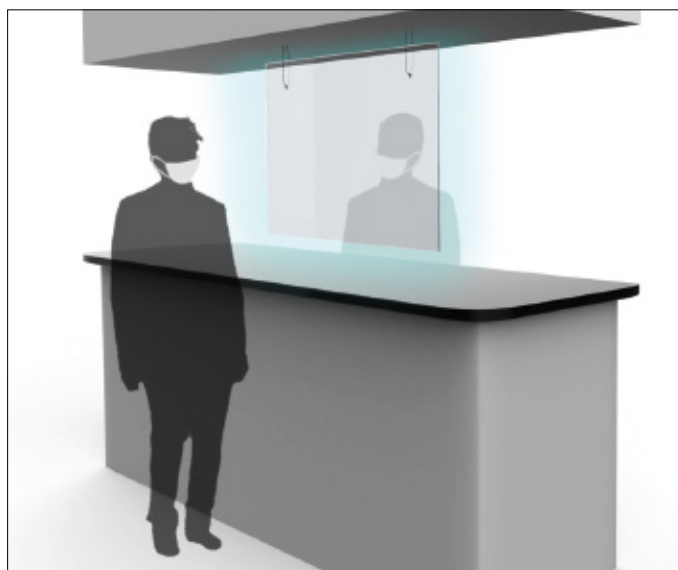

WALL-MOUNTED CEILING SCREEN



METHACRYLATE BOX



STICKERS KIT 'SAFETY DISTANCE'

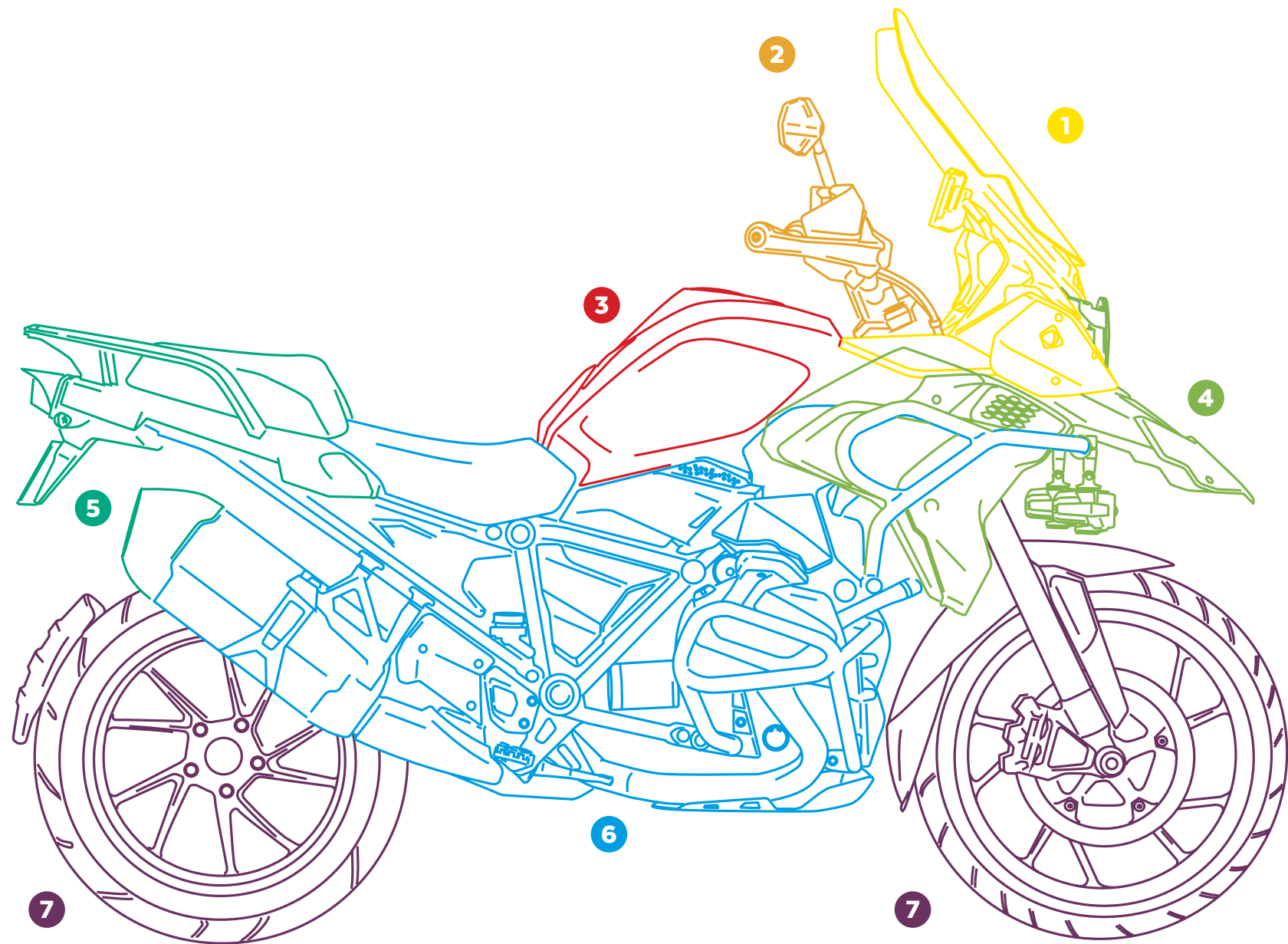

FULLY EQUIPPED MOTORCYCLES
P. 8

RACING
P. 22

1. SUPERIOR FRONT AREA
P. 28

2. SUPERIOR FRONT AREA
P. 160

3. GAS TANK AREA
P. 282

4. MIDDLE FRONT AREA
P. 324

5. REAR AREA
P. 370

6. CHASSIS-ENGINE AREA
P. 390

7. WHEELS AREA
P. 468

MAINTENANCE / WORKSHOP
P. 518

TOP BOXES
P. 526

WINTER
P. 530

MERCHANDISING
P. 532

HONDA CRF1100L AFRICA TWIN

1	TOURING SCREEN	33
2	BEAK EXTENDER	327
3	INFILL PANELS	461
4	PHB19 FRONT FORK PROTECTOR	497
5	PHB19 SWING ARM PROTECTOR	497
6	LICENSE PLATE HOLDER	373
7	ENDURO FOOTPEGS	397
8	SPORT FOOTPEGS	395
9	REARVIEW MIRROR GT.1	247
10	SMARTPHONE CASE	275



KAWASAKI NINJA 1000 SX

1	RACING SCREEN	31
2	PRO FRAME SLIDERS	437
3	PHB19 FRONT FORK PROTECTOR	497
4	LICENSE PLATE HOLDER	373
5	LEVERS 3.0	167
6	R-FIGHTER S FOOTPEGS	393
7	SPORT FOOTPEGS	395
8	BAR ENDS THRUSTER	223
9	REARVIEW MIRROR GT.1	247
10	BRAKE LIQUID TANK COVER	202
11	SPOOL SLIDER PRO	423
12	TRACK OIL PLUGS	421



KAWASAKI Z650

1	WINDSHIELD NEW GENERATION SPORT	105
2	ENGINE SPOILERS	431
3	DOWNFORCE SPOILERS NAKED	117
4	R19 FRAME SLIDERS	439
5	PHB19 FRONT FORK PROTECTOR	497
6	LICENSE PLATE HOLDER	373
7	LEVERS 3.0	167
8	R-FIGHTER FOOTPEGS	393
9	HI-TECH ASCENT GRIPS	215
10	BAR ENDS THRUSTER	223
11	REARVIEW MIRROR F1.1	251
12	SMARTPHONE CASE	275
13	BRAKE LIQUID TANK COVER	202
14	SPOOL SLIDER PRO	423
15	TRACK OIL PLUGS	421



KAWASAKI Z900

1	WINDSHIELD NEW GENERATION SPORT	105
2	ENGINE SPOILERS	431
3	DOWNFORCE SPOILERS NAKED	117
4	PHB19 FRONT FORK PROTECTOR	497
5	LICENSE PLATE HOLDER	373
6	LEVERS 3.0	167
7	RACING FOOTPEGS	395
8	HI-TECH ASCENT GRIPS	215
9	SHORT BAR ENDS	225
10	REARVIEW HYPERNAKED	243
11	BRAKE LIQUID TANK COVER	202
12	SPOOL SLIDER PRO	423
13	TRACK OIL PLUGS	421



YAMAHA TENERE 700

1	TOURING SCREEN	33
2	HANDGUARDS EXTENSION	263
3	REAR FENDER	471
4	BEAK EXTENDER	327
5	HEADLIGHT PROTECTOR	337
6	PHB19 FRONT FORK PROTECTOR	497
7	PHB19 SWING ARM PROTECTOR	497
8	LICENSE PLATE HOLDER	373
9	ENGINE GUARDS	455
10	ENDURO FOOTPEGS	397
11	SPORT FOOTPEGS	395
12	REARVIEW MIRROR EXPLORER	245
13	SMARTPHONE CASE	275



YAMAHA T-MAX 560

1	WINDSHIELD V-TECH LINE SUPERSPORT	79
2	PHB19 FRONT FORK PROTECTOR	497
3	PHB19 SWING ARM PROTECTOR	497
4	LICENSE PLATE HOLDER	373
5	LEVERS 3.0	167
6	SPORT FOOTPEGS	395
7	BAR ENDS THRUSTER	223
8	REARVIEW MIRROR F1.1	251
9	PARKING BRAKE LEVER	211
10	CLUTCH COVER	459
11	PAIR TENSORS FOR REAR WHEEL	499



HONDA CMX 500 REBEL

1	ALUMINIUM FRONTAL PLATE	95
2	FRONT FENDER	487
3	LICENSE PLATE HOLDER	373
4	ENGINE GUARDS	455
5	HERITAGE LEVERS	193
6	HERITAGE FOOTPEGS	399
7	REARVIEW MIRROR RETRO	241
8	TRACK OIL PLUGS	421



Puig
Hi-Tech Parts

#6

STEFAN BRADL
HONDA REPSOL TEAM MOTOGP 2020



#93

MARC MÁRQUEZ
HONDA REPSOL TEAM MOTOGP 2020

#73

ALEX MÁRQUEZ
HONDA REPSOL TEAM MOTOGP 2020

Puig
Hi-Tech Parts



#22

ALEX LOWES
KAWASAKI RACING TEAM WORLDSBK 2020



#1

JONATHAN REA
KAWASAKI RACING TEAM WORLDSBK 2020



#11

ANA CARRASCO
PROVEC KAWASAKI TEAM WORLDSUP300 2020



Puig
Hi-Tech Parts

#24

SIMONE CORSI
FORWARD RACING TEAM MOTO2 2020

#62

STEFANO MANZI
FORWARD RACING TEAM MOTO2 2020

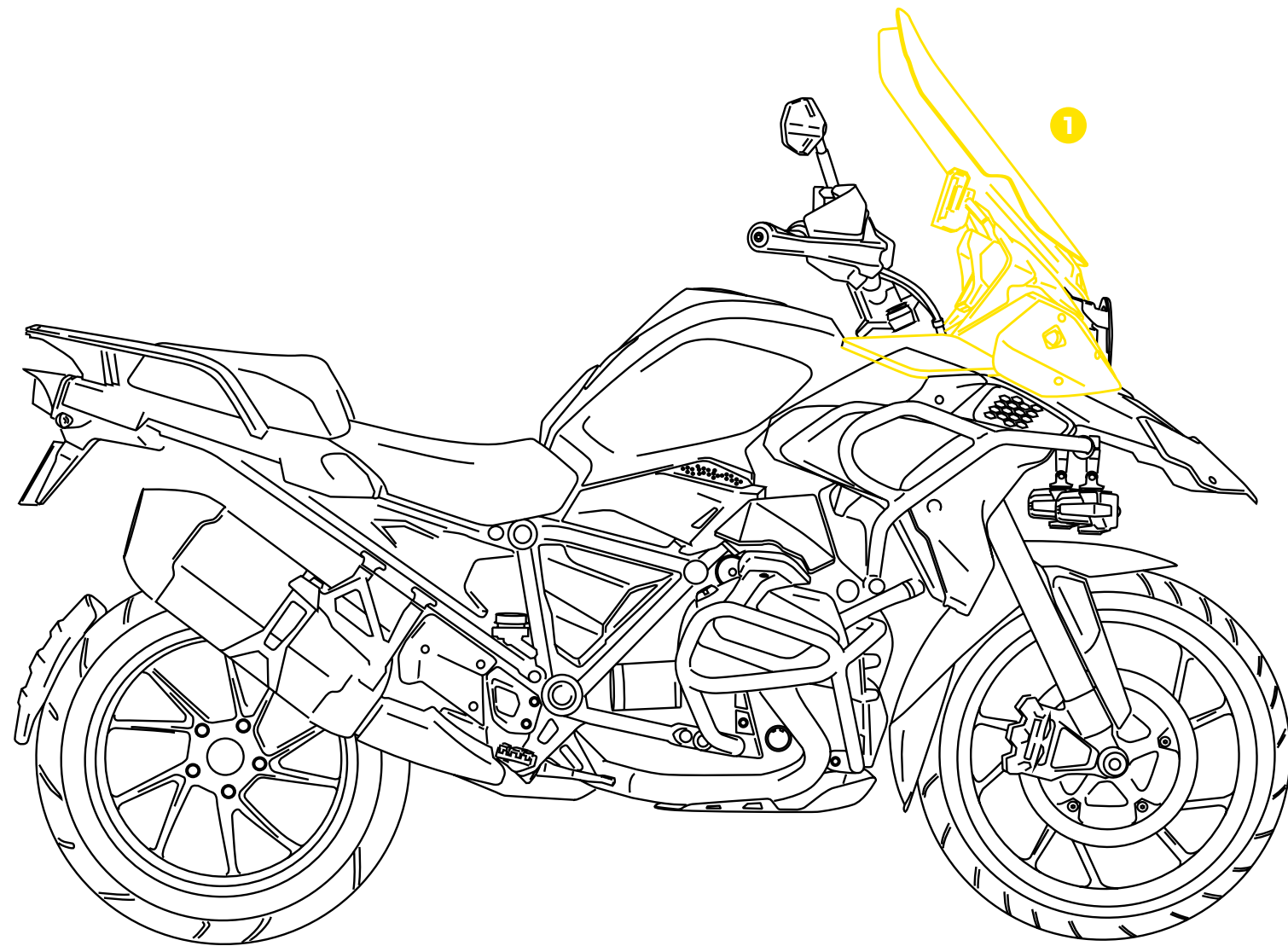

SUPERIOR FRONT AREA

AMERICA I WINDSHIELD	150
AMERICA II WINDSHIELD	151
AMERICA III WINDSHIELD	152
BAT WINDSHIELD	125
CHOPPER WINDSHIELD	146
CITY SPORT WINDSHIELD	153
CITY TOURING WINDSHIELD	154
CLOCK TOPS	120
COCKPIT WINDSHIELD	133
CUSTOM I WINDSHIELD	140
CUSTOM II WINDSHIELD	141
CUSTOM II WITH VISOR WINDSHIELD	142
DAYTONA III WINDSHIELD	149
DAYTONA IV WINDSHIELD	148
DEFLECTORS FOR WINDSHIELDS	89
DOWNFORCE SPOILERS NAKED	117
DOWNFORCE SPOILERS RACE	115
DOWNFORCE SPOILERS SPORT	113
E.R.S.	77
FRONTAL DEFLECTOR SCREENS	121
FRONTAL PLATE (IN ABS)	97
FRONTAL PLATE (IN ALUMINIUM)	95
HAND GUARDS	159
HIGHWAY WINDSHIELD	147
M.E.M.	75
MULTIADJUSTABLE VISORS CLIP-ON	87
MULTIADJUSTABLE VISORS FIXED BY SCREWS	85
NAKED WINDSHIELD	131
NUMBERS	103

PLUS WINDSHIELD	139
RAFALE WINDSHIELD	126
RANGER WINDSHIELD	143
RAPTOR WINDSHIELD	132
RETROVISIONS	93
ROADSTER WINDSHIELD	145
SCREWS	72
SEMI-FAIRINGS	91
SHARK WINDSHIELD	124
T.S. WINDSHIELD	157
T.X. WINDSHIELD	158
TOP WINDSHIELD	138
TOURING I WINDSHIELD	144
TOURING II WINDSHIELD	130
TRACK WINDSHIELD	135
TRAFIC WINDSHIELD	155
TREND WINDSHIELD	128
TREND WITH VISOR WINDSHIELD	129
UP&DOWN WINDSHIELD	127
UPPER DEFLECTORS	123
URBAN WINDSHIELD	156
VISION WINDSHIELD	137
WAVE WINDSHIELD	134
WINDSCREEN MODELS	33
WINDSCREENS FOR FAIRING BIKES	31
WINDSHIELD SPECIFIC FOR NON-ROUND HEADLIGHTS	105
WINDSHIELDS FOR MAXISCOOTERS	79
WINDY WINDSHIELD	136

WINDSCREENS FOR FAIRING BIKES

HI-TECH PARTS | TECHNICAL SECTION



// SCREEN TESTED IN THE VIRTUAL WIND TUNNEL

Improved aerodynamics and wind protection on average 12,7% compared with OEM screen.

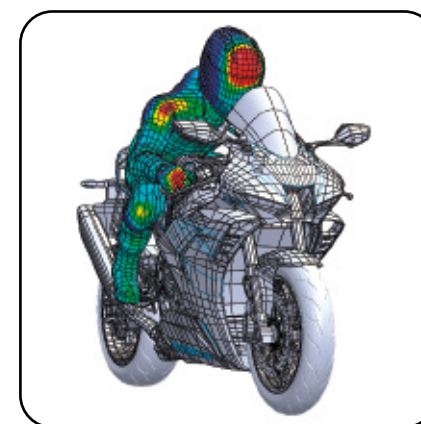

● Lower pressure
● Max. pressure
Wind pressure with a PUIG screen.

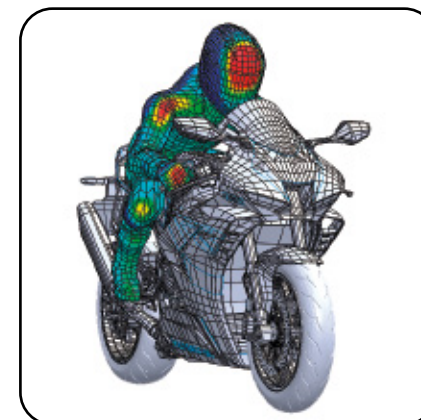

● Lower pressure
● Max. pressure
Wind pressure with a OEM screen.

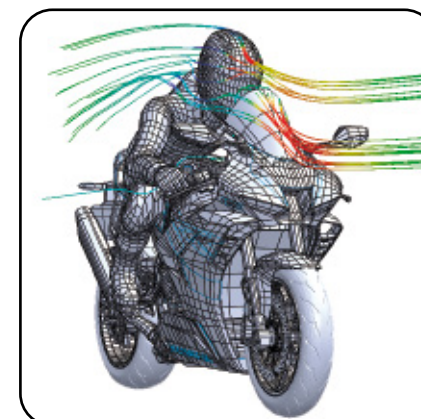

Improved aerodynamics and wind protection on average +12,7%

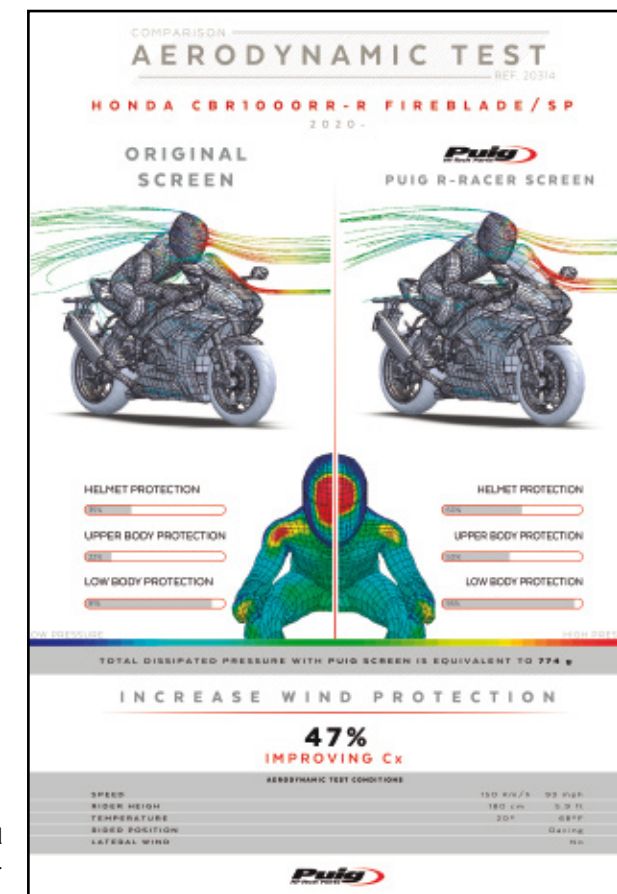

Aerodynamic test delivered with almost all our screens. Check our website.



3 mm. high impact acrylic.
Resistant - Durable.
Precise fit.

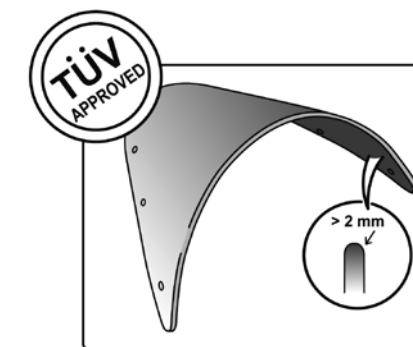

Rounded edge screen profile in >2 mm. Complying with the German TÜV regulations.

FOR SPECIFIC MODELS SEE PAGE 34.

WINDSCREEN MODELS

HI-TECH PARTS | TYPE OF WINDSCREEN:

NEW! 



RACING

Doble height Windscren, it drives the air away from your helmet, for supersport bikes.



TOURING

Windscreen taller than the original to provide more protection to the rider.



NEW GENERATION

Windscreen with adaptor specifically designed for motorcycles that do not have a screen, especially for Naked models.



STANDARD

Windscreen without supports, form and height are the same as the original windscreen.



Z-RACING

Windscreen with edges in Z form that drives the air away from the helmet. Slightly taller than the original. Wide range of colors.



TOURING PLUS

Windscreen larger than the Puig Touring model, for certain models of motorcycle tourer for maximum aerodynamic protection.



TOURING WITH VISOR "CLIP ON"

Higher windscreen than the original to which is assigned a multi-adjustable visor that is fixed with a system called "clip-on" to divert the air from the rider and provide maximum comfort when driving.



SPORT

Windscreen without supports, lower than the original windscreen.



R-RACER

Windscreen that comes from competition, without edges. Significantly taller than the original one. Available in smoked colors.



TOURING WITH VISOR

Higher windscreen than the original that incorporates a multi-adjustable screwed visor to divert air from the rider and provide comfort.



ADJUSTABLE

Windscreen that can be adjusted in height, with or without tools and adjust it to the most suitable position for each rider / situation.

WINDSCREEN MODELS

HI-TECH PARTS | TYPE OF WINDSCREEN:

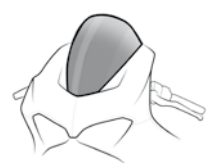

STANDARD

Windscreen without supports, form and height are the same as the original windscreen.



SPORT

Windscreen without supports, lower than the original windscreen.



RACING

Doble height Windscen, it drives the air away from your helmet, for supersport bikes.

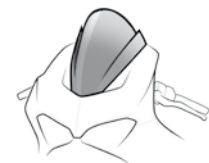

Z-RACING

Windscreen with edges in Z form that drives the air away from the helmet. Slightly taller than the original. Wide range of colors.



R-RACER

Windscreen that comes from competition, without edges. Significantly taller than the original one. Available in smoked colors.



NEW GENERATION

Windscreen with adaptor specifically designed for motorcycles that do not have a screen, especially for Naked models.



TOURING

Windscreen taller than the original to provide more protection to the rider.



TOURING PLUS

Windscreen larger than the Puig Touring model, for certain models of motorcycle tourer for maximum aerodynamic protection.



TOURING WITH VISOR

Higher windscreen than the original that incorporates a multi-adjustable screwed visor to divert air from the rider and provide comfort.



TOURING WITH VISOR "CLIP ON"

Higher windscreen than the original to which is assigned a multi-adjustable visor that is fixed with a system called "clip-on" to divert the air from the rider and provide maximum comfort when driving.



ADJUSTABLE

Windscreen that can be adjusted in height, with or without tools and adjust it to the most suitable position for each rider / situation..

2021 MODELS: www.puig.tv

MODEL	YEAR	TYPE OF WINDSCREEN	REF.	DIMENSIONS (Height x Width)	HEIGHT (mm) Compared to OEM	THICKNESS (mm)	N H	W F	R V	T A	G C
APRILIA											
CAPONORD 1200	13' - 16'	TOURING	6484	590 x 440	+150	4	(*)	(*)			
CAPONORD 1200	13' - 16'	TOURING SCREEN WITH VISOR BOLT-ON	6502H				(*)				
CAPONORD 1200	13' - 16'	TOURING SCREEN WITH CLIP-ON VISOR	6484 + 6320				(*)	(*)			
CAPONORD 1200 RALLY	15' - 16'	TOURING	6484	590 x 440	+150	4	(*)	(*)			
CAPONORD 1200 RALLY	15' - 16'	TOURING SCREEN WITH VISOR BOLT-ON	6502H				(*)				
CAPONORD 1200 RALLY	15' - 16'	TOURING SCREEN WITH CLIP-ON VISOR	6484 + 6320				(*)	(*)			
DORSODURO 750	08' - 16'	NEW GENERATION	SEE PAGE 106								
DORSODURO 900	17' - 20'	NEW GENERATION	SEE PAGE 106								
DORSODURO 1200	11' - 16'	NEW GENERATION	SEE PAGE 106								
PEGASO STRADA 650	05' - 10'	TOURING	2165	410 x 350	+40	3	(*)	(*)			
PEGASO TRAIL 650	06' - 09'	TOURING	2165	410 x 350	+40	3	(*)	(*)			
RS 50/ RS 125/ RS 250	99' - 05'	RACING	1091	320 x 380		3	(*)	(*)			
RS 50/ RS 125	06' - 10'	RACING	4183	400 x 300		3	(*)	(*)			
RS4 50/RS4 125	11' - 18'	Z-RACING	4945	365 x 270		3	(*)				
RSV4	09' - 12'	Z-RACING	4945	365 x 270		3	(*)				
RSV4 FACTORY	13' - 14'	Z-RACING	4945	365 x 270		3	(*)				
RSV4 R	13' - 14'	Z-RACING	4945	365 x 270		3	(*)				
RSV4 RF/RR	15' - 20'	Z-RACING	7614	390 x 250	+30	3	(*)	(*)			
SHIVER 750	07' - 09'	NEW GENERATION	SEE PAGE 106								
SHIVER 750	10' - 16'	Z-RACING	5249	350 x 330	+180	3	(*)				
SHIVER 900	17' - 20'	NEW GENERATION	SEE PAGE 106								
TUONO 125	17' - 20'	Z-RACING	7615	320 x 270	+30	3	(*)				
TUONO 1000R	06' - 10'	Z-RACING	4110	400 x 270		3	(*)	(*)			
TUONO V4R	11' - 14'	Z-RACING	5647	375 x 300	+185	3	(*)	(*)			
TUONO V4 1100 RR	15' - 20'	Z-RACING	7615	320 x 270	+30	3	(*)				
TUONO V4 1100 FACTORY	15' - 20'	Z-RACING	7615	320 x 270	+30	3	(*)				

2021 MODELS: www.puig.tv

MODEL	YEAR	TYPE OF WINDSCREEN	REF.	DIMENSIONS (Height x Width)	HEIGHT (mm) Compared to OEM	THICKNESS (mm)	N H	W F	R V	T A	G C
BENELLI											
502C	19' - 20'	NEW GENERATION	SEE PAGE 106								
LEONCINO 500	16' - 20'	NEW GENERATION	SEE PAGE 106								
LEONCINO TRAIL	17' - 20'	NEW GENERATION	SEE PAGE 106								
TORNADO 302R	14' - 20'	TOURING	9591	373 x 340	+40	3	(*)	(*)			
TRK 502	16' - 20'	TOURING	9485	555 x 385	+110	4	(*)				
TRK 502	16' - 20'	TOURING SCREEN WITH VISOR BOLT-ON	9508H				(*)				
TRK 502	16' - 20'	TOURING SCREEN WITH CLIP-ON VISOR	9485 + 6375				(*)				
TRK 502 X	16' - 20'	TOURING	9485	555 x 385	+110	4	(*)				
TRK 502 X	16' - 20'	TOURING SCREEN WITH VISOR BOLT-ON	9508H				(*)				
TRK 502 X	16' - 20'	TOURING SCREEN WITH CLIP-ON VISOR	9485 + 6375				(*)				
BMW											
F650GS	04' - 07'	TOURING	2015	440 x 305	+30	4	(*)	(*)			
F650GS	08' - 12'	TOURING	4670	300 x 200	+120	3	(*)	(*)			
F650GS	08' - 12'	TOURING SCREEN WITH VISOR BOLT-ON	5914H				(*)				
F650GS	08' - 12'	TOURING SCREEN WITH CLIP-ON VISOR	4670 + 6320				(*)				
F650ST	93' - 00'	TOURING	0307	500 x 410	+70	3	(*)	(*)			
F700GS	12' - 17'	TOURING	6365	490 x 400	+220	3	(*)	(*)			
F750GS	18' - 20'	TOURING	3768	410 x 365	+183	4	(*)				
F750GS	18' - 20'	TOURING SCREEN WITH VISOR BOLT-ON	3832H				(*)				

ANODIZED ALUMINIUM SCREWS AVAILABLE SEE PAGE 72.

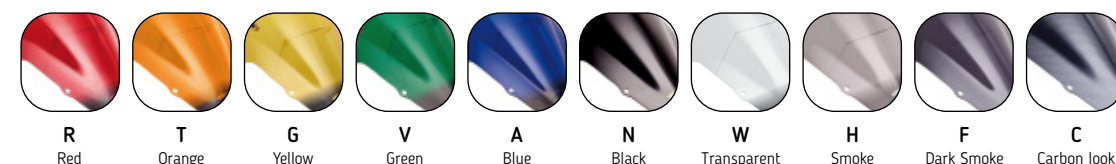

CARBON LOOK: RACING SCREEN AVAILABLE ONLY.
NOTE COLORS: N COLOR DELIVERED WITHOUT SILK PRINT.
 (*) Check price with your distributor.
 (-) Adjustable in width and height.
IMPORTANT: Indicate code color after part#. Example 0973A

WINDSCREEN MODELS

HI-TECH PARTS | TYPE OF WINDSCREEN:

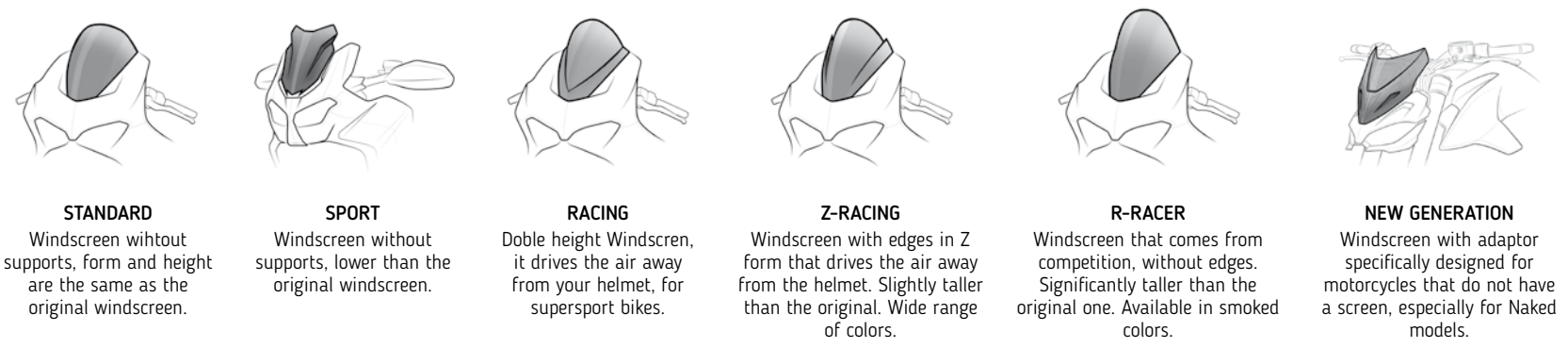

STANDARD
Windscreen without supports, form and height are the same as the original windscreen.

SPORT
Windscreen without supports, lower than the original windscreen.

RACING
Doble height Windscreen, it drives the air away from your helmet, for supersport bikes.

Z-RACING
Windscreen with edges in Z form that drives the air away from the helmet. Slightly taller than the original. Wide range of colors.

R-RACER
Windscreen that comes from competition, without edges. Significantly taller than the original one. Available in smoked colors.

NEW GENERATION
Windscreen with adaptor specifically designed for motorcycles that do not have a screen, especially for Naked models.

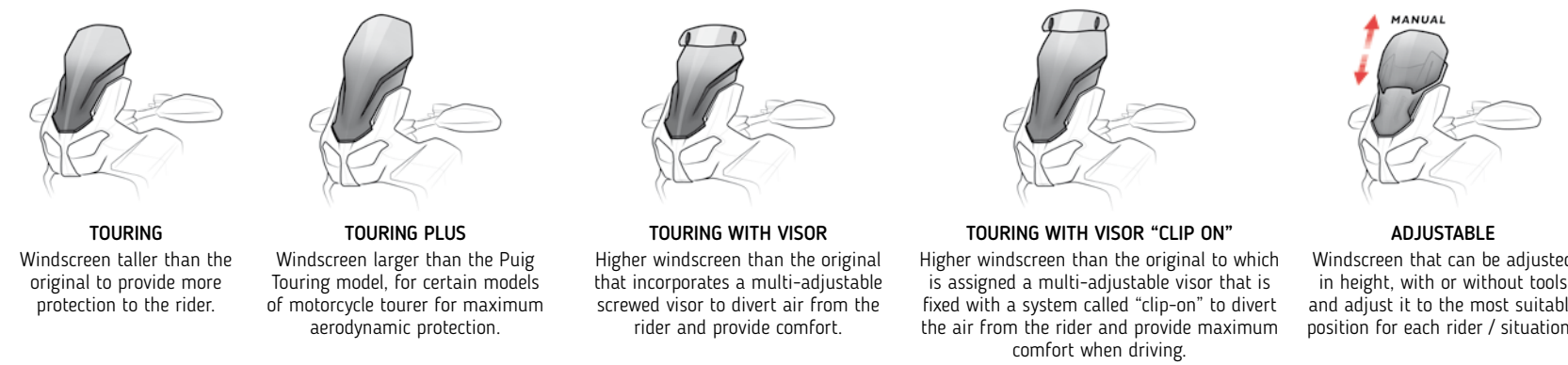

TOURING
Windscreen taller than the original to provide more protection to the rider.

TOURING PLUS
Windscreen larger than the Puig Touring model, for certain models of motorcycle tourer for maximum aerodynamic protection.

TOURING WITH VISOR
Higher windscreen than the original that incorporates a multi-adjustable screwed visor to divert air from the rider and provide comfort.

TOURING WITH VISOR "CLIP ON"
Higher windscreen than the original to which is assigned a multi-adjustable visor that is fixed with a system called "clip-on" to divert the air from the rider and provide maximum comfort when driving.

ADJUSTABLE
Windscreen that can be adjusted in height, with or without tools and adjust it to the most suitable position for each rider / situation..

2021 MODELS: www.puig.tv

MODEL	YEAR	TYPE OF WINDSCREEN	REF.	DIMENSIONS (Height x Width)	HEIGHT (mm) Compared to OEM	THICKNESS (mm)	N W H F	R T G V A C
F750GS	18' - 20'	TOURING SCREEN WITH CLIP-ON VISOR	3768 + 6319				(*)	
F750GS	18' - 20'	TOURING PLUS	9770	540 x 415	+295	4	(*)	
F750GS	18' - 20'	TOURING PLUS SCREEN WITH VISOR BOLT-ON	9771H				(*)	
F750GS	18' - 20'	TOURING PLUS SCREEN WITH CLIP-ON VISOR	9770 + 6320				(*)	
F750GS	18' - 20'	ADJUSTABLE	3178	490 x 420	+325	4	(*)	
F800GT	13' - 20'	TOURING	6485	610 x 370	+140	3	(*)	(*)
F800GT	13' - 20'	TOURING SCREEN WITH VISOR BOLT-ON	6503H				(*)	
F800GT	13' - 20'	TOURING SCREEN WITH CLIP-ON VISOR	6485 + 6375				(*)	(*)
F800GS	08' - 17'	TOURING	4670	300 x 200	+120	3	(*)	(*)
F800GS	08' - 17'	TOURING SCREEN WITH VISOR BOLT-ON	5914H				(*)	
F800GS	08' - 17'	TOURING SCREEN WITH CLIP-ON VISOR	4670 + 6320				(*)	(*)
F800GS ADVENTURE	13' - 18'	ADJUSTABLE	7307	380 x 345	+155	4	(*)	
F800R	09' - 20'	NEW GENERATION	SEE PAGE 106					
F800S	06' - 11'	TOURING	4376	390 x 330		3	(*)	
F800ST	06' - 13'	TOURING	4376	390 x 330		3	(*)	
F850GS	18' - 20'	TOURING	3769	410 x 365	+90	4	(*)	
F850GS	18' - 20'	TOURING SCREEN WITH VISOR BOLT-ON	3831H				(*)	
F850GS	18' - 20'	TOURING SCREEN WITH CLIP-ON VISOR	3769 + 6319				(*)	
F850GS	18' - 20'	TOURING PLUS	3595	540 x 415	+220	4	(*)	
F850GS	18' - 20'	TOURING PLUS SCREEN WITH VISOR BOLT-ON	3597H				(*)	
F850GS	18' - 20'	TOURING PLUS SCREEN WITH CLIP-ON VISOR	3595 + 6320				(*)	
F850GS	18' - 20'	ADJUSTABLE	3179	490 x 420	+255	4	(*)	
F850GS ADVENTURE	19' - 20'	TOURING	3769	410 x 365	+90	4	(*)	

2021 MODELS: www.puig.tv

MODEL	YEAR	TYPE OF WINDSCREEN	REF.	DIMENSIONS (Height x Width)	HEIGHT (mm) Compared to OEM	THICKNESS (mm)	N W H F	R T G V A C
F850GS ADVENTURE	19' - 20'	TOURING SCREEN WITH VISOR BOLT-ON	3831H				(*)	
F850GS ADVENTURE	19' - 20'	TOURING SCREEN WITH CLIP-ON VISOR	3769 + 6319				(*)	
F850GS ADVENTURE	19' - 20'	ADJUSTABLE	3179	490 x 420	+255	4	(*)	
F850GS ADVENTURE	19' - 20'	TOURING PLUS	3595	530 x 415	+220	4	(*)	
F850GS ADVENTURE	19' - 20'	TOURING SCREEN WITH VISOR BOLT-ON	3597H				(*)	
F850GS ADVENTURE	19' - 20'	TOURING SCREEN WITH CLIP-ON VISOR	3595 + 6320				(*)	
F900XR	20'	SPORT	20429	378 x 335	-80	4	(*)	
F900XR	20'	TOURING	20391	565 x 360	+125	4	(*)	
F900XR	20'	TOURING SCREEN WITH VISOR BOLT-ON	20392H				(*)	
F900XR	20'	TOURING SCREEN WITH CLIP-ON VISOR	20391 + 6320				(*)	
G310GS	17' - 20'	TOURING	9879	430 x 340	+180	3	(*)	
G310GS	17' - 20'	TOURING SCREEN WITH VISOR BOLT-ON	9880H				(*)	
G310GS	17' - 20'	TOURING SCREEN WITH CLIP-ON VISOR	9879 + 6320				(*)	
G310R	16' - 20'	NEW GENERATION	SEE PAGE 106					
G650GS	10'	TOURING	2015	440 x 305	+30	4	(*)	(*)
G650GS	11' - 16'	TOURING	5649(-)	420 x 450	+205	3	(*)	
G650GS	11' - 16'	TOURING SCREEN WITH VISOR BOLT-ON	5915H (-)				(*)	
G650GS	11' - 16'	TOURING SCREEN WITH CLIP-ON VISOR	5649 + 6319				(*)	
K1200R SPORT	07' - 08'	TOURING	4669	360 x 450		3	(*)	(*)

ANODIZED ALUMINIUM SCREWS AVAILABLE SEE PAGE 72.

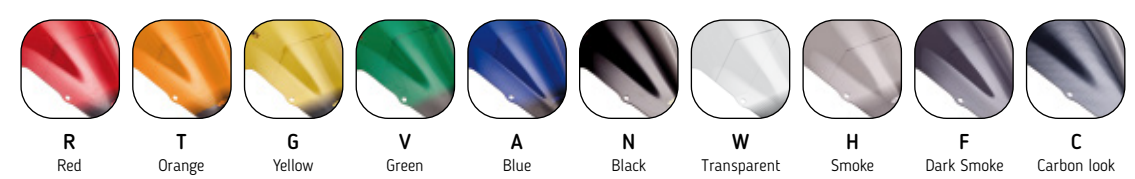

CARBON LOOK: RACING SCREEN AVAILABLE ONLY.
NOTE COLORS: N COLOR DELIVERED WITHOUT SILK PRINT.
 (*) Check price with your distributor.
 (-) Adjustable in width and height.
IMPORTANT: Indicate code color after part#. Example 0973A

WINDSCREEN MODELS

HI-TECH PARTS | TYPE OF WINDSCREEN:



STANDARD

Windscreen without supports, form and height are the same as the original windscreen.



SPORT

Windscreen without supports, lower than the original windscreen.



RACING

Doble height Windscren, it drives the air away from your helmet, for supersport bikes.

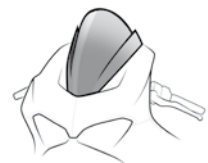

Z-RACING

Windscreen with edges in Z form that drives the air away from the helmet. Slightly taller than the original. Wide range of colors.



R-RACER

Windscreen that comes from competition, without edges. Significantly taller than the original one. Available in smoked colors.

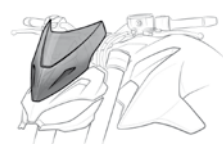

NEW GENERATION

Windscreen with adaptor specifically designed for motorcycles that do not have a screen, especially for Naked models.



TOURING

Windscreen taller than the original to provide more protection to the rider.



TOURING PLUS

Windscreen larger than the Puig Touring model, for certain models of motorcycle tourer for maximum aerodynamic protection.



TOURING WITH VISOR

Higher windscreen than the original that incorporates a multi-adjustable screwed visor to divert air from the rider and provide comfort.



TOURING WITH VISOR "CLIP ON"

Higher windscreen than the original to which is assigned a multi-adjustable visor that is fixed with a system called "clip-on" to divert the air from the rider and provide maximum comfort when driving.



ADJUSTABLE

Windscreen that can be adjusted in height, with or without tools and adjust it to the most suitable position for each rider / situation..

2021 MODELS: www.puig.tv

MODEL	YEAR	TYPE OF WINDSCREEN	REF.	DIMENSIONS (Height x Width)	HEIGHT (mm) Compared to OEM	THICKNESS (mm)	N H	W F	R V	T A	G C
K1200S	04' - 08'	TOURING	2207	430 x 430		3	(*)	(*)			
K1300R	09' - 16'	NEW GENERATION	SEE PAGE 106								
K1300S	09' - 16'	TOURING	2207	430 x 430		3	(*)	(*)			
K1600 GT	11' - 20'	TOURING	9512	695 x 680	+105	4	(*)				
K1600 GT	11' - 20'	TOURING SCREEN WITH VISOR BOLT-ON	9513H				(*)				
K1600 GT	11' - 20'	TOURING SCREEN WITH CLIP-ON VISOR	9512 + 6375				(*)				
K1600 GTL	11' - 20'	TOURING	9512	695 x 680	+105	4	(*)				
K1600 GTL	11' - 20'	TOURING SCREEN WITH VISOR BOLT-ON	9513H				(*)				
K1600 GTL	11' - 20'	TOURING SCREEN WITH CLIP-ON VISOR	9512 + 6375				(*)				
K1600 GRAND AMERICA	18' - 20'	TOURING	9512	695 x 680	+105	4	(*)				
K1600 GRAND AMERICA	18' - 20'	TOURING SCREEN WITH VISOR BOLT-ON	9513H				(*)				
K1600 GRAND AMERICA	18' - 20'	TOURING SCREEN WITH CLIP-ON VISOR	9512 + 6375				(*)				
R NINE T RACER	17' - 20'	TOURING	9402	385 x 360	+25	3	(*)				
R1200GS	04' - 12'	TOURING	4331	530 x 460	+130	4	(*)				
R1200GS	04' - 12'	TOURING SCREEN WITH VISOR BOLT-ON	5916H				(*)				
R1200GS	04' - 12'	TOURING SCREEN WITH CLIP-ON VISOR	4331 + 6319				(*)				
R1200GS	13' - 16'	SPORT	7550	115 x 240		4	(*)				
R1200GS	13' - 18'	SPORT	6487	320 x 340	-120	4	(*)				
R1200GS	13' - 18'	TOURING	6486	545 x 445	+110	4	(*)				
R1200GS	13' - 18'	TOURING SCREEN WITH VISOR BOLT-ON	6504H				(*)				
R1200GS	13' - 18'	TOURING SCREEN WITH CLIP-ON VISOR	6486 + 6375				(*)				
R1200GS	13' - 18'	FIXING SUPPORT REF.6486	7566N				(*)				
R1200GS EXCLUSIVE	17' - 18'	SPORT	6487	320 x 340	-120	4	(*)				
R1200GS EXCLUSIVE	17' - 18'	TOURING	6486	545 x 585	+110	4	(*)				

2021 MODELS: www.puig.tv

MODEL	YEAR	TYPE OF WINDSCREEN	REF.	DIMENSIONS (Height x Width)	HEIGHT (mm) Compared to OEM	THICKNESS (mm)	N H	W F	R V	T A	G C
R1200GS EXCLUSIVE	17' - 18'	TOURING SCREEN WITH VISOR BOLT-ON	6504H				(*)				
R1200GS EXCLUSIVE	17' - 18'	TOURING SCREEN WITH CLIP-ON VISOR	6486 + 6375				(*)				
R1200GS EXCLUSIVE	17' - 18'	FIXING SUPPORT REF.6486	7566N				(*)				
R1200GS RALLYE	17' - 18'	SPORT	6487	320 x 340	-120	4	(*)				
R1200GS RALLYE	17' - 18'	TOURING	6486	545 x 445	+110	4	(*)				
R1200GS RALLYE	17' - 18'	TOURING SCREEN WITH VISOR BOLT-ON	6504H				(*)				
R1200GS RALLYE	17' - 18'	TOURING SCREEN WITH CLIP-ON VISOR	6486 + 6375				(*)				
R1200GS RALLYE	17' - 18'	FIXING SUPPORT REF.6486	7566N				(*)				
R1200GS ADVENTURE	14' - 18'	SPORT	6487	320 x 340	-120	4	(*)				
R1200GS ADVENTURE	14' - 18'	TOURING	6486	545 x 445	+110	4	(*)				
R1200GS ADVENTURE	14' - 18'	TOURING SCREEN WITH VISOR BOLT-ON	6504H				(*)				
R1200GS ADVENTURE	14' - 18'	TOURING SCREEN WITH CLIP-ON VISOR	6486 + 6375				(*)				
R1200GS ADVENTURE	14' - 18'	FIXING SUPPORT REF.6486	7566N				(*)				
R1200GS ADVENTURE	14' - 18'	SPORT	7550	115 x 240		4	(*)				
R1200R	06' - 18'	NEW GENERATION	SEE PAGE 106								
R1200RS	15' - 18'	TOURING	7616	440 x 390	+20	4	(*)			(*)	
R1200RS	15' - 18'	TOURING PLUS	7617	550 x 410	+95	4	(*)				
R1200RS	15' - 18'	TOURING PLUS SCREEN WITH VISOR BOLT-ON	7618H				(*)				
R1200RS	15' - 18'	TOURING PLUS SCREEN WITH CLIP-ON VISOR	7617 + 6320				(*)				
R1200RT	14' - 18'	TOURING	9512	695 x 680	+105	4	(*)				

ANODIZED ALUMINIUM SCREWS AVAILABLE SEE PAGE 72.

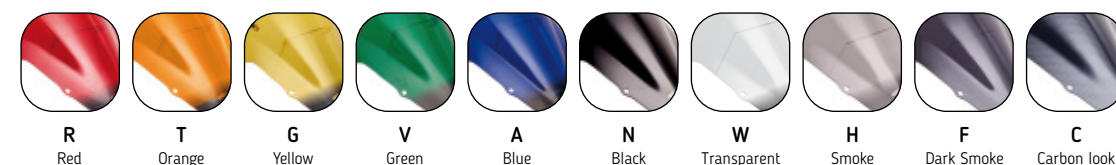

CARBON LOOK: RACING SCREEN AVAILABLE ONLY.
NOTE COLORS: N COLOR DELIVERED WITHOUT SILK PRINT.
 (*) Check price with your distributor.
 (-) Adjustable in width and height.
IMPORTANT: Indicate code color after part#. Example 0973A

WINDSCREEN MODELS

HI-TECH PARTS | TYPE OF WINDSCREEN:



STANDARD
Windscreen without supports, form and height are the same as the original windscreen.

SPORT
Windscreen without supports, lower than the original windscreen.

RACING
Doble height Windscreen, it drives the air away from your helmet, for supersport bikes.

Z-RACING
Windscreen with edges in Z form that drives the air away from the helmet. Slightly taller than the original. Wide range of colors.

R-RACER
Windscreen that comes from competition, without edges. Significantly taller than the original one. Available in smoked colors.

NEW GENERATION
Windscreen with adaptor specifically designed for motorcycles that do not have a screen, especially for Naked models.



TOURING
Windscreen taller than the original to provide more protection to the rider.

TOURING PLUS
Windscreen larger than the Puig Touring model, for certain models of motorcycle tourer for maximum aerodynamic protection.

TOURING WITH VISOR
Higher windscreen than the original that incorporates a multi-adjustable screwed visor to divert air from the rider and provide comfort.

TOURING WITH VISOR "CLIP ON"
Higher windscreen than the original to which is assigned a multi-adjustable visor that is fixed with a system called "clip-on" to divert the air from the rider and provide maximum comfort when driving.

ADJUSTABLE
Windscreen that can be adjusted in height, with or without tools and adjust it to the most suitable position for each rider / situation..

2021 MODELS: www.puig.tv

MODEL	YEAR	TYPE OF WINDSCREEN	REF.	DIMENSIONS (Height x Width)	HEIGHT (mm) Compared to OEM	THICKNESS (mm)	N W H F	R T G V A C
R1200RT	14' - 18'	TOURING SCREEN WITH VISOR BOLT-ON	9513H				(*)	
R1200RT	14' - 18'	TOURING SCREEN WITH CLIP-ON VISOR	9512 + 6375				(*)	
R1200S	06' - 08'	TOURING	4375	340 x 340	-120	3		(*)
R1250GS	18' - 20'	SPORT	6487	320 x 340	-120	4		(*)
R1250GS	18' - 20'	TOURING	6486	545 x 445	+110	4		(*)
R1250GS	18' - 20'	TOURING SCREEN WITH VISOR BOLT-ON	6504H				(*)	
R1250GS	18' - 20'	TOURING SCREEN WITH CLIP-ON VISOR	6486 + 6375				(*)	
R1250GS	18' - 20'	FIXING SUPPORT REF.6486	7566N				(*)	
R1250GS HP	18' - 20'	SPORT	6487	320 x 340	-120	4		(*)
R1250GS HP	18' - 20'	TOURING	6486	545 x 445	+110	4		(*)
R1250GS HP	18' - 20'	TOURING SCREEN WITH VISOR BOLT-ON	6504H				(*)	
R1250GS HP	18' - 20'	TOURING SCREEN WITH CLIP-ON VISOR	6486 + 6375				(*)	
R1250GS HP	18' - 20'	FIXING SUPPORT REF.6486	7566N				(*)	
R1250GS ADVENTURE	18' - 20'	SPORT	6487	320 x 340	-120	4		(*)
R1250GS ADVENTURE	18' - 20'	TOURING	6486	545 x 445	+110	4		(*)
R1250GS ADVENTURE	18' - 20'	TOURING SCREEN WITH VISOR BOLT-ON	6504H				(*)	
R1250GS ADVENTURE	18' - 20'	TOURING SCREEN WITH CLIP-ON VISOR	6486 + 6375				(*)	
R1250GS ADVENTURE	18' - 20'	FIXING SUPPORT REF.6486	7566N				(*)	
R1250 R	19' - 20'	NEW GENERATION	SEE PAGE 107					
R1250RS	19' - 20'	TOURING	7616	440 x 390	+20	4		(*)
R1250RS	19' - 20'	TOURING PLUS	7617	550 x 410	+95	4		(*)
R1250RS	19' - 20'	TOURING PLUS SCREEN WITH VISOR BOLT-ON	7618H				(*)	
R1250RS	19' - 20'	TOURING PLUS SCREEN WITH CLIP-ON VISOR	7617 + 6320				(*)	
R1250RT	19' - 20'	TOURING	9512	695 x 680	+105	4		(*)

2021 MODELS: www.puig.tv

MODEL	YEAR	TYPE OF WINDSCREEN	REF.	DIMENSIONS (Height x Width)	HEIGHT (mm) Compared to OEM	THICKNESS (mm)	N W H F	R T G V A C	
R1250RT	19' - 20'	TOURING SCREEN WITH VISOR BOLT-ON	9513H					(*)	
R1250RT	19' - 20'	TOURING SCREEN WITH CLIP-ON VISOR	9512 + 6375					(*)	
S1000R	14' - 20'	NEW GENERATION	SEE PAGE 107						
S1000RR	09' - 14'	Z-RACING	5205	430 x 300		3		(*) (*)	
S1000RR	15' - 18'	Z-RACING	7564	360 x 440	+30	3		(*) (*)	
S1000RR	19' - 20'	Z-RACING	3571	445 x 425	+40	3		(*) (*)	
S1000RR	19' - 20'	R-RACER	3641	450 x 430	+70	3		(*)	
S1000XR	15' - 19'	SPORT	8543	390 x 345	-30	4		(*) (*)	
S1000XR	15' - 19'	TOURING	7619	515 x 425	+105	4		(*)	
S1000XR	15' - 19'	TOURING SCREEN WITH VISOR BOLT-ON	7620H					(*)	
S1000XR	15' - 19'	TOURING SCREEN WITH CLIP-ON VISOR	7619 + 6320					(*)	
S1000XR	20'	SPORT	20460	378 x 335	-60	4		(*)	
S1000XR	20'	TOURING	20447	565 x 360	+170	4		(*)	
S1000XR	20'	TOURING SCREEN WITH VISOR BOLT-ON	20456H					(*)	
S1000XR	20'	TOURING SCREEN WITH CLIP-ON VISOR	20447+ 6320					(*)	
DUCATI									
749R/749/749S/999/999S/999R	05' - 06'	RACING	2541	420 x 330		3		(*)	
916S/996/998/748		RACING	0955	340 x 310		3		(*)	
848	08' - 10'	RACING	4667	435 x 330		3		(*) (*)	
899 PANIGALE	14' - 15'	R-RACER	5990	400 x 250		3		(*)	
959 PANIGALE	16' - 20'	R-RACER	7621	370 x 250	+30	3		(*)	

ANODIZED ALUMINIUM SCREWS AVAILABLE SEE PAGE 72.

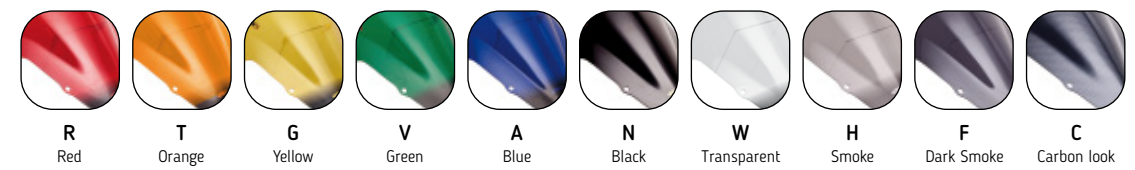

CARBON LOOK: RACING SCREEN AVAILABLE ONLY.
NOTE COLORS: N COLOR DELIVERED WITHOUT SILK PRINT.
 (*) Check price with your distributor.
 (-) Adjustable in width and height.
IMPORTANT: Indicate code color after part#. Example 0973A

WINDSCREEN MODELS

HI-TECH PARTS | TYPE OF WINDSCREEN:



- STANDARD**
Windscreen without supports, form and height are the same as the original windscreen.
- SPORT**
Windscreen without supports, lower than the original windscreen.
- RACING**
Doble height Windscreen, it drives the air away from your helmet, for supersport bikes.
- Z-RACING**
Windscreen with edges in Z form that drives the air away from the helmet. Slightly taller than the original. Wide range of colors.
- R-RACER**
Windscreen that comes from competition, without edges. Significantly taller than the original one. Available in smoked colors.
- NEW GENERATION**
Windscreen with adaptor specifically designed for motorcycles that do not have a screen, especially for Naked models.



- TOURING**
Windscreen taller than the original to provide more protection to the rider.
- TOURING PLUS**
Windscreen larger than the Puig Touring model, for certain models of motorcycle tourer for maximum aerodynamic protection.
- TOURING WITH VISOR**
Higher windscreen than the original that incorporates a multi-adjustable screwed visor to divert air from the rider and provide comfort.
- TOURING WITH VISOR "CLIP ON"**
Higher windscreen than the original to which is assigned a multi-adjustable visor that is fixed with a system called "clip-on" to divert the air from the rider and provide maximum comfort when driving.
- ADJUSTABLE**
Windscreen that can be adjusted in height, with or without tools and adjust it to the most suitable position for each rider / situation..

2021 MODELS: www.puig.tv

MODEL	YEAR	TYPE OF WINDSCREEN	REF.	DIMENSIONS (Height x Width)	HEIGHT (mm) Compared to OEM	THICKNESS (mm)	N H	W F	R V	T A	G C
959 PANIGALE CORSE	18' - 20'	R-RACER	7621	370 x 250	+30	3	(*)				
1098/1098R/1098S	07' - 08'	Z-RACING	4667	435 x 330		3	(*)		(*)		
1198/1198R/1198S	09' - 11'	Z-RACING	4667	435 x 330		3	(*)		(*)		
1199 PANIGALE/S	12' - 15'	R-RACER	5990	400 x 250		3	(*)				
1199 PANIGALE R	15' - 17'	R-RACER	5990	400 x 250		3	(*)				
1199 SUPERLEGGERA	14'	R-RACER	5990	400 x 250		3	(*)				
1299 PANIGALE/S	15' - 17'	R-RACER	7621	370 x 250	+30	3	(*)				
PANIGALE R	15' - 17'	R-RACER	7621	370 x 250	+30	3	(*)				
PANIGALE V2	20'	R-RACER	9690	400 x 275	+30	3	(*)				
PANIGALE 1100 V4	18' - 19'	R-RACER	9690	400 x 275	+30	3	(*)				
PANIGALE 1100 V4	20'	R-RACER	3759	400 x 275	+30	3	(*)				
PANIGALE 1100 V4 R	18' - 20'	R-RACER	3759	400 x 275	+30	3	(*)				
PANIGALE 1100 V4S	18' - 19'	R-RACER	9690	400 x 275	+30	3	(*)				
PANIGALE 1100 V4S	20'	R-RACER	3759	400 x 275	+30	3	(*)				
DIAVEL	11' - 18'	NEW GENERATION	SEE PAGE 107								
DIAVEL 1260/S	19' - 20'	NEW GENERATION	SEE PAGE 107								
X DIAVEL/S	16' - 18'	NEW GENERATION	SEE PAGE 107								
HYPERMOTARD 796	10' - 13'	NEW GENERATION	SEE PAGE 107								
HYPERMOTARD 1100	07' - 09'	NEW GENERATION	SEE PAGE 107								
HYPERMOTARD 1100 S	10' - 12'	NEW GENERATION	SEE PAGE 107								
HYPERMOTARD 821/SP	13' - 15'	NEW GENERATION	SEE PAGE 107								
HYPERMOTARD 939/SP	16' - 18'	NEW GENERATION	SEE PAGE 107								
HYPERMOTARD 950/SP	19' - 20'	NEW GENERATION	SEE PAGE 107								
MONSTER 696	08' - 14'	NEW GENERATION	SEE PAGE 107								
MONSTER 796	10' - 14'	NEW GENERATION	SEE PAGE 107								
MONSTER 797	17' - 20'	NEW GENERATION	SEE PAGE 107								
MONSTER 821	14' - 20'	NEW GENERATION	SEE PAGE 107								
MONSTER 1100/S	09' - 10'	NEW GENERATION	SEE PAGE 107								
MONSTER 1100 EVO	11' - 13'	NEW GENERATION	SEE PAGE 107								

2021 MODELS: www.puig.tv

MODEL	YEAR	TYPE OF WINDSCREEN	REF.	DIMENSIONS (Height x Width)	HEIGHT (mm) Compared to OEM	THICKNESS (mm)	N H	W F	R V	T A	G C
MONSTER 1200/S	14' - 20'	NEW GENERATION	SEE PAGE 107								
MONSTER 1200 R	16' - 20'	NEW GENERATION	SEE PAGE 107								
MULTISTRADA 950	17' - 20'	SPORT	7622	440 x 295	-80	3	(*)		(*)		
MULTISTRADA 950	17' - 20'	TOURING	7623	605 x 335	+85	4	(*)				
MULTISTRADA 950	17' - 20'	TOURING SCREEN WITH VISOR BOLT-ON	7624H						(*)		
MULTISTRADA 950	17' - 20'	TOURING SCREEN WITH CLIP-ON VISOR	7623 + 6319						(*)		
MULTISTRADA 950 S	19' - 20'	SPORT	7622	440 x 295	-80	3	(*)		(*)		
MULTISTRADA 950 S	19' - 20'	TOURING	7623	605 x 335	+85	4	(*)				
MULTISTRADA 950 S	19' - 20'	TOURING SCREEN WITH VISOR BOLT-ON	7624H						(*)		
MULTISTRADA 950 S	19' - 20'	TOURING SCREEN WITH CLIP-ON VISOR	7623 + 6319						(*)		
MULTISTRADA 1200/S	10' - 12'	TOURING	6273	390 x 290	+65	3	(*)		(*)		
MULTISTRADA 1200/S	10' - 12'	TOURING PLUS	5250	573 x 330	+65	3	(*)		(*)		
MULTISTRADA 1200/S	13' - 14'	SPORT	6490	430 x 290	-85	4	(*)		(*)		
MULTISTRADA 1200/S	13' - 14'	TOURING	6491	580 x 405	+65	4	(*)		(*)		
MULTISTRADA 1200/S	13' - 14'	TOURING SCREEN WITH VISOR BOLT-ON	6505H						(*)		
MULTISTRADA 1200/S	13' - 14'	TOURING SCREEN WITH CLIP-ON VISOR	6491 + 6320						(*)		
MULTISTRADA 1200/S	15' - 17'	SPORT	7622	440 x 295	-80	3	(*)		(*)		
MULTISTRADA 1200/S	15' - 17'	TOURING	7623	605 x 335	+85	4	(*)		(*)		
MULTISTRADA 1200/S	15' - 17'	TOURING SCREEN WITH VISOR BOLT-ON	7624H						(*)		
MULTISTRADA 1200/S	15' - 17'	TOURING SCREEN WITH CLIP-ON VISOR	7623 + 6319						(*)		

ANODIZED ALUMINIUM SCREWS AVAILABLE SEE PAGE 72.

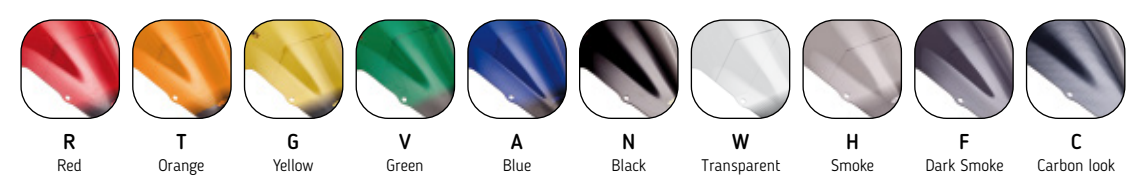

CARBON LOOK: RACING SCREEN AVAILABLE ONLY.
NOTE COLORS: N COLOR DELIVERED WITHOUT SILK PRINT.
 (*) Check price with your distributor.
 (-) Adjustable in width and height.
IMPORTANT: Indicate code color after part#. Example 0973A

WINDSCREEN MODELS

HI-TECH PARTS | TYPE OF WINDSCREEN:

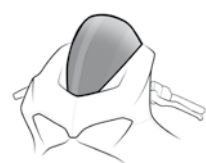

STANDARD

Windscreen without supports, form and height are the same as the original windscreen.



SPORT

Windscreen without supports, lower than the original windscreen.



RACING

Doble height Windscreen, it drives the air away from your helmet, for supersport bikes.

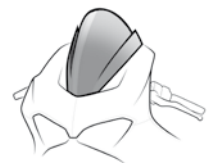

Z-RACING

Windscreen with edges in Z form that drives the air away from the helmet. Slightly taller than the original. Wide range of colors.



R-RACER

Windscreen that comes from competition, without edges. Significantly taller than the original one. Available in smoked colors.

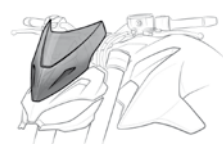

NEW GENERATION

Windscreen with adaptor specifically designed for motorcycles that do not have a screen, especially for Naked models.



TOURING

Windscreen taller than the original to provide more protection to the rider.



TOURING PLUS

Windscreen larger than the Puig Touring model, for certain models of motorcycle tourer for maximum aerodynamic protection.



TOURING WITH VISOR

Higher windscreen than the original that incorporates a multi-adjustable screwed visor to divert air from the rider and provide comfort.



TOURING WITH VISOR "CLIP ON"

Higher windscreen than the original that is assigned a multi-adjustable visor that is fixed with a system called "clip-on" to divert the air from the rider and provide maximum comfort when driving.

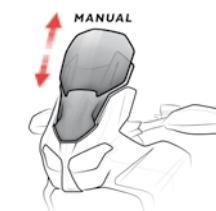

ADJUSTABLE

Windscreen that can be adjusted in height, with or without tools and adjust it to the most suitable position for each rider / situation..

2021 MODELS: www.puig.tv

MODEL	YEAR	TYPE OF WINDSCREEN	REF.	DIMENSIONS (Height x Width)	HEIGHT (mm) Compared to OEM	THICKNESS (mm)	N W H F	R T G V A C
MULTISTRADA 1200 ENDURO/PRO	16' - 18'	SPORT	7622	440 x 295	-80	3	(*)	(*)
MULTISTRADA 1200 ENDURO/PRO	16' - 18'	TOURING	7623	605 x 335	+85	4	(*)	
MULTISTRADA 1200 ENDURO/PRO	16' - 18'	TOURING SCREEN WITH VISOR BOLT-ON	7624H				(*)	
MULTISTRADA 1200 ENDURO/PRO	16' - 18'	TOURING SCREEN WITH CLIP-ON VISOR	7623 + 6319				(*)	
MULTISTRADA 1260/S/S DJAIR	18' - 20'	SPORT	7622	440 x 295	-80	3	(*)	(*)
MULTISTRADA 1260/S/S DJAIR	18' - 20'	TOURING	7623	605 x 335	+85	4	(*)	
MULTISTRADA 1260/S/S DJAIR	18' - 20'	TOURING SCREEN WITH VISOR BOLT-ON	7624H				(*)	
MULTISTRADA 1260/S/S DJAIR	18' - 20'	TOURING SCREEN WITH CLIP-ON VISOR	7623 + 6319				(*)	
MULTISTRADA 1260 PIKES PEAK	18' - 20'	SPORT	7622	440 x 295	-80	3	(*)	(*)
MULTISTRADA 1260 PIKES PEAK	18' - 20'	TOURING	7623	605 x 335	+85	4	(*)	
MULTISTRADA 1260 PIKES PEAK	18' - 20'	TOURING SCREEN WITH VISOR BOLT-ON	7624H				(*)	
MULTISTRADA 1260 PIKES PEAK	18' - 20'	TOURING SCREEN WITH CLIP-ON VISOR	7623 + 6319				(*)	
MULTISTRADA 1260 ENDURO	19' - 20'	SPORT	7622	440 x 295	-80	3	(*)	(*)
MULTISTRADA 1260 ENDURO	19' - 20'	TOURING	7623	605 x 335	+85	4	(*)	
MULTISTRADA 1260 ENDURO	19' - 20'	TOURING SCREEN WITH VISOR BOLT-ON	7624H				(*)	
MULTISTRADA 1260 ENDURO	19' - 20'	TOURING SCREEN WITH CLIP-ON VISOR	7623 + 6319				(*)	
MULTISTRADA 1260 S GRAND TOUR	20'	SPORT	7622	440 x 295	-80	3	(*)	(*)
MULTISTRADA 1260 S GRAND TOUR	20'	TOURING	7623	605 x 335	+85	4	(*)	
Original fairing MONSTER 696/796/1100		STANDARD	5890	160 x 220		3	(*)	
Original fairing MONSTER 696/796/1100		TOURING	5650	260 x 220	+100	3	(*)	(*)
SUPERSPORT 939/S	17' - 20'	TOURING	9434	405 x 290	+75	3	(*)	(*)
STREETFIGHTER V4/S	19' - 20'	NEW GENERATION	SEE PAGE 107					
HARLEY DAVIDSON								
SPORTSTER 883		NEW GENERATION	SEE PAGE 107					
SPORTSTER 1200		NEW GENERATION	SEE PAGE 107					

2021 MODELS: www.puig.tv

MODEL	YEAR	TYPE OF WINDSCREEN	REF.	DIMENSIONS (Height x Width)	HEIGHT (mm) Compared to OEM	THICKNESS (mm)	N W H F	R T G V A C
SPORTSTER FORTY-EIGHT	10' - 20'	NEW GENERATION	SEE PAGE 108					
SPORTSTER SEVENTY-TWO	13' - 16'	NEW GENERATION	SEE PAGE 108					
HONDA								
CB125F	15' - 18'	NEW GENERATION	SEE PAGE 108					
CB125R NEO SPORTS CAFE	18' - 20'	NEW GENERATION	SEE PAGE 108					
CB300F	15' - 16'	NEW GENERATION	SEE PAGE 108					
CB300R NEO SPORTS CAFE	18' - 20'	NEW GENERATION	SEE PAGE 108					
CB500F	13' - 20'	NEW GENERATION	SEE PAGE 108					
CB500X	13' - 15'	TOURING	6480	485 x 350	+165	3	(*)	
CB500X	13' - 15'	TOURING SCREEN WITH VISOR BOLT-ON	6992H				(*)	
CB500X	13' - 15'	TOURING SCREEN WITH CLIP-ON VISOR	6480 + 6319				(*)	
CB500X	16' - 20'	TOURING	8901	520 x 310	+105	3	(*)	(*)
CB500X	16' - 20'	TOURING SCREEN WITH VISOR BOLT-ON	8902H				(*)	
CB500X	16' - 20'	TOURING SCREEN WITH CLIP-ON VISOR	8901 + 6319				(*)	(*)
CB600F HORNET	05' - 06'	NEW GENERATION	SEE PAGE 108					
CB600F HORNET	07' - 10'	NEW GENERATION	SEE PAGE 108					
CB600F HORNET	11' - 15'	NEW GENERATION	SEE PAGE 108					
CB650F	14' - 18'	NEW GENERATION	SEE PAGE 108					
CB650R NEO SPORTS CAFE	19' - 20'	NEW GENERATION	SEE PAGE 108					
CB1000R	08' - 10'	NEW GENERATION	SEE PAGE 108					
CB1000R	11' - 16'	NEW GENERATION	SEE PAGE 108					
CB1000R NEO SPORTS CAFE	18' - 20'	NEW GENERATION	SEE PAGE 108					

ANODIZED ALUMINIUM SCREWS AVAILABLE SEE PAGE 72.

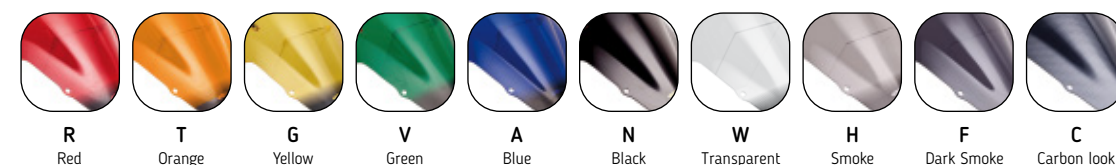

CARBON LOOK: RACING SCREEN AVAILABLE ONLY.
NOTE COLORS: N COLOR DELIVERED WITHOUT SILK PRINT.
 (*) Check price with your distributor.
 (-) Adjustable in width and height.
IMPORTANT: Indicate code color after part#. Example 0973A

WINDSCREEN MODELS

HI-TECH PARTS | TYPE OF WINDSCREEN:



STANDARD
Windscreen without supports, form and height are the same as the original windscreen.

SPORT
Windscreen without supports, lower than the original windscreen.

RACING
Doble height Windscreen, it drives the air away from your helmet, for supersport bikes.

Z-RACING
Windscreen with edges in Z form that drives the air away from the helmet. Slightly taller than the original. Wide range of colors.

R-RACER
Windscreen that comes from competition, without edges. Significantly taller than the original one. Available in smoked colors.

NEW GENERATION
Windscreen with adaptor specifically designed for motorcycles that do not have a screen, especially for Naked models.



TOURING
Windscreen taller than the original to provide more protection to the rider.

TOURING PLUS
Windscreen larger than the Puig Touring model, for certain models of motorcycle tourer for maximum aerodynamic protection.

TOURING WITH VISOR
Higher windscreen than the original that incorporates a multi-adjustable screwed visor to divert air from the rider and provide comfort.

TOURING WITH VISOR "CLIP ON"
Higher windscreen than the original to which is assigned a multi-adjustable visor that is fixed with a system called "clip-on" to divert the air from the rider and provide maximum comfort when driving.

ADJUSTABLE
Windscreen that can be adjusted in height, with or without tools and adjust it to the most suitable position for each rider / situation..

2021 MODELS: www.puig.tv

MODEL	YEAR	TYPE OF WINDSCREEN	REF.	DIMENSIONS (Height x Width)	HEIGHT (mm) Compared to OEM	THICKNESS (mm)	N H	W F	R V	T A	G C
CB1300S	05' - 13'	TOURING	4098	470 x 320	+100	3	(*)	(*)			
CB1300S	05' - 13'	TOURING SCREEN WITH VISOR BOLT-ON	5900H				(*)				
CB1300S	05' - 13'	TOURING SCREEN WITH CLIP-ON VISOR	4098 + 6319				(*)	(*)			
CB1300SB	10' - 16'	TOURING	3558	470 x 330	+265	4	(*)				
CBF1000F	10' - 16'	TOURING	5252	470 x 340	+100	3	(*)				
CBF1000F	10' - 16'	TOURING SCREEN WITH VISOR BOLT-ON	5899H				(*)				
CBF1000F	10' - 16'	TOURING SCREEN WITH CLIP-ON VISOR	5252 + 6320				(*)				
CBR125R	11' - 16'	Z-RACING	5641	420 x 280		3	(*)	(*)			
CBR250R	11' - 15'	Z-RACING	5643	420 x 340		3	(*)	(*)			
CBR300R	15' - 17'	Z-RACING	7228	315 x 240		3	(*)	(*)			
CBR500R	13' - 15'	Z-RACING	6479	315 X 285	+40	3	(*)	(*)			
CBR500R	16' - 18'	Z-RACING	8903	330 x 275	+30	3	(*)	(*)			
CBR500R	19' - 20'	Z-RACING	3613	305 x 265	+25	3	(*)	(*)			
CBR500R	19' - 20'	Z-RACING	3568	335 x 285	+30	3	(*)	(*)			
CBR600RR	05' - 06'	RACING	2058	280 x 320		3	(*)				
CBR600RR	07' - 12'	RACING	4356	340 x 315		3	(*)	(*)			
CBR600RR	13' - 16'	Z-RACING	6478	240 x 280	+30	3	(*)	(*)			
CBR600F	01' - 07'	RACING	0861	400 x 370		3	(*)	(*)			
CBR650F	14' - 20'	Z-RACING	7003	355 x 310	+30	3	(*)	(*)			
CBR650F	14' - 20'	TOURING	7595	435 x 375	+110	3	(*)	(*)			
CBR650F	14' - 20'	TOURING SCREEN WITH VISOR BOLT-ON	7601H				(*)				
CBR650F	14' - 20'	TOURING SCREEN WITH CLIP-ON VISOR	7595 + 6320				(*)				
CBR900RR FIRE BLADE	02' - 03'	RACING	1100	320 x 400		3	(*)				
CBR1000RR FIRE BLADE	04' - 07'	Z-RACING	1665	370 x 330	+25	3	(*)	(*)			
CBR1000RR FIRE BLADE	08' - 11'	STANDARD	4622	290 x 300		3			(*)		
CBR1000RR FIRE BLADE	08' - 11'	RACING	4623	290 x 285		3	(*)	(*)			

2021 MODELS: www.puig.tv

MODEL	YEAR	TYPE OF WINDSCREEN	REF.	DIMENSIONS (Height x Width)	HEIGHT (mm) Compared to OEM	THICKNESS (mm)	N H	W F	R V	T A	G C
CBR1000RR FIRE BLADE	12' - 13'	Z-RACING	5994	340 x 300	+40	3	(*)		(*)		
CBR1000RR FIREBLADE/SP	14' - 16'	Z-RACING	5994	340 x 300	+40	3	(*)		(*)		
CBR1000RR FIREBLADE/SP/SP2	17' - 18'	Z-RACING	9407	330 x 245	+30	3	(*)		(*)		
CBR1000RR FIREBLADE/SP/SP2	17' - 19'	R-RACER	3630	345 x 245	+200	3	(*)				
CBR1000RR FIREBLADE/SP	20'	Z-RACING	20313	335 x 270		3	(*)		(*)		
CBR1000RR FIREBLADE/SP	20'	R-RACER	20314	335 x 270		3	(*)				
CBR1100XX BLACKBIRD	97' - 07'	TOURING	0283	450 x 445		3	(*)	(*)			
CRF1000L AFRICA TWIN	16' - 19'	SPORT	8904	415 x 290	-50	4	(*)	(*)			
CRF1000L AFRICA TWIN	16' - 19'	ADJUSTABLE	9155	415 x 290	+30	4	(*)				
CRF1000L AFRICA TWIN	16' - 19'	TOURING	8905	590 x 355	+90	4	(*)	(*)			
CRF1000L AFRICA TWIN	16' - 19'	TOURING SCREEN WITH VISOR BOLT-ON	8906H				(*)				
CRF1000L AFRICA TWIN	16' - 19'	TOURING SCREEN WITH CLIP-ON VISOR	8905 + 6319				(*)	(*)			
CRF1100L AFRICA TWIN	20'	TOURING	3818	480 x 320	+150 - +125	4	(*)	(*)			
CRF1100L AFRICA TWIN	20'	TOURING SCREEN WITH VISOR BOLT-ON	3819H				(*)				
CRF1100L AFRICA TWIN	20'	TOURING SCREEN WITH CLIP-ON VISOR	3818 + 6320				(*)				
CRF1000L AFRICA TWIN ADVENTURE SPORTS	18' - 19'	SPORT	8904	415 x 290	-50	4	(*)	(*)			
CRF1000L AFRICA TWIN ADVENTURE SPORTS	18' - 19'	ADJUSTABLE	9155	415 x 290	+30	4	(*)				
CRF1000L AFRICA TWIN ADVENTURE SPORTS	18' - 19'	TOURING	8905	590 x 355	+90	4	(*)	(*)			
CRF1000L AFRICA TWIN ADVENTURE SPORTS	18' - 19'	TOURING SCREEN WITH VISOR BOLT-ON	8906H				(*)				
CRF1000L AFRICA TWIN ADVENTURE SPORTS	18' - 19'	TOURING SCREEN WITH CLIP-ON VISOR	8905 + 6319				(*)	(*)			
CRF1100L AFRICA TWIN ADVENTURE SPORTS	20'	SPORT	3820	450 x 295	-55	4	(*)				

ANODIZED ALUMINIUM SCREWS AVAILABLE SEE PAGE 72.

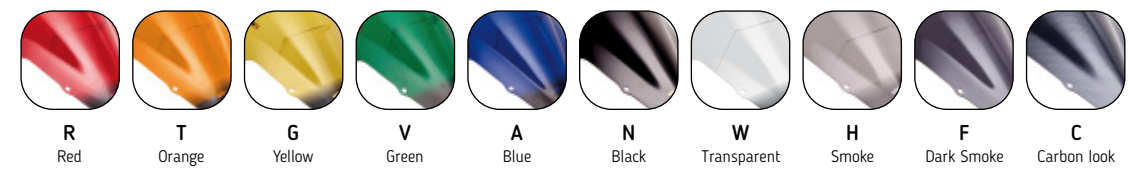

CARBON LOOK: RACING SCREEN AVAILABLE ONLY.
NOTE COLORS: N COLOR DELIVERED WITHOUT SILK PRINT.
 (*) Check price with your distributor.
 (-) Adjustable in width and height.
IMPORTANT: Indicate code color after part#. Example 0973A

WINDSCREEN MODELS

HI-TECH PARTS | TYPE OF WINDSCREEN:

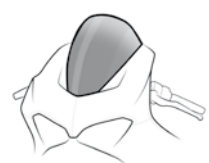

STANDARD

Windscreen without supports, form and height are the same as the original windscreen.



SPORT

Windscreen without supports, lower than the original windscreen.



RACING

Doble height Windscreen, it drives the air away from your helmet, for supersport bikes.

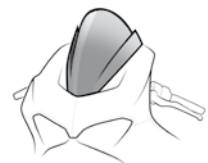

Z-RACING

Windscreen with edges in Z form that drives the air away from the helmet. Slightly taller than the original. Wide range of colors.



R-RACER

Windscreen that comes from competition, without edges. Significantly taller than the original one. Available in smoked colors.



NEW GENERATION

Windscreen with adaptor specifically designed for motorcycles that do not have a screen, especially for Naked models.



TOURING

Windscreen taller than the original to provide more protection to the rider.



TOURING PLUS

Windscreen larger than the Puig Touring model, for certain models of motorcycle tourer for maximum aerodynamic protection.



TOURING WITH VISOR

Higher windscreen than the original that incorporates a multi-adjustable screwed visor to divert air from the rider and provide comfort.



TOURING WITH VISOR "CLIP ON"

Higher windscreen than the original to which is assigned a multi-adjustable visor that is fixed with a system called "clip-on" to divert the air from the rider and provide maximum comfort when driving.



ADJUSTABLE

Windscreen that can be adjusted in height, with or without tools and adjust it to the most suitable position for each rider / situation..

2021 MODELS: www.puig.tv

MODEL	YEAR	TYPE OF WINDSCREEN	REF.	DIMENSIONS (Height x Width)	HEIGHT (mm) Compared to OEM	THICKNESS (mm)	N H	W F	R V	T A	G C
CMX 300 REBEL	17' - 20'	NEW GENERATION	SEE PAGE 108								
CMX 500 REBEL	17' - 20'	NEW GENERATION	SEE PAGE 108								
CROSSRUNNER	11' - 14'	TOURING	5639	480 x 470	+180	3	(*)				(*)
CROSSRUNNER	15' - 16'	TOURING	7626	570 x 435	+150	4	(*)				
CROSSRUNNER	15' - 16'	TOURING SCREEN WITH VISOR BOLT-ON	7627H				(*)				
CROSSRUNNER	15' - 16'	TOURING SCREEN WITH CLIP-ON VISOR	7626 + 6375				(*)				
CROSSRUNNER	17' - 20'	TOURING	9444	570 x 435	+150	4	(*)				
CROSSRUNNER	17' - 20'	TOURING SCREEN WITH VISOR BOLT-ON	9445H				(*)				
CROSSRUNNER	17' - 20'	TOURING SCREEN WITH CLIP-ON VISOR	9444 + 6375				(*)				
CROSSTOURER	12' - 15'	TOURING	5993	510 x 470	+165	3	(*)				
CROSSTOURER	12' - 15'	TOURING SCREEN WITH VISOR BOLT-ON	6003H				(*)				
CROSSTOURER	12' - 15'	TOURING SCREEN WITH CLIP-ON VISOR	5993 + 6375				(*)				
CTX700	14' - 16'	TOURING	7227	510 x 580	+280	4	(*)				
CTX700N	14' - 16'	NEW GENERATION	SEE PAGE 108								
CTX1300	14' - 16'	TOURING	7005	580 x 570	+325	4	(*)				
CTX1300	14' - 16'	TOURING SCREEN WITH VISOR BOLT-ON	7006H				(*)				
CTX1300	14' - 16'	TOURING SCREEN WITH CLIP-ON VISOR	7005 + 6375				(*)				
GL1800 GOLD WING	18' - 20'	TOURING	3160	730 x 685	+150	4	(*)				
NC700S	12' - 13'	TOURING	5991	340 x 295	+285	3	(*)				(*)
NC700S	12' - 13'	TOURING PLUS	6361	430 x 320	+285	3	(*)				(*)
NC700S	12' - 13'	TOURING PLUS SCREEN WITH VISOR BOLT-ON	6001H				(*)				
NC700S	12' - 13'	TOURING PLUS SCREEN WITH CLIP-ON VISOR	6361 + 6319				(*)				(*)
NC750S	14' - 20'	TOURING	5991	340 x 295	+285	3	(*)				(*)
NC750S	14' - 20'	TOURING PLUS	6361	430 x 320	+285	3	(*)				(*)

2021 MODELS: www.puig.tv

MODEL	YEAR	TYPE OF WINDSCREEN	REF.	DIMENSIONS (Height x Width)	HEIGHT (mm) Compared to OEM	THICKNESS (mm)	N H	W F	R V	T A	G C
NC750S	14' - 20'	TOURING PLUS SCREEN WITH VISOR BOLT-ON	6001H								(*)
NC750S	14' - 20'	TOURING PLUS SCREEN WITH CLIP-ON VISOR	6361 + 6319								(*)
NC700X	12' - 13'	TOURING	5992	480 x 420	+150	3	(*)				
NC700X	12' - 13'	TOURING SCREEN WITH VISOR BOLT-ON	6002H				(*)				
NC700X	12' - 13'	TOURING SCREEN WITH CLIP-ON VISOR	5992 + 6319				(*)				
NC750X	14' - 15'	TOURING	5992	480 x 420	+150	3	(*)				
NC750X	14' - 15'	TOURING SCREEN WITH VISOR BOLT-ON	6002H				(*)				
NC750X	14' - 15'	TOURING SCREEN WITH CLIP-ON VISOR	5992 + 6319				(*)				
NC750X	16' - 20'	SPORT	8909	300 x 270	-110	3	(*)				
NC750X	16' - 20'	TOURING	8910	520 x 325	+115	3	(*)				(*)
NC750X	16' - 20'	TOURING SCREEN WITH VISOR BOLT-ON	8911H				(*)				
NC750X	16' - 20'	TOURING SCREEN WITH CLIP-ON VISOR	8910 + 6320				(*)				(*)
NT650V DEAUVILLE	98' - 05'	TOURING	0414	550 x 380	+210	3	(*)				
PAN-EUROPEAN	02' - 13'	TOURING	5995	590 x 630	+70	4	(*)				(*)
PAN-EUROPEAN	02' - 13'	TOURING SCREEN WITH VISOR BOLT-ON	7591H				(*)				
PAN-EUROPEAN	02' - 13'	TOURING SCREEN WITH CLIP-ON VISOR	5995 + 6375				(*)				(*)
ST1100 PAN EUROPEAN	90' - 01'	TOURING	0190	560 x 520	+125	3	(*)				
ST1100 PAN EUROPEAN	90' - 01'	TOURING SCREEN WITH VISOR BOLT-ON	5902H				(*)				

ANODIZED ALUMINIUM SCREWS AVAILABLE SEE PAGE 72.

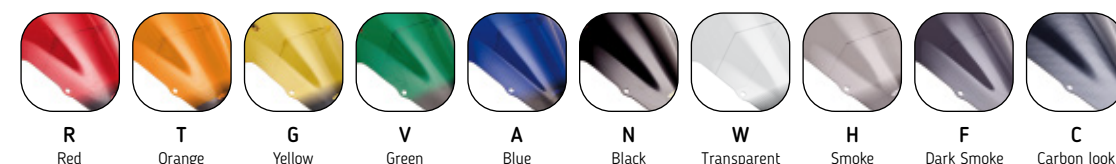

CARBON LOOK: RACING SCREEN AVAILABLE ONLY.
NOTE COLORS: N COLOR DELIVERED WITHOUT SILK PRINT.
 (*) Check price with your distributor.
 (-) Adjustable in width and height.
IMPORTANT: Indicate code color after part#. Example 0973A

WINDSCREEN MODELS

HI-TECH PARTS | TYPE OF WINDSCREEN:



STANDARD

Windscreen without supports, form and height are the same as the original windscreen.



SPORT

Windscreen without supports, lower than the original windscreen.



RACING

Doble height Windscren, it drives the air away from your helmet, for supersport bikes.



Z-RACING

Windscreen with edges in Z form that drives the air away from the helmet. Slightly taller than the original. Wide range of colors.



R-RACER

Windscreen that comes from competition, without edges. Significantly taller than the original one. Available in smoked colors.



NEW GENERATION

Windscreen with adaptor specifically designed for motorcycles that do not have a screen, especially for Naked models.



TOURING

Windscreen taller than the original to provide more protection to the rider.



TOURING PLUS

Windscreen larger than the Puig Touring model, for certain models of motorcycle tourer for maximum aerodynamic protection.



TOURING WITH VISOR

Higher windscreen than the original that incorporates a multi-adjustable screwed visor to divert air from the rider and provide comfort.



TOURING WITH VISOR "CLIP ON"

Higher windscreen than the original to which is assigned a multi-adjustable visor that is fixed with a system called "clip-on" to divert the air from the rider and provide maximum comfort when driving.



ADJUSTABLE

Windscreen that can be adjusted in height, with or without tools and adjust it to the most suitable position for each rider / situation..

2021 MODELS: www.puig.tv

MODEL	YEAR	TYPE OF WINDSCREEN	REF.	DIMENSIONS (Height x Width)	HEIGHT (mm) Compared to OEM	THICKNESS (mm)	N H	W F	R V	T A	G C
ST1100 PAN EUROPEAN	90' - 01'	TOURING SCREEN WITH CLIP-ON VISOR	0190 + 6375				(*)				
VFR800	02' - 13'	RACING	1097	390 x 390		3	(*)				
VFR800F	14' - 18'	Z-RACING	7598	435 x 340	+30	3	(*)		(*)		
VFR800F	14' - 18'	TOURING	7007	540 x 400	+130	3	(*)				
VFR800F	14' - 18'	TOURING SCREEN WITH VISOR BOLT-ON	7008H				(*)				
VFR800F	14' - 18'	TOURING SCREEN WITH CLIP-ON VISOR	7007 + 6320				(*)				
VFR1200F	10' - 16'	Z-RACING	5251	450 X 410	+30	3	(*)		(*)		
XL650V TRANSALP	00' - 07'	TOURING	0377	530 x 380	+165	3	(*)				
X-ADV	17' - 20'	TOURING	9709	655 x 430	+115	4	(*)				
X-ADV	17' - 20'	TOURING SCREEN WITH VISOR BOLT-ON	9712H				(*)				
X-ADV	17' - 20'	TOURING SCREEN WITH CLIP-ON VISOR	9709 + 6320				(*)				
HUSQVARNA											
701 ENDURO	16' - 20'	NEW GENERATION	SEE PAGE 108								
NUDA 900/R	12' - 14'	NEW GENERATION	SEE PAGE 108								
SVARTPILEN 401	17' - 20'	NEW GENERATION	SEE PAGE 108								
VITPILEN 401	17' - 20'	NEW GENERATION	SEE PAGE 108								
VITPILEN 701	17' - 20'	NEW GENERATION	SEE PAGE 108								
HYOSUNG											
GT125R	06' - 13'	RACING	4184	370 x 365		3	(*)		(*)		
GT250Ri	06' -18'	RACING	4184	370 x 365		3	(*)		(*)		
GT650R	05' - 17'	RACING	4184	370 x 365		3	(*)		(*)		
GT650Ri	13' - 20'	Z-RACING	6716	385 x 355	+55	3	(*)		(*)		
INDIAN											
FTR 1200/S	19' - 20'	NEW GENERATION	SEE PAGE 108								
SCOUT	15' - 20'	NEW GENERATION	SEE PAGE 109								
KAWASAKI											
ER-6F	06' - 08'	TOURING	4106	415 x 355	+40	3	(*)				

2021 MODELS: www.puig.tv

MODEL	YEAR	TYPE OF WINDSCREEN	REF.	DIMENSIONS (Height x Width)	HEIGHT (mm) Compared to OEM	THICKNESS (mm)	N H	W F	R V	T A	G C
ER-6F	09' - 11'	TOURING	4931	460 x 330		3	(*)		(*)		
ER-6F	12' - 16'	TOURING	5998	540 x 450	+100	3	(*)		(*)		
ER-6F	12' - 16'	TOURING SCREEN WITH VISOR BOLT-ON	6004H				(*)				
ER-6F	12' - 16'	TOURING SCREEN WITH CLIP-ON VISOR	5998 + 6375				(*)		(*)		
ER-6N	05' - 08'	NEW GENERATION	SEE PAGE 109								
ER-6N	09' - 11'	NEW GENERATION	SEE PAGE 109								
ER-6N	12' - 16'	NEW GENERATION	SEE PAGE 109								
GTR1400	07' - 09'	TOURING	4619	680 x 570	+195	4	(*)				
GTR1400	07' - 09'	TOURING SCREEN WITH VISOR BOLT-ON	5904H				(*)				
GTR1400	07' - 09'	TOURING SCREEN WITH CLIP-ON VISOR	4619 + 6375				(*)				
GTR1400	10' - 14'	TOURING	4619	680 x 570	+130	4	(*)				
GTR1400	10' - 14'	TOURING SCREEN WITH VISOR BOLT-ON	5904H				(*)				
GTR1400	10' - 14'	TOURING SCREEN WITH CLIP-ON VISOR	4619 + 6375				(*)				
GTR1400	15' - 17'	TOURING	7628	705 x 580	+105	4	(*)				
GTR1400	15' - 17'	TOURING SCREEN WITH VISOR BOLT-ON	7629H				(*)				
GTR1400	15' - 17'	TOURING SCREEN WITH CLIP-ON VISOR	7628 + 6375				(*)				
KLE500	05' - 07'	TOURING	1520	430 x 270		3	(*)				
KLV1000	04' - 05'	TOURING	1880	515 x 415	+120	3	(*)				
NINJA 125	19' - 20'	Z-RACING	3539	295 x 285	+30	3	(*)		(*)		
NINJA 250R	08' - 12'	RACING	4626	340 x 325		3	(*)		(*)		

ANODIZED ALUMINIUM SCREWS AVAILABLE SEE PAGE 72.

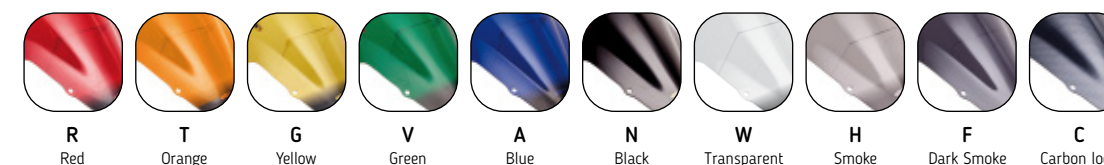

CARBON LOOK: RACING SCREEN AVAILABLE ONLY.
NOTE COLORS: N COLOR DELIVERED WITHOUT SILK PRINT.
 (*) Check price with your distributor.
 (-) Adjustable in width and height.
IMPORTANT: Indicate code color after part#. Example 0973A

WINDSCREEN MODELS

HI-TECH PARTS | TYPE OF WINDSCREEN:

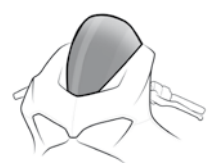

STANDARD

Windscreen without supports, form and height are the same as the original windscreen.



SPORT

Windscreen without supports, lower than the original windscreen.



RACING

Doble height Windscree, it drives the air away from your helmet, for supersport bikes.

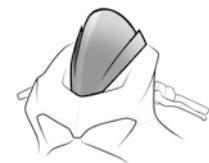

Z-RACING

Windscreen with edges in Z form that drives the air away from the helmet. Slightly taller than the original. Wide range of colors.



R-RACER

Windscreen that comes from competition, without edges. Significantly taller than the original one. Available in smoked colors.



NEW GENERATION

Windscreen with adaptor specifically designed for motorcycles that do not have a screen, especially for Naked models.



TOURING

Windscreen taller than the original to provide more protection to the rider.



TOURING PLUS

Windscreen larger than the Puig Touring model, for certain models of motorcycle tourer for maximum aerodynamic protection.



TOURING WITH VISOR

Higher windscreen than the original that incorporates a multi-adjustable screwed visor to divert air from the rider and provide comfort.



TOURING WITH VISOR "CLIP ON"

Higher windscreen than the original to which is assigned a multi-adjustable visor that is fixed with a system called "clip-on" to divert the air from the rider and provide maximum comfort when driving.



ADJUSTABLE

Windscreen that can be adjusted in height, with or without tools and adjust it to the most suitable position for each rider / situation..

2021 MODELS: www.puig.tv

MODEL	YEAR	TYPE OF WINDSCREEN	REF.	DIMENSIONS (Height x Width)	HEIGHT (mm) Compared to OEM	THICKNESS (mm)	N H	W F	R V	T A	G C
NINJA 250SL	15' - 16'	Z-RACING	7630	345 x 270	+65	3	(*)	(*)			
NINJA 300	13' - 17'	Z-RACING	6463	415 x 355	+40	3	(*)	(*)			
NINJA 400	18' - 20'	Z-RACING	9976	400 x 335	+30	3	(*)	(*)			
NINJA 650	17' - 19'	Z-RACING	9711	450 x 310	+65	3	(*)				
NINJA 650	20'	R-RACER	3880	455 x 385	+20	3	(*)				
NINJA 650	20'	Z-RACING	3881	485 x 385	+20	3	(*)				
NINJA H2	15' - 20'	Z-RACING	7631	330 x 330	+30	3	(*)				
NINJA H2 SX	18' - 20'	Z-RACING	9704	400 x 390	+15	3	(*)	(*)			
NINJA 1000 SX	20'	RACING	20471			3	(*)	(*)			
VERSYS-X 300	17' - 20'	TOURING	9710	520 x 310	+115	3	(*)				
VERSYS-X 300	17' - 20'	TOURING SCREEN WITH VISOR BOLT-ON	9713H				(*)				
VERSYS-X 300	17' - 20'	TOURING SCREEN WITH CLIP-ON VISOR	9710 + 5852				(*)				
VERSYS 650	07' - 09'	TOURING	4360	370 x 340	+75	3	(*)				
VERSYS 650	10' - 14'	TOURING	5255	400 x 315	+60	3	(*)				
VERSYS 650	10' - 14'	TOURING SCREEN WITH VISOR BOLT-ON	5905H				(*)				
VERSYS 650	10' - 14'	TOURING SCREEN WITH CLIP-ON VISOR	5255 + 6319				(*)				
VERSYS 650	15' - 16'	TOURING	9421	500 x 450	+130	3	(*)				
VERSYS 650	17' - 20'	TOURING	9421	500 x 450	+130	3	(*)				
VERSYS 1000	12' - 16'	TOURING	9421	500 x 450	+130	3	(*)				
VERSYS 1000	17' - 20'	TOURING	9421	500 x 450	+130	3	(*)				
VERSYS 1000 SE	19' - 20'	TOURING	3640	555 x 487	+70	4	(*)				
VERSYS 1000 SE	19' - 20'	TOURING SCREEN WITH VISOR BOLT-ON	3731H				(*)				
VERSYS 1000 SE	19' - 20'	TOURING SCREEN WITH CLIP-ON VISOR	3640 + 6375				(*)				
VERSYS 1000 TOURER	19' - 20'	TOURING	3640	555 x 487	+70	4	(*)				
VERSYS 1000 TOURER	19' - 20'	TOURING SCREEN WITH VISOR BOLT-ON	3731H				(*)				

2021 MODELS: www.puig.tv

MODEL	YEAR	TYPE OF WINDSCREEN	REF.	DIMENSIONS (Height x Width)	HEIGHT (mm) Compared to OEM	THICKNESS (mm)	N H	W F	R V	T A	G C
VERSYS 1000 TOURER	19' - 20'	TOURING SCREEN WITH CLIP-ON VISOR	3640 + 6375				(*)				
VERSYS 1000 GRAND TOURER	19' - 20'	TOURING	3640	555 x 487	+70	4	(*)				
VERSYS 1000 GRAND TOURER	19' - 20'	TOURING SCREEN WITH VISOR BOLT-ON	3731H				(*)				
VERSYS 1000 GRAND TOURER	19' - 20'	TOURING SCREEN WITH CLIP-ON VISOR	3640 + 6375				(*)				
VERSYS 1000 TOURER PLUS	19' - 20'	TOURING	3640	555 x 487	+70	4	(*)				
VERSYS 1000 TOURER PLUS	19' - 20'	TOURING SCREEN WITH VISOR BOLT-ON	3731H				(*)				
VERSYS 1000 TOURER PLUS	19' - 20'	TOURING SCREEN WITH CLIP-ON VISOR	3640 + 6375				(*)				
VULCAN S	15' - 20'	NEW GENERATION	SEE PAGE 109								
VULCAN S CAFE	17' - 20'	NEW GENERATION	SEE PAGE 109								
Z125	19' - 20'	NEW GENERATION	SEE PAGE 109								
Z250SL	15' - 16'	NEW GENERATION	SEE PAGE 109								
Z300	15' - 17'	NEW GENERATION	SEE PAGE 109								
Z400	19' - 20'	NEW GENERATION	SEE PAGE 109								
Z650	17' - 20'	NEW GENERATION	SEE PAGE 109								
Z750S	05' - 06'	TOURING	2087	390 x 295		3	(*)		(*)		
Z750	07' - 12'	NEW GENERATION	SEE PAGE 109								
Z750R	11' - 12'	NEW GENERATION	SEE PAGE 109								
Z800	13' - 16'	NEW GENERATION	SEE PAGE 109								
Z800E	13' - 16'	NEW GENERATION	SEE PAGE 109								
Z900	17' - 20'	NEW GENERATION	SEE PAGE 109								
Z1000	03' - 06'	STANDARD	1336			3					(*)
Z1000	03' - 06'	TOURING	1520	430 x 270		3	(*)				

ANODIZED ALUMINIUM SCREWS AVAILABLE SEE PAGE 72.

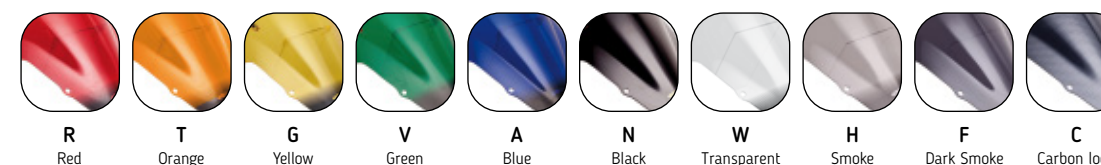

CARBON LOOK: RACING SCREEN AVAILABLE ONLY.
NOTE COLORS: N COLOR DELIVERED WITHOUT SILK PRINT.
 (*) Check price with your distributor.
 (-) Adjustable in width and height.
IMPORTANT: Indicate code color after part#. Example 0973A

WINDSCREEN MODELS

HI-TECH PARTS | TYPE OF WINDSCREEN:



STANDARD

Windscreen without supports, form and height are the same as the original windscreen.



SPORT

Windscreen without supports, lower than the original windscreen.



RACING

Doble height Windscreen, it drives the air away from your helmet, for supersport bikes.

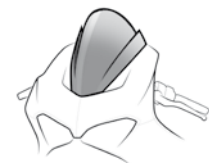

Z-RACING

Windscreen with edges in Z form that drives the air away from the helmet. Slightly taller than the original. Wide range of colors.



R-RACER

Windscreen that comes from competition, without edges. Significantly taller than the original one. Available in smoked colors.



NEW GENERATION

Windscreen with adaptor specifically designed for motorcycles that do not have a screen, especially for Naked models.



TOURING

Windscreen taller than the original to provide more protection to the rider.



TOURING PLUS

Windscreen larger than the Puig Touring model, for certain models of motorcycle tourer for maximum aerodynamic protection.



TOURING WITH VISOR

Higher windscreen than the original that incorporates a multi-adjustable screwed visor to divert air from the rider and provide comfort.



TOURING WITH VISOR "CLIP ON"

Higher windscreen than the original that is assigned a multi-adjustable visor that is fixed with a system called "clip-on" to divert the air from the rider and provide maximum comfort when driving.



ADJUSTABLE

Windscreen that can be adjusted in height, with or without tools and adjust it to the most suitable position for each rider / situation..

2021 MODELS: www.puig.tv

MODEL	YEAR	TYPE OF WINDSCREEN	REF.	DIMENSIONS (Height x Width)	HEIGHT (mm) Compared to OEM	THICKNESS (mm)	N H	W F	R V	T A	G C
Z1000	07' - 09'	TOURING	4361	370 x 295		3	(*)	(*)			
Z1000	10' - 13'	NEW GENERATION	SEE PAGE 109								
Z1000	14' - 20'	NEW GENERATION	SEE PAGE 109								
Z1000R	17' - 20'	NEW GENERATION	SEE PAGE 109								
Z1000SX	11' - 16'	Z-RACING	9408	505 x 400	+53	3	(*)	(*)			
Z1000SX	17' - 19'	Z-RACING	9408	470 X 380		3	(*)	(*)			
ZRX1200R	97' - 06'	TOURING	0426	365 x 325	+117	3	(*)	(*)			
ZRX1200S	01' - 07'	STANDARD	0059			3			(*)		
ZX-6R	01' - 02'	Z-RACING	0514	430 x 385		3	(*)	(*)			
ZX-6R	03' - 04'	Z-RACING	1335	340 x 430		3			(*)		
ZX-6R	05' - 08'	Z-RACING	4053	400 x 360		3	(*)	(*)			
ZX-6R	09' - 16'	Z-RACING	6482	340 x 350	+25	3			(*)		
ZX-6R 636	13' - 16'	Z-RACING	6482	340 x 350	+25	3			(*)		
ZX-6R 636	13' - 16'	R-RACER	3629	370 x 350	+40	3	(*)				
ZX-6R 636	19' - 20'	Z-RACING	3177	350 x 350	+15	3	(*)	(*)			
ZX-6R 636	19' - 20'	R-RACER	3629	350 x 350	+40	3	(*)				
ZX-9R	94' - 97'	STANDARD	0344			3	(*)				
ZX-9R	00' - 04'	RACING	0565	390 x 350		3	(*)	(*)			
ZX-10R	04' - 05'	RACING	1657	380 x 300		3			(*)		
ZX-10R	06' - 07'	STANDARD	4052	360 x 360		3	(*)				
ZX-10R	06' - 07'	RACING	4053	400 x 360		3	(*)	(*)			
ZX-10R	08' - 10'	Z-RACING	6482	340 x 350	+25	3			(*)		
ZX-10R	11' - 15'	STANDARD	5602	410 x 390		3	(*)				
ZX-10R	11' - 15'	Z-RACING	5603	410 x 365		3	(*)	(*)			
ZX-10R	16' - 20'	Z-RACING	8912	350 x 300	+40	3	(*)	(*)			
ZX-10R	16' - 20'	R-RACER	9849	360 x 325	+10	3	(*)				
ZX-10RR	17' - 20'	Z-RACING	8912	350 x 300	+40	3	(*)	(*)			
ZX-10RR	17' - 20'	R-RACER	9849	360 x 325	+10	3	(*)				
ZX-10R SE	18' - 20'	Z-RACING	8912	350 x 300	+40	3	(*)	(*)			

2021 MODELS: www.puig.tv

MODEL	YEAR	TYPE OF WINDSCREEN	REF.	DIMENSIONS (Height x Width)	HEIGHT (mm) Compared to OEM	THICKNESS (mm)	N H	W F	R V	T A	G C
ZX-10R SE	18' - 20'	R-RACER	9849	360 x 325	+10	3	(*)				
ZX-10R KRT REPLICA	18' - 20'	Z-RACING	8912	350 x 300	+40	3	(*)		(*)		
ZX-10R KRT REPLICA	18' - 20'	R-RACER	9849	360 x 325	+10	3	(*)				
ZX-12R	00' - 01'	TOURING	0422	480 x 375	+78	3	(*)	(*)			
ZX-12R	02' - 06'	STANDARD	1121	390 x 380		3	(*)	(*)			
ZZR600	93' - 06'	TOURING	0207	420 x 380	+39			(*)			
ZZR1400	06' - 20'	STANDARD	4056	390 x 375		3	(*)				
ZZR1400	06' - 20'	RACING	4057	440 x 360	+25	3	(*)	(*)			
KTM											
125 DUKE	11' - 20'	NEW GENERATION	SEE PAGE 109								
200 DUKE	12 - 15'	NEW GENERATION	SEE PAGE 109								
390 DUKE	13' - 20'	NEW GENERATION	SEE PAGE 109								
390 ADVENTURE	20'	TOURING	20414	500 x 330	+200				(*)		
390 ADVENTURE	20'	TOURING SCREEN WITH VISOR BOLT-ON	20415H						(*)		
390 ADVENTURE	20'	TOURING SCREEN WITH CLIP-ON VISOR	20414 + 6320						(*)		
690 DUKE	08' - 11'	NEW GENERATION	SEE PAGE 109								
690 DUKE	12' - 20'	NEW GENERATION	SEE PAGE 109								
690 DUKE R	10' - 11'	NEW GENERATION	SEE PAGE 109								
690 DUKE R	13' - 17'	NEW GENERATION	SEE PAGE 109								
690 ENDURO R	19' - 20'	NEW GENERATION	SEE PAGE 109								
690 SMC R	19' - 20'	NEW GENERATION	SEE PAGE 109								
790 DUKE	18' - 20'	NEW GENERATION	SEE PAGE 110								
790 ADVENTURE/R	19' - 20'	SPORT	3738	366 x 348	-70	4	(*)				

ANODIZED ALUMINIUM SCREWS AVAILABLE SEE PAGE 72.

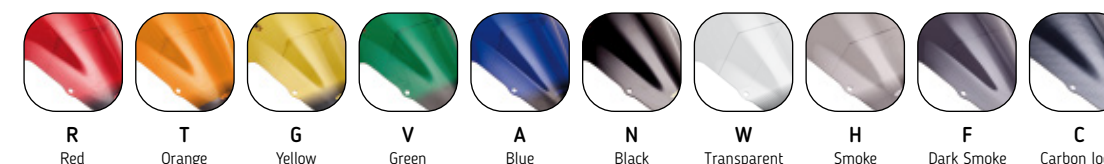

CARBON LOOK: RACING SCREEN AVAILABLE ONLY.
NOTE COLORS: N COLOR DELIVERED WITHOUT SILK PRINT.
 (*) Check price with your distributor.
 (-) Adjustable in width and height.
IMPORTANT: Indicate code color after part#. Example 0973A

WINDSCREEN MODELS

HI-TECH PARTS | TYPE OF WINDSCREEN:



STANDARD

Windscreen without supports, form and height are the same as the original windscreen.



SPORT

Windscreen without supports, lower than the original windscreen.



RACING

Doble height Windscresn, it drives the air away from your helmet, for supersport bikes.

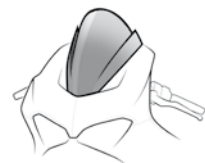

Z-RACING

Windscreen with edges in Z form that drives the air away from the helmet. Slightly taller than the original. Wide range of colors.



R-RACER

Windscreen that comes from competition, without edges. Significantly taller than the original one. Available in smoked colors.

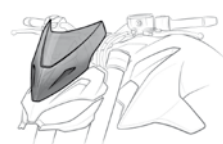

NEW GENERATION

Windscreen with adaptor specifically designed for motorcycles that do not have a screen, especially for Naked models.



TOURING

Windscreen taller than the original to provide more protection to the rider.



TOURING PLUS

Windscreen larger than the Puig Touring model, for certain models of motorcycle tourer for maximum aerodynamic protection.



TOURING WITH VISOR

Higher windscreen than the original that incorporates a multi-adjustable screwed visor to divert air from the rider and provide comfort.



TOURING WITH VISOR "CLIP ON"

Higher windscreen than the original to which is assigned a multi-adjustable visor that is fixed with a system called "clip-on" to divert the air from the rider and provide maximum comfort when driving.



ADJUSTABLE

Windscreen that can be adjusted in height, with or without tools and adjust it to the most suitable position for each rider / situation..

2021 MODELS: www.puig.tv

MODEL	YEAR	TYPE OF WINDSCREEN	REF.	DIMENSIONS (Height x Width)	HEIGHT (mm) Compared to OEM	THICKNESS (mm)	N W H F	R T G V A C
790 ADVENTURE/R	19' - 20'	TOURING	3587	525 x 385	+110	4	(*)	
790 ADVENTURE/R	19' - 20'	TOURING SCREEN WITH VISOR BOLT-ON	3588H				(*)	
790 ADVENTURE/R	19' - 20'	TOURING SCREEN WITH CLIP-ON VISOR	3587+ 6375				(*)	
790 ADVENTURE R RALLY	20'	SPORT	3738	366 x 348	-70	4	(*)	
790 ADVENTURE R RALLY	20'	TOURING	3587	525 x 385	+110	4	(*)	
790 ADVENTURE R RALLY	20'	TOURING SCREEN WITH VISOR BOLT-ON	3588H				(*)	
790 ADVENTURE R RALLY	20'	TOURING SCREEN WITH CLIP-ON VISOR	3587 + 6375				(*)	
950 SUPERMOTO	05' - 07'	NEW GENERATION	SEE PAGE 110					
950 SUPERMOTO R	07' - 08'	NEW GENERATION	SEE PAGE 110					
950 SUPERENDURO	06' - 09'	NEW GENERATION	SEE PAGE 110					
990 SUPERDUKE/R	07' - 13'	NEW GENERATION	SEE PAGE 110					
990 SUPERMOTO	08' - 13'	NEW GENERATION	SEE PAGE 110					
990 SUPERMOTO R	09' - 13'	NEW GENERATION	SEE PAGE 110					
990 SUPERMOTO T	09' - 12'	TOURING	6495	510 x 400	+170	4	(*)	(*)
1050 ADVENTURE	15' - 16'	SPORT	6847	315 x 310	-125	3	(*)	
1050 ADVENTURE	15' - 16'	TOURING	6494	510 x 420	+50	3	(*)	(*)
1090 ADVENTURE/R	17' - 20'	SPORT	6847	315 x 310	-125	3	(*)	
1090 ADVENTURE/R	17' - 20'	TOURING	6494	510 x 420	+50	3	(*)	(*)
1190 ADVENTURE/R	13' - 16'	SPORT	6847	315 x 310	-125	3	(*)	
1190 ADVENTURE/R	13' - 16'	TOURING	6494	510 x 420	+50	3	(*)	(*)
1190 RC8/R	08' - 15'	Z-RACING	4944	370 x 350	+50	3	(*)	
1290 SUPERDUKE R	14' - 20'	NEW GENERATION	SEE PAGE 110					
1290 SUPERDUKE GT	16' - 18'	TOURING	8913	600 x 440	+135	4	(*)	(*)
1290 SUPERDUKE GT	16' - 18'	TOURING SCREEN WITH VISOR BOLT-ON	8914H				(*)	
1290 SUPERDUKE GT	16' - 18'	TOURING SCREEN WITH CLIP-ON VISOR	8913 + 6320				(*)	
1290 SUPERDUKE GT	19' - 20'	TOURING	3564	540 x 420	+115 - + 165	4	(*)	

2021 MODELS: www.puig.tv

MODEL	YEAR	TYPE OF WINDSCREEN	REF.	DIMENSIONS (Height x Width)	HEIGHT (mm) Compared to OEM	THICKNESS (mm)	N W H F	R T G V A C
1290 SUPERDUKE GT	19' - 20'	TOURING SCREEN WITH VISOR BOLT-ON	3565H				(*)	
1290 SUPERDUKE GT	19' - 20'	TOURING SCREEN WITH CLIP-ON VISOR	3564 + 6375				(*)	
1290 SUPER ADVENTURE	15' - 16'	SPORT	6847	315 x 310	-125	3	(*)	
1290 SUPER ADVENTURE	15' - 16'	TOURING	6494	510 x 420	+50	3	(*)	(*)
1290 SUPER ADVENTURE T	17'	SPORT	6847	315 x 310	-125	3	(*)	
1290 SUPER ADVENTURE T	17'	TOURING	6494	510 x 420	+50	3	(*)	(*)
1290 SUPER ADVENTURE R	17' - 20'	SPORT	9716	290 x 310	-105	4	(*)	
1290 SUPER ADVENTURE R	17' - 20'	TOURING	9717	490 x 420	+75	4	(*)	
1290 SUPER ADVENTURE R	17' - 20'	TOURING SCREEN WITH VISOR BOLT-ON	9714H				(*)	
1290 SUPER ADVENTURE R	17' - 20'	TOURING SCREEN WITH CLIP-ON VISOR	9717 + 6375				(*)	
1290 SUPER ADVENTURE S	17' - 20'	SPORT	9716	290 x 310	-105	4	(*)	
1290 SUPER ADVENTURE S	17' - 20'	TOURING	9717	490 x 420	+75	4	(*)	
1290 SUPER ADVENTURE S	17' - 20'	TOURING SCREEN WITH VISOR BOLT-ON	9714H				(*)	
1290 SUPER ADVENTURE S	17' - 20'	TOURING SCREEN WITH CLIP-ON VISOR	9717 + 6375				(*)	
RC125/RC390	14' - 20'	Z-RACING	7004	410 x 320	+100	3	(*)	
MV AGUSTA								
BRUTALE	05' - 09'	NEW GENERATION	SEE PAGE 110					
BRUTALE 675	12' - 18'	NEW GENERATION	SEE PAGE 110					
BRUTALE 800/RR	13' - 20'	NEW GENERATION	SEE PAGE 110					
BRUTALE DRAGSTER 800/RR	14' - 20'	NEW GENERATION	SEE PAGE 110					

ANODIZED ALUMINIUM SCREWS AVAILABLE SEE PAGE 72.

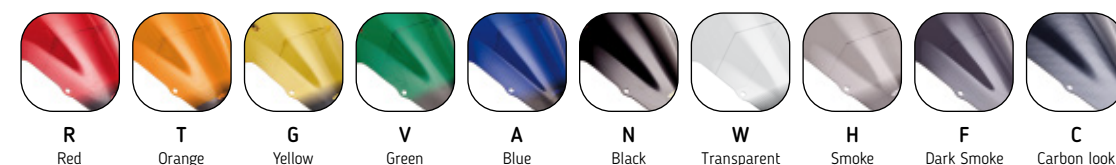

CARBON LOOK: RACING SCREEN AVAILABLE ONLY.
NOTE COLORS: N COLOR DELIVERED WITHOUT SILK PRINT.
 (*) Check price with your distributor.
 (-) Adjustable in width and height.
IMPORTANT: Indicate code color after part#. Example 0973A

WINDSCREEN MODELS

HI-TECH PARTS | TYPE OF WINDSCREEN:

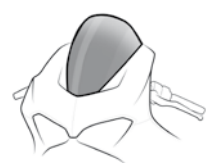

STANDARD

Windscreen without supports, form and height are the same as the original windscreen.



SPORT

Windscreen without supports, lower than the original windscreen.



RACING

Doble height Windscree, it drives the air away from your helmet, for supersport bikes.

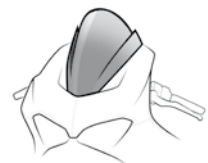

Z-RACING

Windscreen with edges in Z form that drives the air away from the helmet. Slightly taller than the original. Wide range of colors.



R-RACER

Windscreen that comes from competition, without edges. Significantly taller than the original one. Available in smoked colors.

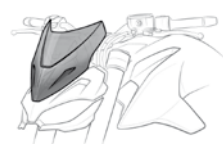

NEW GENERATION

Windscreen with adaptor specifically designed for motorcycles that do not have a screen, especially for Naked models.

2021 MODELS: www.puig.tv

MODEL	YEAR	TYPE OF WINDSCREEN	REF.	DIMENSIONS (Height x Width)	HEIGHT (mm) Compared to OEM	THICKNESS (mm)	N W H F	R T G V A C	
BRUTALE 920	11' - 12'	NEW GENERATION	SEE PAGE 110						
BRUTALE 1090	13' - 18'	NEW GENERATION	SEE PAGE 110						
BRUTALE 1090 RR	10' - 18'	NEW GENERATION	SEE PAGE 110						
F3 675	12' - 20'	Z-RACING	5651	330 x 325	+40	3	(*)		
F3 800	13' - 20'	Z-RACING	5651	330 x 325	+40	3	(*)	(*)	
F4	10' - 20'	Z-RACING	5256	410 x 370		3	(*)		
F4 1000 RR	13' - 20'	Z-RACING	5256	410 x 370		3	(*)		
RIVALE 800	13' - 18'	NEW GENERATION	SEE PAGE 110						
STRADALE 800	15' - 16'	TOURING	7634	485 x 365	+120	3	(*)		
STRADALE 800	15' - 16'	TOURING SCREEN WITH VISOR BOLT-ON	7635H				(*)		
STRADALE 800	15' - 16'	TOURING SCREEN WITH CLIP-ON VISOR	7634 + 6320				(*)		
TURISMO VELOCE 800/LUSSO	14' - 20'	TOURING	7017	485 x 290	+100	3	(*)		
TURISMO VELOCE 800/LUSSO	14' - 20'	TOURING SCREEN WITH VISOR BOLT-ON	7018H				(*)		
TURISMO VELOCE 800/LUSSO	14' - 20'	TOURING SCREEN WITH CLIP-ON VISOR	7017 + 6319				(*)		
SUZUKI									
B-KING	08' - 11'	NEW GENERATION	SEE PAGE 110						
DL250 V-STROM	17' - 20'	TOURING	9606	440 x 435	+95	4	(*)		
DL250 V-STROM	17' - 20'	TOURING SCREEN WITH VISOR BOLT-ON	9607H				(*)		
DL250 V-STROM	17' - 20'	TOURING SCREEN WITH CLIP-ON VISOR	9606 + 6320				(*)		
DL650 V-STROM	04' - 11'	TOURING	1880	512 x 420	+120	3	(*)		
DL650 V-STROM	04' - 11'	TOURING SCREEN WITH VISOR BOLT-ON	5883H				(*)		
DL650 V-STROM	04' - 11'	TOURING SCREEN WITH CLIP-ON VISOR	1880 + 6375				(*)		
DL650 V-STROM	12' - 16'	TOURING	5895	540 x 430	+120	3	(*)	(*)	
DL650 V-STROM	12' - 16'	TOURING SCREEN WITH VISOR BOLT-ON	6253H				(*)		



TOURING

Windscreen taller than the original to provide more protection to the rider.

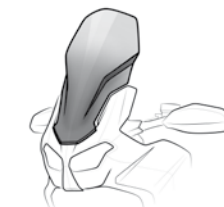

TOURING PLUS

Windscreen larger than the Puig Touring model, for certain models of motorcycle tourer for maximum aerodynamic protection.



TOURING WITH VISOR

Higher windscreen than the original that incorporates a multi-adjustable screwed visor to divert air from the rider and provide comfort.



TOURING WITH VISOR "CLIP ON"

Higher windscreen than the original to which is assigned a multi-adjustable visor that is fixed with a system called "clip-on" to divert the air from the rider and provide maximum comfort when driving.



ADJUSTABLE

Windscreen that can be adjusted in height, with or without tools and adjust it to the most suitable position for each rider / situation..

2021 MODELS: www.puig.tv

MODEL	YEAR	TYPE OF WINDSCREEN	REF.	DIMENSIONS (Height x Width)	HEIGHT (mm) Compared to OEM	THICKNESS (mm)	N W H F	R T G V A C
DL650 V-STROM	12' - 16'	TOURING SCREEN WITH CLIP-ON VISOR	5895 + 6320				(*)	(*)
DL650 V-STROM	17' - 20'	TOURING	9719	440 x 445	+120	4	(*)	
DL650 V-STROM	17' - 20'	TOURING SCREEN WITH VISOR BOLT-ON	9440H				(*)	
DL650 V-STROM	17' - 20'	TOURING SCREEN WITH CLIP-ON VISOR	9719 + 6320				(*)	
DL650XT V-STROM	15' - 16'	TOURING	5895	540 x 430	+120	3	(*)	(*)
DL650XT V-STROM	15' - 16'	TOURING SCREEN WITH VISOR BOLT-ON	6253H				(*)	
DL650XT V-STROM	15' - 16'	TOURING SCREEN WITH CLIP-ON VISOR	5895 + 6320				(*)	(*)
DL650XT V-STROM	17' - 20'	TOURING	9719	440 x 445	+120	4	(*)	
DL650XT V-STROM	17' - 20'	TOURING SCREEN WITH VISOR BOLT-ON	9440H				(*)	
DL650XT V-STROM	17' - 20'	TOURING SCREEN WITH CLIP-ON VISOR	9719 + 6320				(*)	
DL1000 V-STROM	02' - 07'	TOURING	1880	515 x 420	+120	3	(*)	
DL1000 V-STROM	14' - 20'	TOURING	7229	460 x 435	+165	4	(*)	
DL1000 V-STROM	14' - 20'	TOURING SCREEN WITH VISOR BOLT-ON	7230H				(*)	
DL1000 V-STROM	14' - 20'	TOURING SCREEN WITH CLIP-ON VISOR	7229 + 6320				(*)	
DL1000XT V-STROM	17' - 20'	TOURING	7229	460 x 435	+165	4	(*)	
DL1000XT V-STROM	17' - 20'	TOURING SCREEN WITH VISOR BOLT-ON	7230H				(*)	
DL1000XT V-STROM	17' - 20'	TOURING SCREEN WITH CLIP-ON VISOR	7229 + 6320				(*)	
DL1050 V-STROM	20'	TOURING	20411	630 x 480	+95	4	(*)	

ANODIZED ALUMINIUM SCREWS AVAILABLE SEE PAGE 72.

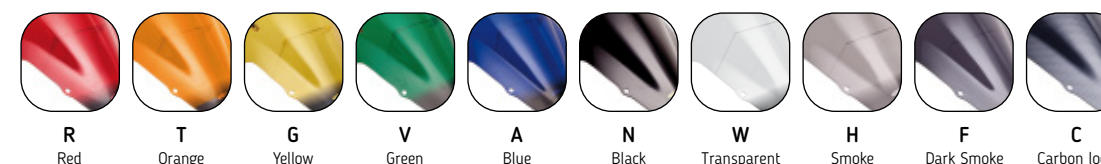

CARBON LOOK: RACING SCREEN AVAILABLE ONLY.
NOTE COLORS: N COLOR DELIVERED WITHOUT SILK PRINT.
 (*) Check price with your distributor.
 (-) Adjustable in width and height.
IMPORTANT: Indicate code color after part#. Example 0973A

WINDSCREEN MODELS

HI-TECH PARTS | TYPE OF WINDSCREEN:



STANDARD

Windscreen without supports, form and height are the same as the original windscreen.

SPORT

Windscreen without supports, lower than the original windscreen.

RACING

Doble height Windscreen, it drives the air away from your helmet, for supersport bikes.

Z-RACING

Windscreen with edges in Z form that drives the air away from the helmet. Slightly taller than the original. Wide range of colors.

R-RACER

Windscreen that comes from competition, without edges. Significantly taller than the original one. Available in smoked colors.

NEW GENERATION

Windscreen with adaptor specifically designed for motorcycles that do not have a screen, especially for Naked models.



TOURING

Windscreen taller than the original to provide more protection to the rider.

TOURING PLUS

Windscreen larger than the Puig Touring model, for certain models of motorcycle tourer for maximum aerodynamic protection.

TOURING WITH VISOR

Higher windscreen than the original that incorporates a multi-adjustable screwed visor to divert air from the rider and provide comfort.

TOURING WITH VISOR "CLIP ON"

Higher windscreen than the original that is assigned a multi-adjustable visor that is fixed with a system called "clip-on" to divert the air from the rider and provide maximum comfort when driving.

ADJUSTABLE

Windscreen that can be adjusted in height, with or without tools and adjust it to the most suitable position for each rider / situation..

2021 MODELS: www.puig.tv

MODEL	YEAR	TYPE OF WINDSCREEN	REF.	DIMENSIONS (Height x Width)	HEIGHT (mm) Compared to OEM	THICKNESS (mm)	N W H F	R T G V A C
DL1050 V-STROM	20'	TOURING SCREEN WITH VISOR BOLT-ON	20412H				(*)	(*)
DL1050 V-STROM	20'	TOURING SCREEN WITH CLIP-ON VISOR	20411 + 6320				(*)	(*)
DL1050XT V-STROM	20'	TOURING	20411	630 x 480	+95	4	(*)	(*)
DL1050XT V-STROM	20'	TOURING SCREEN WITH VISOR BOLT-ON	20412H				(*)	(*)
DL1050XT V-STROM	20'	TOURING SCREEN WITH CLIP-ON VISOR	20411 + 6320				(*)	(*)
GSF600S BANDIT	00' - 04'	STANDARD	0697			3	(*)	(*)
GSF650 BANDIT	09' - 11'	NEW GENERATION	SEE PAGE 110					
GSF650S BANDIT	05' - 08'	RACING	2107	340 x 360		3	(*)	(*)
GSF650S BANDIT	05' - 08'	TOURING	2125	410 x 360	+80	3	(*)	(*)
GSF1200S BANDIT	01' - 05'	STANDARD	0697			3	(*)	(*)
GSF1200S BANDIT	06'	RACING	2107	340 x 360		3	(*)	(*)
GSF1200S BANDIT	06'	TOURING	2125	410 x 355	+80	3	(*)	(*)
GSF1250 BANDIT	10' - 13'	NEW GENERATION	SEE PAGE 110					
GSF1250S BANDIT	07' - 16'	RACING	2107	340 x 360		3	(*)	(*)
GSF1250S BANDIT	07' - 16'	TOURING	2125	410 x 355	+80	3	(*)	(*)
GSR600	06' - 11'	NEW GENERATION	SEE PAGE 110					
GSR750	11' - 16'	NEW GENERATION	SEE PAGE 110					
GSX650F	08' - 16'	RACING	4665	340 x 400		3	(*)	(*)
GSX650F	08' - 16'	TOURING	4633	450 x 395	+110	3	(*)	(*)
GSX1250F	10' - 17'	RACING	4665	340 x 400		3	(*)	(*)
GSX1250F	10' - 17'	TOURING	4633	450 x 395	+110	3	(*)	(*)
GSX-R125	17' - 20'	Z-RACING	9721	340 x 305	+10	3	(*)	(*)
GSX-R250	17' - 20'	Z-RACING	9722	365 x 300	+45	3	(*)	(*)
GSX-R600	98' - 00'	RACING	0950	430 x 395		3	(*)	(*)
GSX-R600	98' - 00'	TOURING	0798	450 x 415	+50	3	(*)	(*)
GSX-R600	01' - 03'	STANDARD	0053	400 x 420		3	(*)	(*)
GSX-R600	01' - 03'	RACING	0189	400 x 430		3	(*)	(*)

2021 MODELS: www.puig.tv

MODEL	YEAR	TYPE OF WINDSCREEN	REF.	DIMENSIONS (Height x Width)	HEIGHT (mm) Compared to OEM	THICKNESS (mm)	N W H F	R T G V A C
GSX-R750	98' - 99'	RACING	0950	430 x 395		3	(*)	(*)
GSX-R750	98' - 99'	TOURING	0798	450 x 415	+50	3	(*)	(*)
GSX-R750	00' - 03'	STANDARD	0053	400 x 420		3	(*)	(*)
GSX-R750	00' - 03'	RACING	0189	400 x 430		3	(*)	(*)
GSX-R600/750	04' - 05'	STANDARD	1654	350 x 330		3	(*)	(*)
GSX-R600/750	04' - 05'	RACING	1655	350 x 320		3	(*)	(*)
GSX-R600/750	06' - 07'	RACING	4055	355 x 320		3	(*)	(*)
GSX-R600/750	08' - 10'	Z-RACING	4629	350 x 325		3	(*)	(*)
GSX-R600/750	11' - 16'	Z-RACING	5605	280 x 300		3	(*)	(*)
GSX-R1000	01' - 02'	STANDARD	0053	400 x 420		3	(*)	(*)
GSX-R1000	01' - 02'	RACING	0189	400 x 430		3	(*)	(*)
GSX-R1000	03' - 04'	STANDARD	1338			3	(*)	(*)
GSX-R1000	03' - 04'	RACING	1340	400 x 470		3	(*)	(*)
GSX-R1000	05' - 06'	STANDARD	2071	320 x 320		3	(*)	(*)
GSX-R1000	05' - 06'	RACING	2072	310 x 300		3	(*)	(*)
GSX-R1000	07' - 08'	STANDARD	4362			3	(*)	(*)
GSX-R1000	07' - 08'	RACING	4363	320 x 330		3	(*)	(*)
GSX-R1000	09' - 15'	STANDARD	4932	370 x 330		3	(*)	(*)
GSX-R1000	09' - 16'	Z-RACING	4933	360 x 340		3	(*)	(*)
GSX-R1000/R	17' - 20'	Z-RACING	9013	310 x 275		3	(*)	(*)
GSX-R1000/R	17' - 20'	R-RACER	3631	288 x 285	+60	3	(*)	(*)
GSX-R1300 HAYABUSA	99' - 07'	RACING	0953	370 x 450		3	(*)	(*)
GSX-R1300 HAYABUSA	08' - 17'	STANDARD	4825	400 x 440		3	(*)	(*)
GSX-R1300 HAYABUSA	08' - 17'	RACING	4826	390 x 440		3	(*)	(*)

ANODIZED ALUMINIUM SCREWS AVAILABLE SEE PAGE 72.

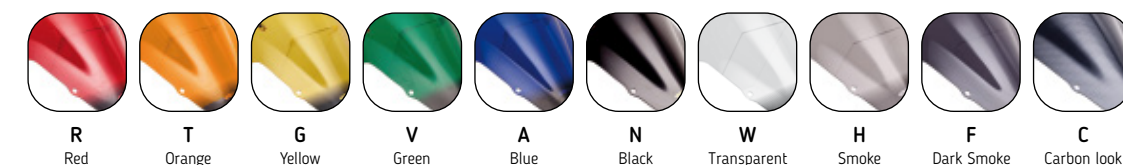

CARBON LOOK: RACING SCREEN AVAILABLE ONLY.
NOTE COLORS: N COLOR DELIVERED WITHOUT SILK PRINT.
 (*) Check price with your distributor.
 (-) Adjustable in width and height.
IMPORTANT: Indicate code color after part#. Example 0973A

WINDSCREEN MODELS

HI-TECH PARTS | TYPE OF WINDSCREEN:



STANDARD

Windscreen without supports, form and height are the same as the original windscreen.



SPORT

Windscreen without supports, lower than the original windscreen.



RACING

Doble height Windscen, it drives the air away from your helmet, for supersport bikes.

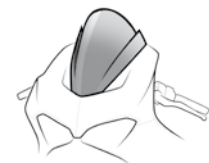

Z-RACING

Windscreen with edges in Z form that drives the air away from the helmet. Slightly taller than the original. Wide range of colors.



R-RACER

Windscreen that comes from competition, without edges. Significantly taller than the original one. Available in smoked colors.



NEW GENERATION

Windscreen with adaptor specifically designed for motorcycles that do not have a screen, especially for Naked models.

2021 MODELS: www.puig.tv

MODEL	YEAR	TYPE OF WINDSCREEN	REF.	DIMENSIONS (Height x Width)	HEIGHT (mm) Compared to OEM	THICKNESS (mm)	N H	W F	R V	T A	G C
GSX-S125	17' - 20'	NEW GENERATION	SEE PAGE 110								
GSX-S750	17' - 20'	NEW GENERATION	SEE PAGE 110								
GSX-S1000	15' - 20'	NEW GENERATION	SEE PAGE 110								
GSX-S1000F	15' - 20'	SPORT	7639	330 x 280	-160	3	(*)				(*)
GSX-S1000F	15' - 20'	TOURING	7640	590 x 325	+135	3	(*)				
GSX-S1000F	15' - 20'	TOURING SCREEN WITH VISOR BOLT-ON	7641H				(*)				
GSX-S1000F	15' - 20'	TOURING SCREEN WITH CLIP-ON VISOR	7640 + 6320				(*)				
INAZUMA	13' - 17'	NEW GENERATION	SEE PAGE 110								
INAZUMA F	15' - 17'	Z-RACING	7642	410 x 390	+75	4	(*)				
KATANA	19' - 20'	TOURING	3637	355 x 335	+110	3	(*)				(*)
KATANA	19' - 20'	TOURING SCREEN WITH VISOR BOLT-ON	3638H				(*)				
KATANA	19' - 20'	TOURING SCREEN WITH CLIP-ON VISOR	3637 + 6319				(*)				
SFV650 GLADIUS	09' - 15'	NEW GENERATION	SEE PAGE 110								
SV650S	03' - 08'	STANDARD	1344	350 x 375		3					(*)
SV650S	03' - 08'	TOURING	1346	350 x 370		3	(*)				(*)
SV1000S	03' - 05'	STANDARD	1344	350 x 375		3					(*)
SV1000S	03' - 05'	TOURING	1346	350 x 370		3	(*)				(*)
TL1000R	98' - 99'	STANDARD	0459			3	(*)				
TRIUMPH											
BONNEVILLE BOBBER	17' - 20'	NEW GENERATION	SEE PAGE 110								
DAYTONA 600	03' - 04'	RACING	1928	410 x 370		3					(*)
DAYTONA 650	05'	RACING	1928	410 x 370		3					(*)
DAYTONA 675	06' - 08'	RACING	4108	415 x 350		3	(*)				(*)
DAYTONA 675	09' - 12'	Z-RACING	4939	440 x 300		3	(*)				(*)
DAYTONA 675	13' - 17'	Z-RACING	6498	390 x 300	+30	3	(*)				(*)
DAYTONA 675 R	11' - 12'	Z-RACING	4939	440 x 300		3	(*)				(*)
DAYTONA 675 R	13' - 17'	Z-RACING	6498	390 x 300	+30	3	(*)				(*)



TOURING

Windscreen taller than the original to provide more protection to the rider.



TOURING PLUS

Windscreen larger than the Puig Touring model, for certain models of motorcycle tourer for maximum aerodynamic protection.



TOURING WITH VISOR

Higher windscreen than the original that incorporates a multi-adjustable screwed visor to divert air from the rider and provide comfort.



TOURING WITH VISOR "CLIP ON"

Higher windscreen than the original to which is assigned a multi-adjustable visor that is fixed with a system called "clip-on" to divert the air from the rider and provide maximum comfort when driving.



ADJUSTABLE

Windscreen that can be adjusted in height, with or without tools and adjust it to the most suitable position for each rider / situation..

2021 MODELS: www.puig.tv

MODEL	YEAR	TYPE OF WINDSCREEN	REF.	DIMENSIONS (Height x Width)	HEIGHT (mm) Compared to OEM	THICKNESS (mm)	N H	W F	R V	T A	G C
DAYTONA 955i	01' - 03'	RACING	1927	280 x 410		3	(*)				(*)
ROCKET 3	20'	NEW GENERATION	SEE PAGE 110								
SPEED TRIPLE	05' - 18'	NEW GENERATION	SEE PAGE 111								
SPEED TRIPLE R	12' - 18'	NEW GENERATION	SEE PAGE 111								
SPEED TRIPLE S/RS	19' - 20'	NEW GENERATION	SEE PAGE 111								
STREET TRIPLE	07' - 19'	NEW GENERATION	SEE PAGE 111								
STREET TRIPLE R	08' - 19'	NEW GENERATION	SEE PAGE 111								
STREET TRIPLE S	17' - 20'	NEW GENERATION	SEE PAGE 111								
STREET TRIPLE RS	17' - 19'	NEW GENERATION	SEE PAGE 111								
TIGER 800/ XC	11' - 14'	TOURING	5652 (-)	490 x 430	+130	3	(*)				
TIGER 800/XC	11' - 14'	TOURING SCREEN WITH VISOR BOLT-ON	5918H				(*)				
TIGER 800/XC	11' - 14'	TOURING SCREEN WITH CLIP-ON VISOR	5652 + 6320				(*)				
TIGER 800 XC/XCX/XCA	15' - 17'	TOURING	5652 (-)	490 x 430	+130	3	(*)				
TIGER 800 XC/XCX/XCA	15' - 17'	TOURING SCREEN WITH VISOR BOLT-ON	5918H				(*)				
TIGER 800 XC/XCX/XCA	15' - 17'	TOURING SCREEN WITH CLIP-ON VISOR	5652 + 6320				(*)				
TIGER 800 XR/XRX/XRT	15' - 17'	TOURING	5652 (-)	490 x 430	+130	3	(*)				
TIGER 800 XR/XRX/XRT	15' - 17'	TOURING SCREEN WITH VISOR BOLT-ON	5918H				(*)				
TIGER 800 XR/XRX/XRT	15' - 17'	TOURING SCREEN WITH CLIP-ON VISOR	5652 + 6320				(*)				
TIGER 800 XC/XCX/XCA/XR/XRX/XRT	18' - 20'	TOURING	9656	550 x 440	+115	4	(*)				
TIGER 800 XC/XCX/XCA/XR/XRX/XRT	18' - 20'	TOURING SCREEN WITH VISOR BOLT-ON	9658H				(*)				

ANODIZED ALUMINIUM SCREWS AVAILABLE SEE PAGE 72.

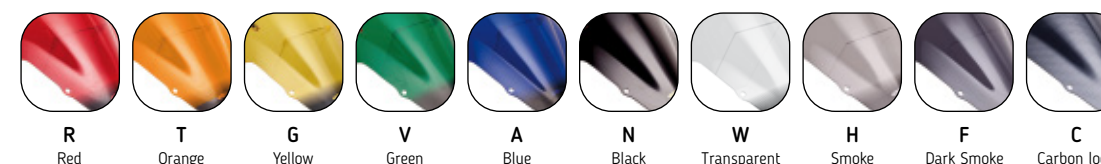

CARBON LOOK: RACING SCREEN AVAILABLE ONLY.
NOTE COLORS: N COLOR DELIVERED WITHOUT SILK PRINT.
 (*) Check price with your distributor.
 (-) Adjustable in width and height.
IMPORTANT: Indicate code color after part#. Example 0973A

WINDSCREEN MODELS

HI-TECH PARTS | TYPE OF WINDSCREEN:

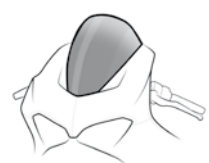

STANDARD

Windscreen without supports, form and height are the same as the original windscreen.



SPORT

Windscreen without supports, lower than the original windscreen.



RACING

Doble height Windscree, it drives the air away from your helmet, for supersport bikes.

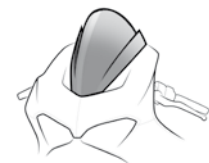

Z-RACING

Windscreen with edges in Z form that drives the air away from the helmet. Slightly taller than the original. Wide range of colors.



R-RACER

Windscreen that comes from competition, without edges. Significantly taller than the original one. Available in smoked colors.



NEW GENERATION

Windscreen with adaptor specifically designed for motorcycles that do not have a screen, especially for Naked models.



TOURING

Windscreen taller than the original to provide more protection to the rider.



TOURING PLUS

Windscreen larger than the Puig Touring model, for certain models of motorcycle tourer for maximum aerodynamic protection.



TOURING WITH VISOR

Higher windscreen than the original that incorporates a multi-adjustable screwed visor to divert air from the rider and provide comfort.



TOURING WITH VISOR "CLIP ON"

Higher windscreen than the original to which is assigned a multi-adjustable visor that is fixed with a system called "clip-on" to divert the air from the rider and provide maximum comfort when driving.



ADJUSTABLE

Windscreen that can be adjusted in height, with or without tools and adjust it to the most suitable position for each rider / situation..

2021 MODELS: www.puig.tv

MODEL	YEAR	TYPE OF WINDSCREEN	REF.	DIMENSIONS (Height x Width)	HEIGHT (mm) Compared to OEM	THICKNESS (mm)	N W H F	R T G V A C
TIGER 800 XC/XCX/XCA/XR/XRX/XRT	18' - 20'	TOURING SCREEN WITH CLIP-ON VISOR	9656 + 6375				(*)	
TIGER 900	20'	TOURING	20375	560 x 390	+60	4	(*)	
TIGER 900	20'	TOURING SCREEN WITH VISOR BOLT-ON	20376H				(*)	
TIGER 900	20'	TOURING SCREEN WITH CLIP-ON VISOR	20375 + 6320				(*)	
TIGER 900 GT	20'	TOURING	20375	560 x 390	+60	4	(*)	
TIGER 900 GT	20'	TOURING SCREEN WITH VISOR BOLT-ON	20376H				(*)	
TIGER 900 GT	20'	TOURING SCREEN WITH CLIP-ON VISOR	20375 + 6320				(*)	
TIGER 900 GT LOW	20'	TOURING	20375	560 x 390	+60	4	(*)	
TIGER 900 GT LOW	20'	TOURING SCREEN WITH VISOR BOLT-ON	20376H				(*)	
TIGER 900 GT LOW	20'	TOURING SCREEN WITH CLIP-ON VISOR	20375 + 6320				(*)	
TIGER 900 GT PRO	20'	TOURING	20375	560 x 390	+60	4	(*)	
TIGER 900 GT PRO	20'	TOURING SCREEN WITH VISOR BOLT-ON	20376H				(*)	
TIGER 900 GT PRO	20'	TOURING SCREEN WITH CLIP-ON VISOR	20375 + 6320				(*)	
TIGER 900 RALLY	20'	TOURING	20375	560 x 390	+60	4	(*)	
TIGER 900 RALLY	20'	TOURING SCREEN WITH VISOR BOLT-ON	20376H				(*)	
TIGER 900 RALLY	20'	TOURING SCREEN WITH CLIP-ON VISOR	20375 + 6320				(*)	
TIGER 900 RALLY PRO	20'	TOURING	20375	560 x 390	+60	4	(*)	
TIGER 900 RALLY PRO	20'	TOURING SCREEN WITH VISOR BOLT-ON	20376H				(*)	
TIGER 900 RALLY PRO	20'	TOURING SCREEN WITH CLIP-ON VISOR	20375 + 6320				(*)	
TIGER 1050	07' - 13'	TOURING	4359	500 x 355	+75	3	(*)	
TIGER 1050	07' - 13'	TOURING SCREEN WITH VISOR BOLT-ON	5919H				(*)	
TIGER 1050	07' - 13'	TOURING SCREEN WITH CLIP-ON VISOR	4359 + 6320				(*)	

2021 MODELS: www.puig.tv

MODEL	YEAR	TYPE OF WINDSCREEN	REF.	DIMENSIONS (Height x Width)	HEIGHT (mm) Compared to OEM	THICKNESS (mm)	N W H F	R T G V A C
TIGER EXPLORER	12' - 15'	TOURING	6000	560 x 510	+100	3	(*)	
TIGER EXPLORER	12' - 15'	TOURING SCREEN WITH VISOR BOLT-ON	6006H				(*)	
TIGER EXPLORER	12' - 15'	TOURING SCREEN WITH CLIP-ON VISOR	6000 + 6319				(*)	
TIGER EXPLORER XC	13' - 15'	TOURING	6000	560 x 510	+100	3	(*)	
TIGER EXPLORER XC	13' - 15'	TOURING SCREEN WITH VISOR BOLT-ON	6006H				(*)	
TIGER EXPLORER XC	13' - 15'	TOURING SCREEN WITH CLIP-ON VISOR	6000 + 6319				(*)	
TIGER EXPLORER XC/XR/XRX/XRT/XCX/XCA	16' - 17'	TOURING	8915	630 x 410	+90	4	(*)	
TIGER EXPLORER XC/XR/XRX/XRT/XCX/XCA	16' - 17'	TOURING SCREEN WITH VISOR BOLT-ON	8916H				(*)	
TIGER EXPLORER XC/XR/XRX/XRT/XCX/XCA	16' - 17'	TOURING SCREEN WITH CLIP-ON VISOR	8915 + 6375				(*)	
TIGER EXPLORER XC/XR/XRX/XRT/XCX/XCA	18' - 20'	TOURING	9613	620 x 495	+80	4	(*)	
TIGER EXPLORER XC/XR/XRX/XRT/XCX/XCA	18' - 20'	TOURING SCREEN WITH VISOR BOLT-ON	9614H				(*)	
TIGER EXPLORER XC/XR/XRX/XRT/XCX/XCA	18' - 20'	TOURING SCREEN WITH CLIP-ON VISOR	9613 + 6320				(*)	
TIGER SPORT	13' - 15'	TOURING	4359	500 x 355	+75	3	(*)	
TIGER SPORT	13' - 15'	TOURING SCREEN WITH VISOR BOLT-ON	5919H				(*)	
TIGER SPORT	13' - 15'	TOURING SCREEN WITH CLIP-ON VISOR	4359 + 6320				(*)	
TIGER SPORT	16' - 20'	TOURING	9200	615 x 440	+120	4	(*)	
TIGER SPORT	16' - 20'	TOURING SCREEN WITH VISOR BOLT-ON	9201H				(*)	
TIGER SPORT	16' - 20'	TOURING SCREEN WITH CLIP-ON VISOR	9200 + 6320				(*)	

ANODIZED ALUMINIUM SCREWS AVAILABLE SEE PAGE 72.

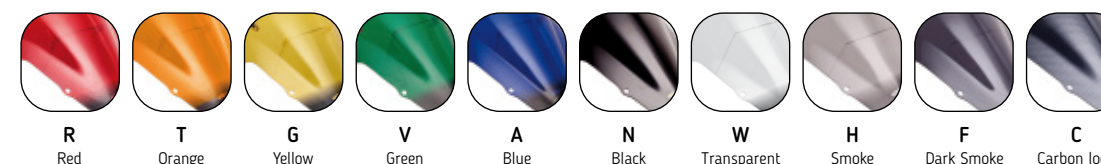

CARBON LOOK: RACING SCREEN AVAILABLE ONLY.
NOTE COLORS: N COLOR DELIVERED WITHOUT SILK PRINT.
 (*) Check price with your distributor.
 (-) Adjustable in width and height.
IMPORTANT: Indicate code color after part#. Example 0973A

WINDSCREEN MODELS

HI-TECH PARTS | TYPE OF WINDSCREEN:

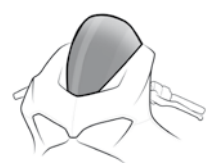

STANDARD

Windscreen without supports, form and height are the same as the original windscreen.



SPORT

Windscreen without supports, lower than the original windscreen.



RACING

Doble height Windscresn, it drives the air away from your helmet, for supersport bikes.

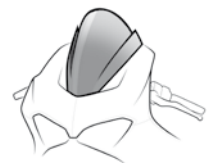

Z-RACING

Windscreen with edges in Z form that drives the air away from the helmet. Slightly taller than the original. Wide range of colors.



R-RACER

Windscreen that comes from competition, without edges. Significantly taller than the original one. Available in smoked colors.

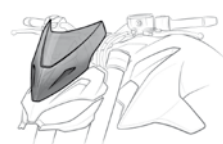

NEW GENERATION

Windscreen with adaptor specifically designed for motorcycles that do not have a screen, especially for Naked models.



TOURING

Windscreen taller than the original to provide more protection to the rider.



TOURING PLUS

Windscreen larger than the Puig Touring model, for certain models of motorcycle tourer for maximum aerodynamic protection.



TOURING WITH VISOR

Higher windscreen than the original that incorporates a multi-adjustable screwed visor to divert air from the rider and provide comfort.



TOURING WITH VISOR "CLIP ON"

Higher windscreen than the original which is assigned a multi-adjustable visor that is fixed with a system called "clip-on" to divert the air from the rider and provide maximum comfort when driving.



ADJUSTABLE

Windscreen that can be adjusted in height, with or without tools and adjust it to the most suitable position for each rider / situation..

2021 MODELS: www.puig.tv

MODEL	YEAR	TYPE OF WINDSCREEN	REF.	DIMENSIONS (Height x Width)	HEIGHT (mm) Compared to OEM	THICKNESS (mm)	N W H F	R T G V A C
YAMAHA								
FAZER8	13' - 16'	Z-RACING	5572	430 x 330	+105	3	(*)	
FJR1300	01' - 05'	TOURING	1281	540 x 520	+130	4	(*)	(*)
FJR1300A/AS	06' - 12'	TOURING	4103	500 x 505	+35	4	(*)	(*)
FJR1300A/AS	13' - 20'	TOURING	6483	560 x 570	+90	4	(*)	
FJR1300A/AS	13' - 20'	TOURING SCREEN WITH VISOR BOLT-ON	6501H				(*)	
FJR1300A/AS	13' - 20'	TOURING SCREEN WITH CLIP-ON VISOR	6483 + 6375				(*)	
FZ1	06' - 15'	NEW GENERATION	SEE PAGE 111					
FZ1 FAZER	06' - 15'	RACING	4061	410 x 300		3	(*)	(*)
FZ1 FAZER	06' - 15'	TOURING	4101	480 x 420	+100	3	(*)	(*)
FZ1 FAZER	06' - 15'	TOURING SCREEN WITH VISOR BOLT-ON	5907H				(*)	
FZ1 FAZER	06' - 15'	TOURING SCREEN WITH CLIP-ON VISOR	4101 + 6320				(*)	(*)
FZ6	04' - 08'	NEW GENERATION	SEE PAGE 111					
FZ6 S2	07' - 10'	NEW GENERATION	SEE PAGE 111					
FZ6 FAZER	04' - 08'	RACING	1646	550 x 570		3	(*)	(*)
FZ6 FAZER	04' - 08'	TOURING	1647	590 x 540	+90	3	(*)	
FZ6 FAZER S2	07' - 10'	RACING	4366	420 x 330		3	(*)	(*)
FZ6 FAZER S2	07' - 10'	TOURING	4367	475 x 335	+100	3	(*)	(*)
FZ6 FAZER S2	07' - 10'	TOURING SCREEN WITH VISOR BOLT-ON	5908H				(*)	
FZ6 FAZER S2	07' - 10'	TOURING SCREEN WITH CLIP-ON VISOR	4367 + 6320				(*)	(*)
FZ8	10' - 16'	NEW GENERATION	SEE PAGE 111					
FZ8 FAZER	10' - 12'	Z-RACING	5572	430 x 330	+105	3	(*)	
FZS600 FAZER	02' - 03'	TOURING	1111	455 x 330	+90	3		(*)
MT-125	14' - 20'	NEW GENERATION	SEE PAGE 111					
MT-03	16' - 20'	NEW GENERATION	SEE PAGE 111					
MT-07	14' - 20'	NEW GENERATION	SEE PAGE 111					

2021 MODELS: www.puig.tv

MODEL	YEAR	TYPE OF WINDSCREEN	REF.	DIMENSIONS (Height x Width)	HEIGHT (mm) Compared to OEM	THICKNESS (mm)	N W H F	R T G V A C
MT-07 TRACER	16' - 19*	Z-RACING	9211	406 x 290	-50	4	(*)	
MT-07 TRACER	16' - 19'	TOURING	9212	600 x 360	+150	4	(*)	
MT-07 TRACER	16' - 19'	TOURING SCREEN WITH VISOR BOLT-ON	9213H				(*)	
MT-07 TRACER	16' - 19'	TOURING SCREEN WITH CLIP-ON VISOR	9212 + 6375				(*)	
MT-07 TRACER	20'	SPORT	20433	382 x 250	+0	4	(*)	
MT-07 TRACER	20'	TOURING	20434	583 x 375	+150	4	(*)	
MT-07 TRACER	20'	TOURING SCREEN WITH VISOR BOLT-ON	20435				(*)	
MT-07 TRACER	20'	TOURING SCREEN WITH CLIP-ON VISOR	20434 + 6375				(*)	
MT-07 TRACER GT	19'	Z-RACING	9211	406 x 290	-50	4	(*)	
MT-07 TRACER GT	19'	TOURING	9212	600 x 360	+150	4	(*)	
MT-07 TRACER GT	19'	TOURING SCREEN WITH VISOR BOLT-ON	9213H				(*)	
MT-07 TRACER GT	19'	TOURING SCREEN WITH CLIP-ON VISOR	9212 + 6375				(*)	
MT-09	13' - 20'	NEW GENERATION	SEE PAGE 111					
MT-09 SP	18' - 20'	NEW GENERATION	SEE PAGE 111					
MT-09 TRACER	15' - 17'	SPORT	7645	390 x 290	-60	3	(*)	(*)
MT-09 TRACER	15' - 17'	TOURING	7646	640 x 405	+160	3	(*)	
MT-09 TRACER	18' - 20'	SPORT	9724	376 x 287	-140	4	(*)	
MT-09 TRACER	18' - 20'	TOURING	9725	645 x 445	+105	4	(*)	
MT-09 TRACER	18' - 20'	TOURING SCREEN WITH VISOR BOLT-ON	9726H				(*)	
MT-09 TRACER	18' - 20'	TOURING SCREEN WITH CLIP-ON VISOR	9725 + 6375				(*)	

ANODIZED ALUMINIUM SCREWS AVAILABLE SEE PAGE 72.

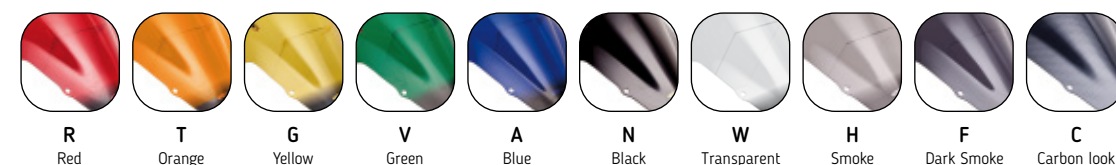

CARBON LOOK: RACING SCREEN AVAILABLE ONLY.
NOTE COLORS: N COLOR DELIVERED WITHOUT SILK PRINT.
 (*) Check price with your distributor.
 (-) Adjustable in width and height.
IMPORTANT: Indicate code color after part#. Example 0973A

WINDSCREEN MODELS

HI-TECH PARTS | TYPE OF WINDSCREEN:



STANDARD

Windscreen without supports, form and height are the same as the original windscreen.



SPORT

Windscreen without supports, lower than the original windscreen.



RACING

Doble height Windscreen, it drives the air away from your helmet, for supersport bikes.



Z-RACING

Windscreen with edges in Z form that drives the air away from the helmet. Slightly taller than the original. Wide range of colors.



R-RACER

Windscreen that comes from competition, without edges. Significantly taller than the original one. Available in smoked colors.



NEW GENERATION

Windscreen with adaptor specifically designed for motorcycles that do not have a screen, especially for Naked models.



TOURING

Windscreen taller than the original to provide more protection to the rider.



TOURING PLUS

Windscreen larger than the Puig Touring model, for certain models of motorcycle tourer for maximum aerodynamic protection.



TOURING WITH VISOR

Higher windscreen than the original that incorporates a multi-adjustable screwed visor to divert air from the rider and provide comfort.



TOURING WITH VISOR "CLIP ON"

Higher windscreen than the original to which is assigned a multi-adjustable visor that is fixed with a system called "clip-on" to divert the air from the rider and provide maximum comfort when driving.



ADJUSTABLE

Windscreen that can be adjusted in height, with or without tools and adjust it to the most suitable position for each rider / situation..

2021 MODELS: www.puig.tv

MODEL	YEAR	TYPE OF WINDSCREEN	REF.	DIMENSIONS (Height x Width)	HEIGHT (mm) Compared to OEM	THICKNESS (mm)	N W H F	R T G V A C
MT-09 TRACER GT	18' - 20'	SPORT	9724	376 x 287	-140	4	(*)	
MT-09 TRACER GT	18' - 20'	TOURING	9725	645 x 445	+105	4	(*)	
MT-09 TRACER GT	18' - 20'	TOURING SCREEN WITH VISOR BOLT-ON	9726H				(*)	
MT-09 TRACER GT	18' - 20'	TOURING SCREEN WITH CLIP-ON VISOR	9725 + 6375				(*)	
MT-10	16' - 20'	TOURING	8917	365 x 325	+70	3	(*)	(*)
MT-10	16' - 20'	TOURING PLUS	8918	540 x 360	+225	4	(*)	(*)
MT-10	16' - 20'	TOURING PLUS SCREEN WITH VISOR BOLT-ON	8919H				(*)	
MT-10	16' - 20'	TOURING PLUS SCREEN WITH CLIP-ON VISOR	8918 + 6320				(*)	
MT-10 SP	17' - 20'	TOURING	8917	365 x 325	+70	3	(*)	(*)
MT-10 SP	17' - 20'	TOURING PLUS	8918	540 x 360	+225	4	(*)	(*)
MT-10 SP	17' - 20'	TOURING PLUS SCREEN WITH VISOR BOLT-ON	8919H				(*)	
MT-10 SP	17' - 20'	TOURING PLUS SCREEN WITH CLIP-ON VISOR	8918 + 6320				(*)	
NIKEN	18' - 20'	TOURING	2385	608 x 490	+300	4	(*)	
NIKEN	18' - 20'	TOURING SCREEN WITH VISOR BOLT-ON	3535H				(*)	
NIKEN	18' - 20'	TOURING SCREEN WITH CLIP-ON VISOR	2385 + 6320				(*)	
TENERE 700	19' - 20'	TOURING	3727	415 x 310	+80	3	(*)	
TENERE 700	19' - 20'	TOURING SCREEN WITH VISOR BOLT-ON	3728H				(*)	
TENERE 700	19' - 20'	TOURING SCREEN WITH CLIP-ON VISOR	3727 + 6319				(*)	
TDM 900	02' - 13'	STANDARD	1106			3	(*)	
TZR50	03' - 16'	STANDARD	1596	365 x 300		3		(*)
VMAX	09' - 16'	NEW GENERATION	SEE PAGE 111					
XJ6	09' - 16'	NEW GENERATION	SEE PAGE 111					
XJ6 DIVERSION	09' - 16'	TOURING	4938	505 x 415	+150	3	(*)	

2021 MODELS: www.puig.tv

MODEL	YEAR	TYPE OF WINDSCREEN	REF.	DIMENSIONS (Height x Width)	HEIGHT (mm) Compared to OEM	THICKNESS (mm)	N W H F	R T G V A C
XJ6 DIVERSION	09' - 16'	TOURING SCREEN WITH VISOR BOLT-ON	5909H				(*)	
XJ6 DIVERSION	09' - 16'	TOURING SCREEN WITH CLIP-ON VISOR	4938 + 6375				(*)	
XJ6 DIVERSION F	10' - 16'	TOURING	5547	390 x 260		3	(*)	(*)
XJ6 DIVERSION F	10' - 16'	TOURING PLUS	5548	500 x 360	+130	3	(*)	
XJ6 DIVERSION F	10' - 16'	TOURING PLUS SCREEN WITH VISOR BOLT-ON	5910H				(*)	
XJ6 DIVERSION F	10' - 16'	TOURING PLUS SCREEN WITH CLIP-ON VISOR	5548 + 6320				(*)	
XT660X	07' - 16'	NEW GENERATION	SEE PAGE 111					
XT660Z TÉNÉRÉ	08' - 16'	TOURING	4636	385 x 470	+80	3	(*)	(*)
XT660Z TÉNÉRÉ	08' - 16'	TOURING SCREEN WITH VISOR BOLT-ON	5912H				(*)	
XT660Z TÉNÉRÉ	08' - 16'	TOURING SCREEN WITH CLIP-ON VISOR	4636 + 6319				(*)	(*)
XT1200Z SUPER TÉNÉRÉ	10' - 13'	TOURING	5568	505 x 450	+80	3	(*)	
XT1200Z SUPER TÉNÉRÉ	10' - 13'	TOURING SCREEN WITH VISOR BOLT-ON	5911H				(*)	
XT1200Z SUPER TÉNÉRÉ	10' - 13'	TOURING SCREEN WITH CLIP-ON VISOR	5568 + 6375				(*)	
XT1200Z SUPER TÉNÉRÉ	14' - 20'	TOURING	7541	600 x 465	+140	4	(*)	
XT1200Z SUPER TÉNÉRÉ	14' - 20'	TOURING SCREEN WITH VISOR BOLT-ON	7600H				(*)	
XT1200Z SUPER TÉNÉRÉ	14' - 20'	TOURING SCREEN WITH CLIP-ON VISOR	7541 + 6320				(*)	
XV950/R	14' - 20'	NEW GENERATION	SEE PAGE 111					
XV950 RACER	14' - 20'	NEW GENERATION	SEE PAGE 111					
YZF 600 R THUNDERCAT	96' - 02'	STANDARD	0594			3	(*)	

ANODIZED ALUMINIUM SCREWS AVAILABLE SEE PAGE 72.

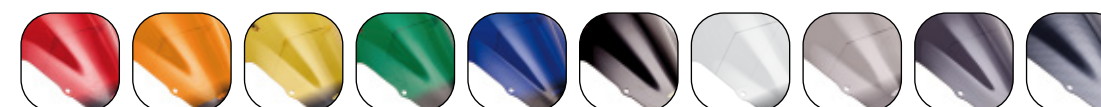

R Red T Orange G Yellow V Green A Blue N Black W Transparent H Smoke F Dark Smoke C Carbon look

CARBON LOOK: RACING SCREEN AVAILABLE ONLY.
NOTE COLORS: N COLOR DELIVERED WITHOUT SILK PRINT.

(*) Check price with your distributor.

(-) Adjustable in width and height.

IMPORTANT: Indicate code color after part#. Example 0973A

WINDSCREEN MODELS

HI-TECH PARTS | TYPE OF WINDSCREEN:

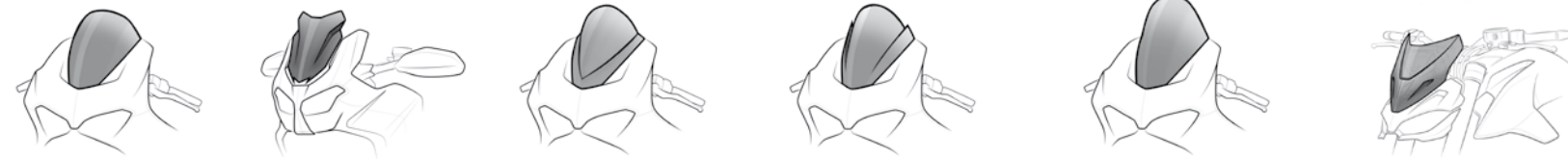

- STANDARD**
Windscreen without supports, form and height are the same as the original windscreen.
- SPORT**
Windscreen without supports, lower than the original windscreen.
- RACING**
Doble height Windscreen, it drives the air away from your helmet, for supersport bikes.
- Z-RACING**
Windscreen with edges in Z form that drives the air away from the helmet. Slightly taller than the original. Wide range of colors.
- R-RACER**
Windscreen that comes from competition, without edges. Significantly taller than the original one. Available in smoked colors.
- NEW GENERATION**
Windscreen with adaptor specifically designed for motorcycles that do not have a screen, especially for Naked models.



- TOURING**
Windscreen taller than the original to provide more protection to the rider.
- TOURING PLUS**
Windscreen larger than the Puig Touring model, for certain models of motorcycle tourer for maximum aerodynamic protection.
- TOURING WITH VISOR**
Higher windscreen than the original that incorporates a multi-adjustable screwed visor to divert air from the rider and provide comfort.
- TOURING WITH VISOR "CLIP ON"**
Higher windscreen than the original to which is assigned a multi-adjustable visor that is fixed with a system called "clip-on" to divert the air from the rider and provide maximum comfort when driving.
- ADJUSTABLE**
Windscreen that can be adjusted in height, with or without tools and adjust it to the most suitable position for each rider / situation..

2021 MODELS: www.puig.tv

MODEL	YEAR	TYPE OF WINDSCREEN	REF.	DIMENSIONS (Height x Width)	HEIGHT (mm) Compared to OEM	THICKNESS (mm)	N H	W F	R V	T A	G C
YZF 600 R THUNDERCAT	96' - 02'	RACING	1124	330 x 390		3					(*)
YZF-R125	08' - 18'	RACING	4637	370 x 255	+45	3	(*)				(*)
YZF-R125	19' - 20'	Z-RACING	3619	330 x 310	+35	3	(*)				(*)
YZF-R1	02' - 03'	RACING	1145	415 x 300		3	(*)				(*)
YZF-R1	04' - 05'	STANDARD	1649			3	(*)				
YZF-R1	04' - 06'	RACING	1650	480 x 330		3	(*)				(*)
YZF-R1 SP	06'	STANDARD	1649			3	(*)				
YZF-R1	07' - 08'	STANDARD	4364	450 x 380		3					(*)
YZF-R1	07' - 08'	RACING	4365	420 x 350		3	(*)				(*)
YZF-R1	09' - 14'	STANDARD	4934	440 x 380		3	(*)				
YZF-R1	09' - 14'	Z-RACING	4935	450 x 360		3	(*)				(*)
YZF-R1	15' - 19'	Z-RACING	7648	335 x 290	+30	3	(*)				(*)
YZF-R1	15' - 19'	R-RACER	3632	365 x 305	+245	3	(*)				
YZF-R1	20'	Z-RACING	3826	335 x 295	+30	3	(*)				(*)
YZF-R1	20'	R-RACER	3827	335 x 298	+70	3	(*)				
YZF-R1M	17' - 19'	Z-RACING	7648	335 x 290		3	(*)				(*)
YZF-R1M	17' - 19'	R-RACER	3632	365 x 305	+245	3	(*)				
YZF-R1M	20'	Z-RACING	3826	335 x 295	+30	3	(*)				(*)
YZF-R1M	20'	R-RACER	3827	335 x 298	+70	3	(*)				
YZF-R3	15' - 18'	Z-RACING	7649	300 x 295	+30	3	(*)				(*)
YZF-R3	19' - 20'	R-RACER	3737	330 x 280	+185	3	(*)				
YZF-R6	99' - 02'	RACING	0021	310 x 360		3					
YZF-R6	99' - 02'	TOURING	0626	360 x 350	+3	3	(*)				(*)
YZF-R6	03' - 05'	RACING	1328	450 x 380		3	(*)				(*)
YZF-R6	06' - 07'	STANDARD	4058	345 x 345		3					(*)
YZF-R6	06' - 07'	RACING	4059	320 x 370		3	(*)				(*)
YZF-R6	08' - 16'	STANDARD	4634			3	(*)				
YZF-R6	08' - 16'	Z-RACING	4635	350 x 370		3	(*)				(*)
YZF-R6	17' - 20'	Z-RACING	9723	360 x 285	+30	3	(*)				(*)

2021 MODELS: www.puig.tv

MODEL	YEAR	TYPE OF WINDSCREEN	REF.	DIMENSIONS (Height x Width)	HEIGHT (mm) Compared to OEM	THICKNESS (mm)	N H	W F	R V	T A	G C
YZF-R6	17' - 20'	R-RACER	3633	370 x 280	+40	3	(*)				

ANODIZED ALUMINIUM SCREWS AVAILABLE SEE PAGE 72.

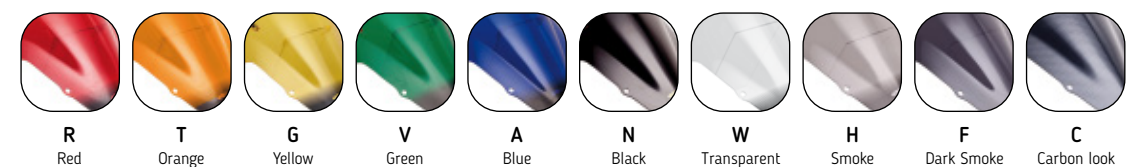

CARBON LOOK: RACING SCREEN AVAILABLE ONLY.
NOTE COLORS: N COLOR DELIVERED WITHOUT SILK PRINT.
 (*) Check price with your distributor.
 (-) Adjustable in width and height.
IMPORTANT: Indicate code color after part#. Example 0973A

SCREWS
HI-TECH PARTS

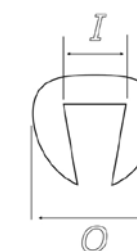
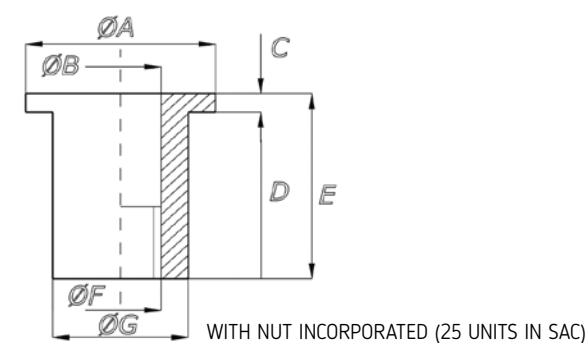

// SCREEN SCREWS

MODEL	REF.	
BLISTER 8 SCREWS M5 WITH NUTS	0956	(*)
BLISTER 8 SCREWS M5 WITH SILENTBLOCKS	0957	(*)

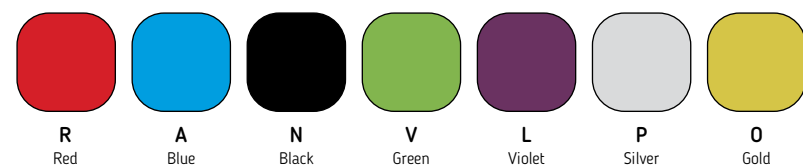

IMPORTANT: Indicate code color after part#. Example: 0973A.

// ANODIZED SCREWS KIT

MODEL	REF.	
BLISTER 6 ALLEN HEAD SCREWS M5 x 15 mm.	0543	(*)
BLISTER 6 ALLEN HEAD SCREWS M5 x 20 mm.	0550	(*)
BLISTER 6 ALLEN HEAD SCREWS M5 x 25 mm.	0610	(*)
BLISTER 6 ALLEN HEAD SCREWS M6 x 15 mm.	0611	(*)
BLISTER 6 ALLEN HEAD SCREWS M5 x 20 mm.	0657	(*)
BLISTER 6 ALLEN HEAD SCREWS M6 x 25 mm.	0689	(*)

// WELLNUTS

AxBxCxDxExG	REF.	PRICE
14 x 6 x 1,5 x 13,5 x 15 x 10 M5	0714N	(*)
15 x 7 x 1,5 x 13,5 x 15 x 12,5 M6	0715N	(*)
14 x 5 x 1,5 x 11,5 x 13 x 10 M4	1887N	(*)

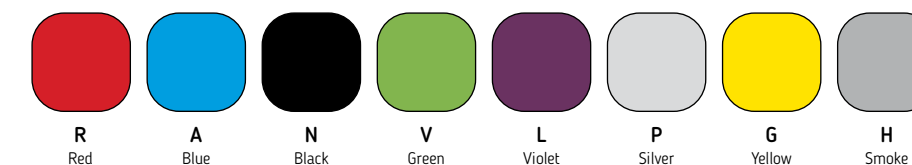

IMPORTANT: Indicate code color after part#. Example: 0973A.

// TRIM-ENDING

O x I	COLOR	REF.	ROLL	PRICE
6,2 x 2,6	TRANSPARENT	0900W	250 mts.	(*)
6,2 x 2,6	SMOKE	0900H	250 mts.	(*)
6,2 x 2,6	TRANSPARENT	5843W	2 mts.	(*)
6,2 x 2,6	SMOKE	5843H	2 mts.	(*)

M.E.M.

HI-TECH PARTS | TECHNICAL SECTION

// M.E.M.

(Manual Regulable System)

Compact mechanism that allows you to modify the position of the screen of your motorcycle without tools so you can adapt to the different situations that the route demands, raising it and increasing the aerodynamic protection on fast roads or adverse weather conditions, or reducing it in city or offroad driving for a wide field of view without interference, or for a more sport look.

You will be able to activate the mechanism and place the screen in the position you want with a quick and easy twist on the fixings, and fix it again with just your hands, without the need for tools. The mechanism is used for your OEM screen or for Puig screens for your motorcycle.



LOWEST POSITION



HIGHEST POSITION



MECHANISM
REF. 9955N



MECHANISM
REF. 9955N



MECHANISM
REF. 20504N



Aerodynamic tests supplied along with most of our windscreens.

MODEL	YEAR	REF.	Ⓜ
CRF1000L AFRICA TWIN	16' - 19'	3493N (#)	(*)
CRF1000L AFRICA TWIN	16' - 19'	9154N (#)	(*)
CRF1000L AFRICA TWIN ADVENTURE SPORTS	18' - 19'	3493N (#)	(*)
CRF1000L AFRICA TWIN ADVENTURE SPORTS	18' - 19'	9154N (#)	(*)
MT-09	17' - 20'	9955N (-)	(*)
MT-09 SP	18' - 20'	9955N (-)	(*)
TENERE 700	19' - 20'	3732N (#)	(*)

(#) Compatible with Puig and OEM screen.

(-) Compatible only with Puig screen Ref.9955

(*) Check price with your distributor.

IMPORTANT: Indicate code color after part#. Example: 0973A.

E.R.S.

HI-TECH PARTS | TECHNICAL SECTION

// E.R.S.
(Electronic Regulable System)

Electronic mechanism, easy assembly, which allows the movement of the screen easily by operating a commutator even piloting the motorcycle.

It has a height of 150 mm. To regulate at will of pilot, according to his height and the meteorological conditions.

Improves pilot comfort.

It can be mounted with both the Puig dome and the original one.

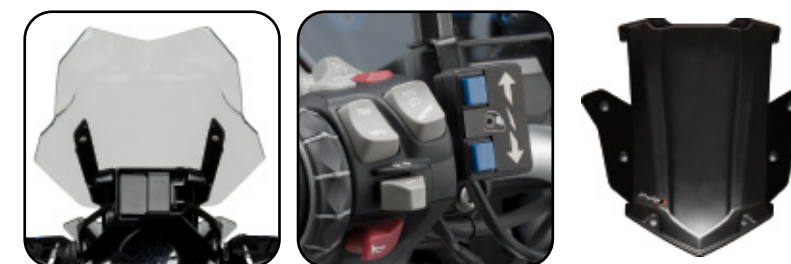

AUTOMATIC

PLUG & PLAY

MECHANISM



LOWEST POSITION



HIGHEST POSITION

MODEL	YEAR	REF.	N
BMW			
F750GS	18' - 20'	3157N	(*)
F850GS	18' - 20'	3157N	(*)
F850GS ADVENTURE	19' - 20'	3689N	(*)
R1200GS	13' - 18'	9718N	(*)
R1200GS ADVENTURE	14' - 18'	9718N	(*)
R1200GS EXCLUSIVE	17' - 18'	9718N	(*)
R1200GS RALLYE	17' - 18'	9718N	(*)
R1250GS	18' - 20'	9718N	(*)
R1250GS HP	18' - 20'	9718N	(*)
R1250GS ADVENTURE	18' - 20'	9718N	(*)
KAWASAKI			
VERSYS 1000 SE	19' - 20'	3653N	(*)
VERSYS 1000 TOURER	19' - 20'	3653N	(*)
VERSYS 1000 GRAND TOURER	19' - 20'	3653N	(*)
VERSYS 1000 TOURER PLUS	19' - 20'	3653N	(*)
SUZUKI			
DL1000XT V-STROM	17' - 20'	3174N	(*)
TRIUMPH			
TIGER 800 XC/XCX/XCA/XR/XRX/XRT	18' - 20'	3654N	(*)
YAMAHA			
MT-09 TRACER	18' - 20'	3622N	(*)
MT-09 TRACER GT	18' - 20'	3622N	(*)
XT1200Z SUPER TÉNÉRÉ	10' - 20'	3655N	(*)

(*) Check price with your distributor.

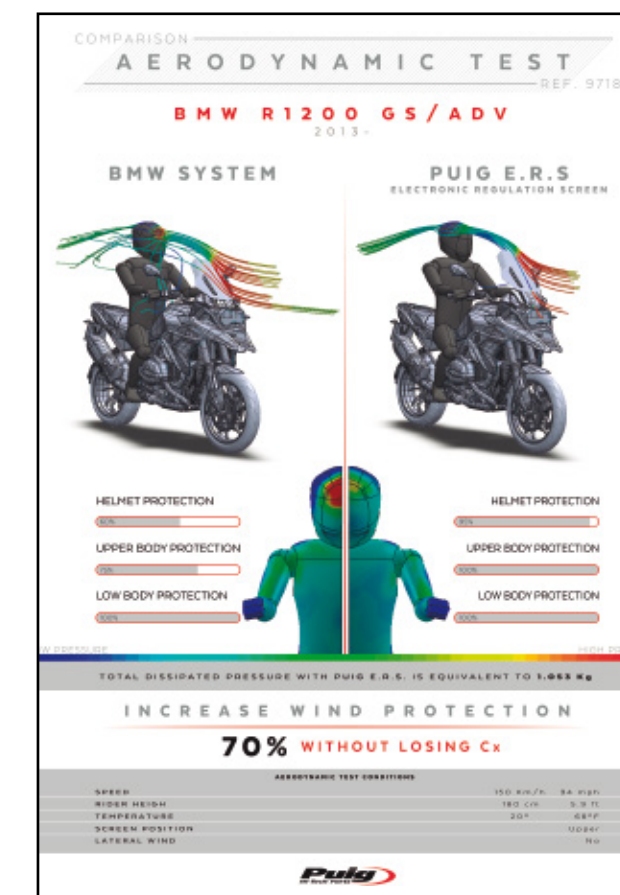

Aerodynamic tests supplied along with most of our windscreens.

WINDSHIELDS FOR MAXISCOOTERS

HI-TECH PARTS | TECHNICAL SECTION

// SCREEN TESTED IN THE VIRTUAL WIND TUNNEL

The V-Tech design has been developed through our Virtual Wind Tunnel to improve and OEM aerodynamic penetration.

Its angulated shapes on its central and side sections eases the wind canalization redirecting it to both sides of the rider, minimizing turbulences and keeping the radical look of the pieces.



PUIG



OEM

Improved aerodynamics and wind protection on average +24%.

REF.1666



PUIG

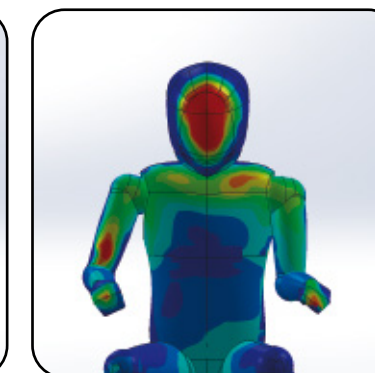

OEM

Wind pressure comparison between V-Tech Line Puig and OEM.



CHECK COMPARATIVE STUDIES FOR ALL OUR V-TECH LINE SCREENS IN OUR WEBSITE.

WINDSHIELDS FOR MAXISCOOTERS

HI-TECH PARTS | TYPE OF WINDSCREEN:

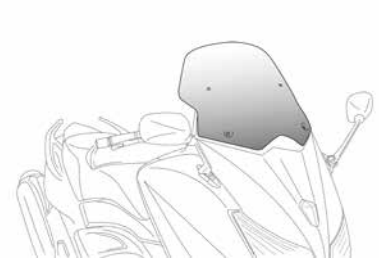

V-TECH LINE SPORT

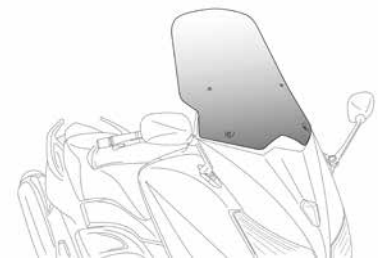

V-TECH LINE TOURING

2021 MODELS: www.puig.tv

MODEL	YEAR	TYPE DE V-TECH LINE	REF.	DIMENSIONS (Height x Width)	HEIGHT (mm) Compared to OEM	THICKNESS (mm)	N W H F
BMW							
C600 SPORT	12' - 15'	V-TECH LINE SPORT	6031	600 x 410	-50	4	(*)
C600 SPORT	12' - 15'	V-TECH LINE TOURING	9015	715 x 465	+ 70	4	(*)
C650 SPORT	16' - 20'	V-TECH LINE SPORT	9014	580 x 415	-70	4	(*)
C650 SPORT	16' - 20'	V-TECH LINE TOURING	9015	700 x 470	+110	4	(*)
C EVOLUTION	15' - 20'	V-TECH LINE TOURING	1769	915 x 810	+415	4	(*)
HONDA							
FORZA 125	15' - 17'	V-TECH LINE TOURING	7662	590 x 410	+115	4	(*)
FORZA 125	18' - 20'	V-TECH LINE TOURING	1295	590 x 410	+115	4	(*)
FORZA 300	18' - 20'	V-TECH LINE TOURING	1295	590 x 410	+115	4	(*)
INTEGRA 700	12' - 13'	V-TECH LINE SPORT	6283	510 x 370	-90	4	(*)
INTEGRA 700	12' - 13'	V-TECH LINE TOURING	6035	645 x 445	+60	4	(*)
INTEGRA 750	14' - 20'	V-TECH LINE SPORT	6283	510 x 370	-90	4	(*)
INTEGRA 750	14' - 20'	V-TECH LINE TOURING	6035	645 x 445	+60	4	(*)
INTEGRA 750S	14' - 16'	V-TECH LINE TOURING	6035	645 x 445	+60	4	(*)
PCX 125	10' - 13'	V-TECH LINE TOURING	5569	530 x 360	+140	4	(*)
PCX 125	14' - 17'	V-TECH LINE TOURING	7549	700 x 500	+260	4	(*)
PCX 125	18' - 20'	V-TECH LINE TOURING	9789	850 x 640	+400	4	(*)
PCX 150	18' - 20'	V-TECH LINE TOURING	9789	850 x 640	+400	4	(*)
KAWASAKI							
J125	16' - 20'	V-TECH LINE TOURING	7020	740 x 575	+185	4	(*)
J300	14' - 20'	V-TECH LINE TOURING	7020	740 x 575	+185	4	(*)
KEEWAY							
CITYBLADE 125	13' - 20'	V-TECH LINE TOURING	8167	615 X 350	275	4	(*)
KYMCO							
AK550	17' - 20'	V-TECH LINE SPORT	9478	555 x 395	+60	4	(*)
AK550	17' - 20'	V-TECH LINE TOURING	9477	800 x 645	-185	4	(*)
DOWNTOWN 125i	09' - 14'	V-TECH LINE SPORT	5522	540 x 460	-120	4	(*)
DOWNTOWN 125i	09' - 14'	V-TECH LINE TOURING	6790	750 x 615	+130	4	(*)
DOWNTOWN 300i	09' - 14'	V-TECH LINE SPORT	5522	540 x 460	-120	4	(*)
DOWNTOWN 300i	09' - 14'	V-TECH LINE TOURING	6790	750 x 615	+130	4	(*)

2021 MODELS: www.puig.tv

MODEL	YEAR	TYPE DE V-TECH LINE	REF.	DIMENSIONS (Height x Width)	HEIGHT (mm) Compared to OEM	THICKNESS (mm)	N W H F
GRAND DINK 125	16' - 20'	V-TECH LINE SPORT	5522	540 x 460	-120	4	(*)
GRAND DINK 125	16' - 20'	V-TECH LINE TOURING	6790	750 x 615	+130	4	(*)
GRAND DINK 300	16' - 20'	V-TECH LINE SPORT	5522	540 x 460	-120	4	(*)
GRAND DINK 300	16' - 20'	V-TECH LINE TOURING	6790	750 x 615	+130	4	(*)
G-DINK 50	12' - 18'	V-TECH LINE TOURING	6728	700 x 520	+200	4	(*)
G-DINK 125i	12' - 18'	V-TECH LINE TOURING	6728	700 x 520	+200	4	(*)
G-DINK 300i	12' - 18'	V-TECH LINE TOURING	6728	700 x 520	+200	4	(*)
G-DINK 300i	19' - 20'	V-TECH LINE TOURING	9864	750 x 620	+100	4	(*)
K-XCT 125i	13' - 16'	V-TECH LINE TOURING	6810	790 x 520	+180	4	(*)
K-XCT 300i	13' - 16'	V-TECH LINE TOURING	6810	790 x 520	+180	4	(*)
SUPERDINK 125i	09' - 14'	V-TECH LINE SPORT	5522	540 x 460	-120	4	(*)
SUPERDINK 125i	09' - 14'	V-TECH LINE TOURING	6790	750 x 615	+130	4	(*)
SUPERDINK 300i	09' - 14'	V-TECH LINE SPORT	5522	540 x 460	-120	4	(*)
SUPERDINK 300i	09' - 14'	V-TECH LINE TOURING	6790	750 x 615	+130	4	(*)
SUPERDINK 350i	09' - 14'	V-TECH LINE SPORT	5522	540 x 460	-120	4	(*)
SUPERDINK 350i	09' - 14'	V-TECH LINE TOURING	6790	750 x 615	+130	4	(*)
XCITING 400i	14' - 16'	V-TECH LINE TOURING	6034	745 x 585	+165	4	(*)
XCITING 400i	17' - 20'	V-TECH LINE TOURING	9864	750 x 620	+100	4	(*)
XCITING S 400	19' - 20'	V-TECH LINE TOURING	3757	795 x 759	+155	4	(*)
XCITING 500i	07' - 13'	V-TECH LINE SPORT	5271	605 x 360	+0	4	(*)
X-TOWN 125	16' - 20'	V-TECH LINE SPORT	5522	540 x 460	-120	4	(*)
X-TOWN 125	16' - 20'	V-TECH LINE TOURING	6790	750 x 615	+130	4	(*)
X-TOWN 300	16' - 20'	V-TECH LINE SPORT	5522	540 x 460	-120	4	(*)
X-TOWN 300	16' - 20'	V-TECH LINE TOURING	6790	750 x 615	+130	4	(*)
YAGER GT 125i	13' - 18'	V-TECH LINE TOURING	6728	700 x 520	+200	4	(*)
YAGER GT 300i	13' - 18'	V-TECH LINE TOURING	6728	700 x 520	+200	4	(*)
MBK							
EVOLIS 125	10' - 20'	V-TECH LINE TOURING	6259	560 x 430	+125	4	(*)
EVOLIS 250	10' - 20'	V-TECH LINE TOURING	6259	560 x 430	+125	4	(*)
EVOLIS 400	13' - 20'	V-TECH LINE SPORT	7503	365 x 370	-155	4	(*)
EVOLIS 400	13' - 20'	V-TECH LINE TOURING	6874	660 x 540	+140	4	(*)
PIAGGIO							
MP3 350	18' - 20'	V-TECH LINE TOURING	1666	825 x 655	+150	4	(*)
MP3 500 HPE ABS ASR	18' - 20'	V-TECH LINE TOURING	1666	825 x 655	+150	4	(*)
MP3 500 HPE BUSINESS ABS ASR	18' - 20'	V-TECH LINE TOURING	1666	825 x 655	+150	4	(*)
SUZUKI							
BURGMAN 125	14' - 20'	V-TECH LINE TOURING	7019	735 x 560	+190	4	(*)
BURGMAN 200	14' - 20'	V-TECH LINE TOURING	7019	735 x 560	+190	4	(*)



(*) Check price with your distributor.

IMPORTANT: Indicate code color after part#. Example 0973A

WINDSHIELDS FOR MAXISCOOTERS

HI-TECH PARTS | TYPE OF WINDSCREEN:

TÜV

ABE
38120

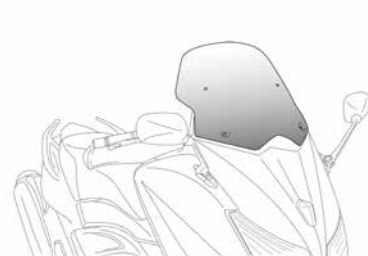

V-TECH LINE SPORT

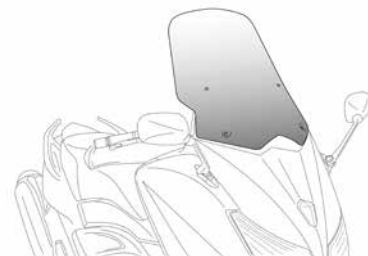

V-TECH LINE TOURING

2021 MODELS: www.puig.tv

MODEL	YEAR	TYPE DE V-TECH LINE	REF.	DIMENSIONS (Height x Width)	HEIGHT (mm) Compared to OEM	THICKNESS (mm)	N W H F
BURGMAN 400	17' - 20'	V-TECH LINE TOURING	9973	760 x 595	+220	4	(*)
BURGMAN 650/ EXECUTIVE	13' - 20'	V-TECH LINE TOURING	7309	770 x 530	+110	4	(*)
YAMAHA							
NMAX 125	15' - 20'	V-TECH LINE TOURING	8121	740 x 385	+350	4	(*)
MAJESTY 125 S	15' - 16'	V-TECH LINE TOURING	7665	605 x 510	+130	4	(*)
S-MAX	15' - 16'	V-TECH LINE TOURING	7665	605 x 510	+130	4	(*)
T-MAX 500	08' - 11'	V-TECH LINE SPORT	5031	650 x 450	-190	4	(*)
T-MAX 530	12' - 16'	V-TECH LINE SPORT	6036	400 x 350	-90	4	(*)
T-MAX 530	12' - 16'	V-TECH LINE TOURING	6260	590 x 425	+70	4	(*)
T-MAX 530	12' - 16'	V-TECH LINE SUPERSPORT	7499	330 x 470	-210	4	(*)
T-MAX/DX/SX	17' - 19'	V-TECH LINE SPORT	9423	335 x 430		4	(*)
T-MAX/DX/SX	17' - 19'	V-TECH LINE TOURING	9424	675 x 555	+115	4	(*)
T-MAX/DX/SX	17' - 19'	V-TECH LINE SUPERSPORT	9841	250 x 220	-200	4	(*)
T-MAX 560 /SX/DX/MAX TECH	20'	V-TECH LINE SPORT	9423	335 x 430		4	(*)
T-MAX 560 /SX/DX/MAX TECH	20'	V-TECH LINE TOURING	9424	675 x 555		4	(*)
T-MAX 560 /SX/DX/MAX TECH	20'	V-TECH LINE SUPERSPORT	9841	250 x 220		4	(*)
TRICITY	15' - 19'	V-TECH LINE TOURING	7666	710 x 520	+415	4	(*)
X-MAX 125	05' - 09'	V-TECH LINE TOURING	5015	370 x 410	+200	4	(*)
X-MAX 125	10' - 13'	V-TECH LINE SPORT	6837	300 x 350	-130	4	(*)
X-MAX 125	10' - 13'	V-TECH LINE TOURING	6259	560 x 430	+125	4	(*)
X-MAX 125	14' - 17'	V-TECH LINE SPORT	7503	366 x 370	-155	4	(*)
X-MAX 125	14' - 17'	V-TECH LINE TOURING	6874	660 x 540	+140	4	(*)
X-MAX 125	18' - 20'	V-TECH LINE SPORT	9474	430 x 350	-170	4	(*)
X-MAX 125	18' - 20'	V-TECH LINE TOURING	9476	715 x 570	+130	4	(*)
X-MAX 250	05' - 09'	V-TECH LINE TOURING	5015	370 x 410	+200	4	(*)
X-MAX 250	10' - 13'	V-TECH LINE SPORT	6837	300 x 350	-130	4	(*)
X-MAX 250	10' - 13'	V-TECH LINE TOURING	6259	560 x 430	+125	4	(*)
X-MAX 250	14' - 16'	V-TECH LINE SPORT	7503	366 x 370	-155	4	(*)
X-MAX 250	14' - 16'	V-TECH LINE TOURING	6874	660 x 540	+140	4	(*)
X-MAX 300	17' - 20'	V-TECH LINE SPORT	9474	430 x 350	-170	4	(*)
X-MAX 300	17' - 20'	V-TECH LINE TOURING	9476	715 x 570	+130	4	(*)

2021 MODELS: www.puig.tv

MODEL	YEAR	TYPE DE V-TECH LINE	REF.	DIMENSIONS (Height x Width)	HEIGHT (mm) Compared to OEM	THICKNESS (mm)	N W H F
X-MAX 400	13' - 17'	V-TECH LINE SPORT	7503	366 x 370	-155	4	(*)
X-MAX 400	13' - 17'	V-TECH LINE TOURING	6874	660 x 540	+140	4	(*)
X-MAX 400	18' - 20'	V-TECH LINE SPORT	9474	430 x 350	-170	4	(*)
X-MAX 400	18' - 20'	V-TECH LINE TOURING	9476	715 x 570	+130	4	(*)



N Black W Transparent H Smoke F Dark Smoke

(*) Check price with your distributor.

IMPORTANT: Indicate code color after part#. Example 0973A

MULTIADJUSTABLE VISORS FIXED BY SCREWS

HI-TECH PARTS | TECHNICAL SECTION

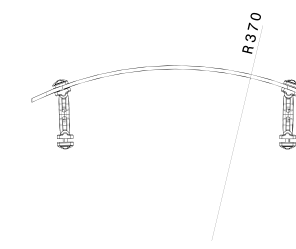
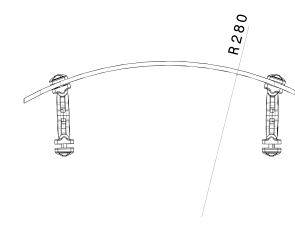
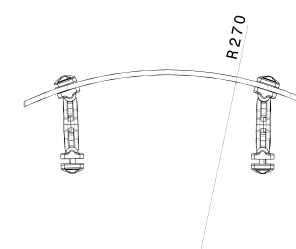
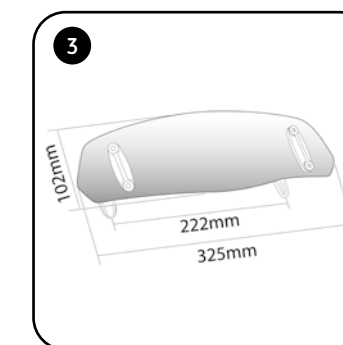
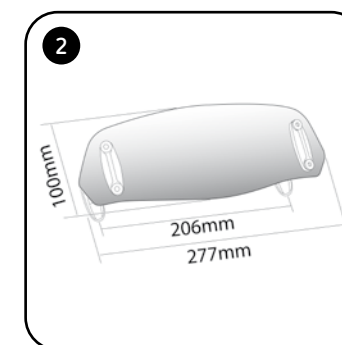
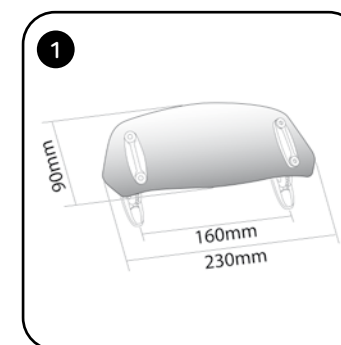

REFERENCE	W	H
6007	(*)	(*)

REFERENCE	W	H
5852	(*)	(*)

REFERENCE	W	H
5853	(*)	(*)

The multi-adjustable bolt-on visors can be mounted on the Puig windscreen as well as on the stock one.
Check compatibility and references in our website.

SPARES	REFERENCE	W	H	N
MULTI-ADJUSTABLE MECHANISM BY PAIR	6271			(*)
VISOR SPARE N.1 (230 x 90 mm.)	6268	(*)		
VISOR SPARE N.2 (277 x 100 mm.)	6269	(*)		
VISOR SPARE N.3 (325 x 102 mm.)	6270	(*)		

(*) Check price with your distributor.

IMPORTANT: Indicate code color after part#. Example 0973A

// ASSEMBLY PROCEDURE

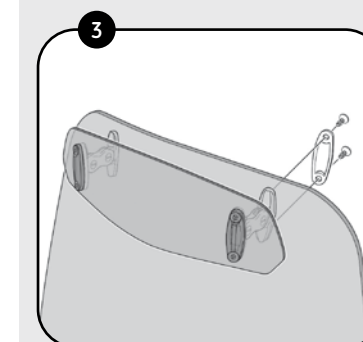
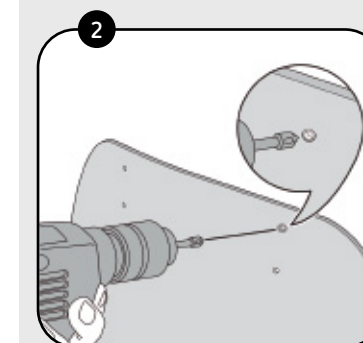
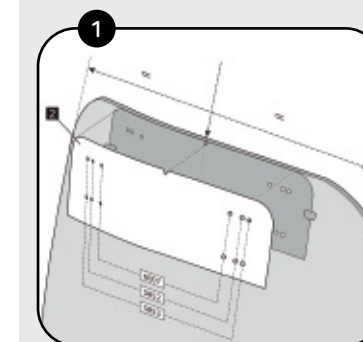

* Template supplied.

NOTE:
If order "touring with visor" kit, the windscreen will come factory-drilled so no drilling is necessary.

MULTIADJUSTABLE VISORS CLIP-ON

HI-TECH PARTS | TECHNICAL SECTION

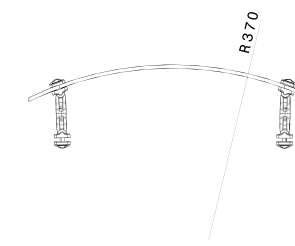
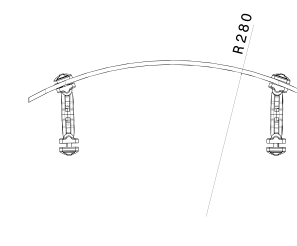
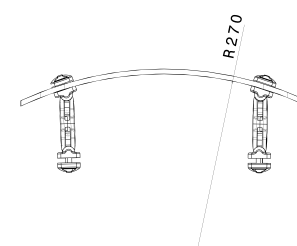
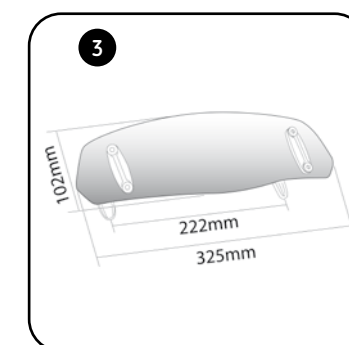
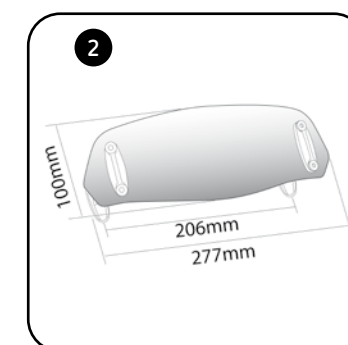
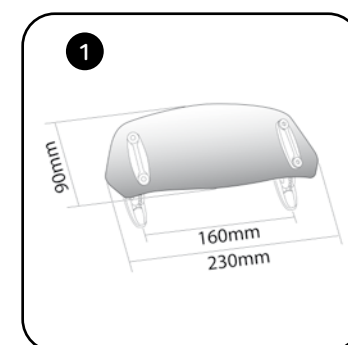
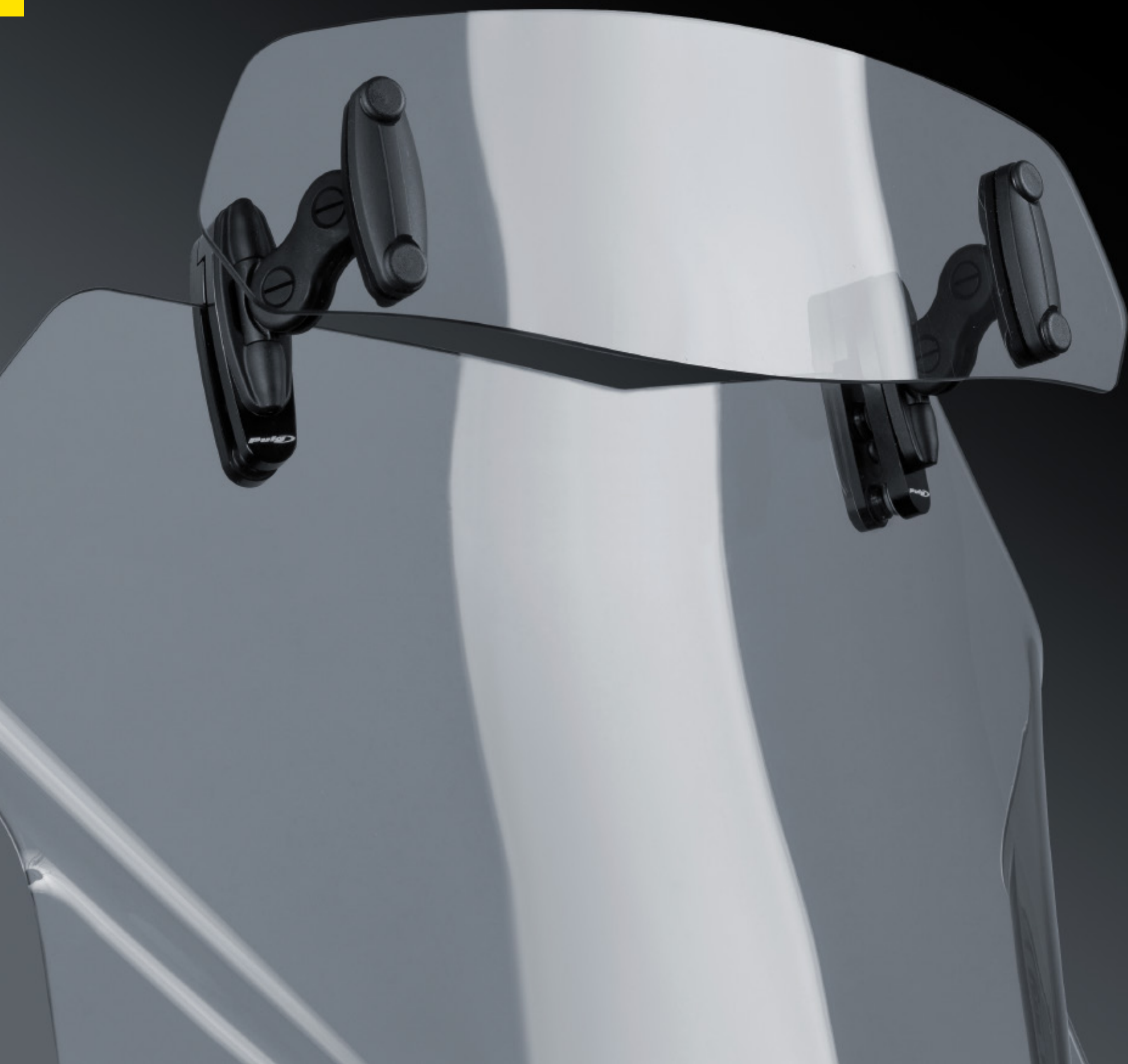

REFERENCE	W	H
6319		(*)

REFERENCE	W	H
6320		(*)

REFERENCE	W	H
6375		(*)

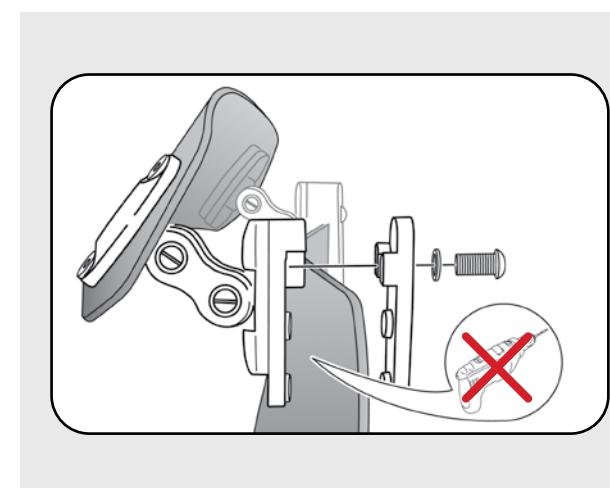

The multi-adjustable clip-on visors can be mounted on the Puig windshield as well as the stock one.

Check compatibility and references **in our website**.

Suitable screen thicknesses between 3 and 5 mm.

It's not necessary to drill the screen to hold the visor.

RECOMMENDATIONS: REF. 6319 for OEM windshields of 180 mm. minimum width; REF. 6320 for OEM windshields of 226 mm. minimum width; REF. 6375 for OEM windshields of 242 mm. minimum width.

SPARES	REFERENCE	W	H	N
MULTI-ADJUSTABLE MECHANISM BY PAIR	6799			(*)
VISOR SPARE N.1 (230X90 mm.)	6871		(*)	
VISOR SPARE N.2 (277X100 mm.)	6872		(*)	
VISOR SPARE N.3 (325X102 mm.)	6873		(*)	

DEFLECTORS FOR WINDSHIELDS

HI-TECH PARTS | TECHNICAL SECTION

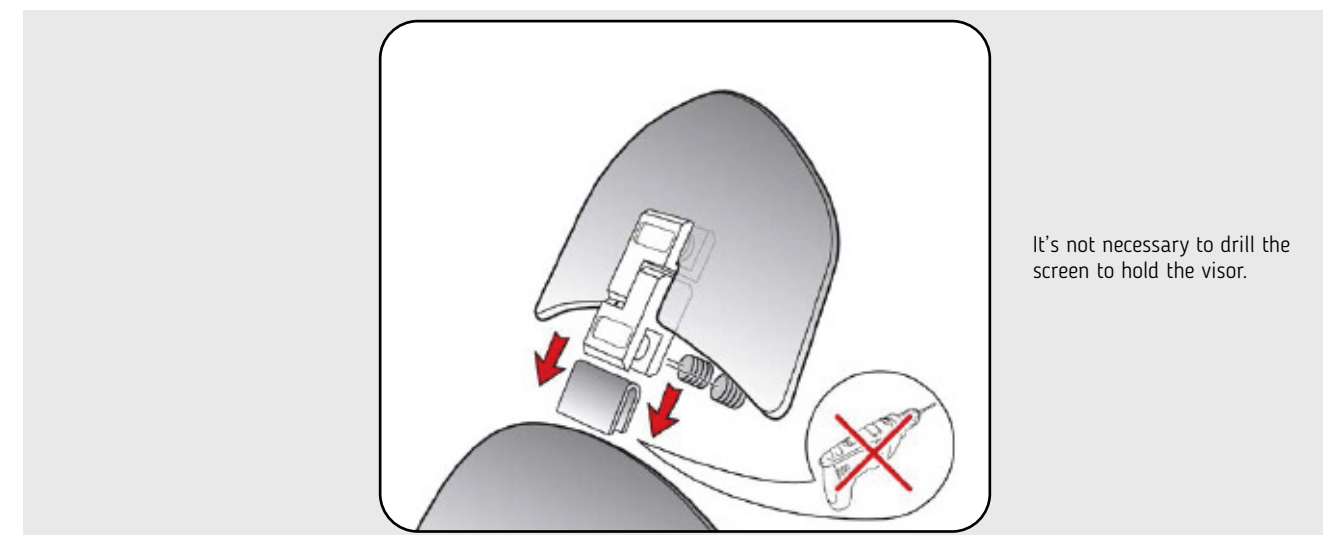

It's not necessary to drill the screen to hold the visor.

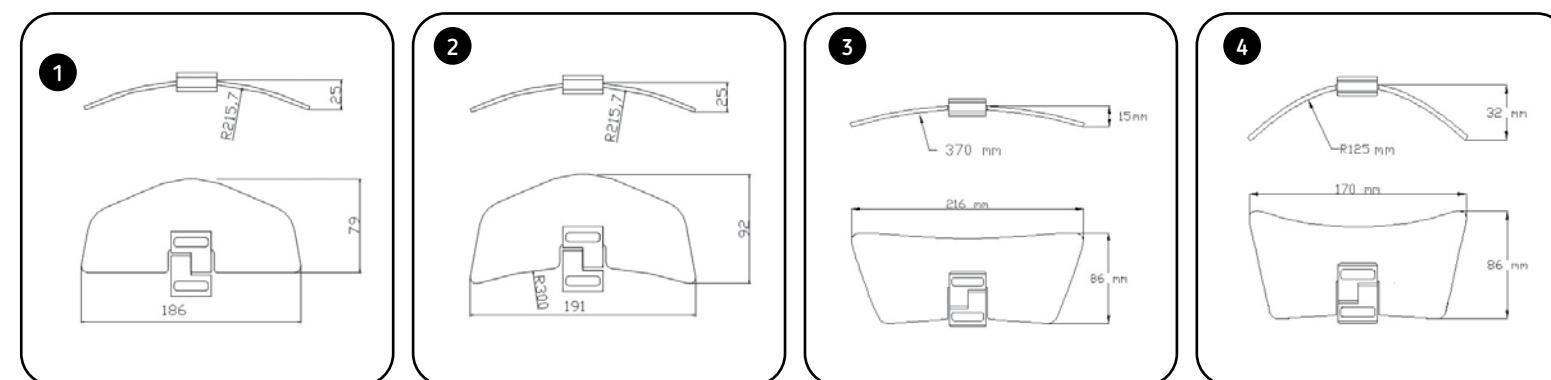

MODEL	REFERENCE	W	H	D
DEFLECTOR 1	4639	(*)	(*)	
DEFLECTOR 2	4717	(*)	(*)	
DEFLECTOR 3	4835	(*)		
DEFLECTOR 4	4837	(*)		
METALLIC MECHANISM	6878D			(*)



W
Transparent

H
Smoke

D
Anodized

(*) Check price with your distributor.
IMPORTANT: Indicate code color after part#. Example 0973A



SEMI-FAIRINGS

HI-TECH PARTS | TECHNICAL SECTION



// AERODYNAMIC TEST

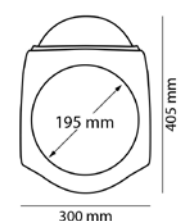

2 FIXATION POINTS

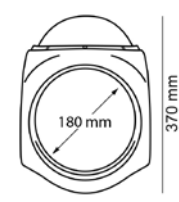

2 FIXATION POINTS



J
Matt black

C
Carbon look



BMW R NINE T
(REF. 9160F)

MODEL	REF.	F	H	W	N
UNIVERSAL BLACK SEMI-FAIRING Ø 195 mm.	9553				(*)
UNIVERSAL CARBON LOOK SEMI-FAIRING Ø 195 mm.	9515				(*)
UNIVERSAL BLACK SEMI-FAIRING Ø 180 mm.	9554				(*)
UNIVERSAL CARBON LOOK SEMI-FAIRING Ø 180 mm.	9516				(*)

SPARES	REF.	F	H	W	N	J	C
SEMI-FAIRING Ø 195 mm.	9230					(*)	(*)
SEMI-FAIRING Ø 180 mm.	9231					(*)	(*)
SCREEN Ø 195 mm.	9196				(*)		
SCREEN Ø 180 mm.	9872				(*)		
UNIVERSAL SUPPORTS SEMI-FAIRING Ø 195 mm.	9978N				(*)		
UNIVERSAL SUPPORTS SEMI-FAIRING Ø 180 mm.	9979N				(*)		

(*) Check price with your distributor.

IMPORTANT: Indicate code color after part#. Example: 0973A.

FOR SPECIFIC MODELS SEE PAGE 98.

RETROVISIONS

HI-TECH PARTS | TECHNICAL SECTION



// AERODYNAMIC TEST

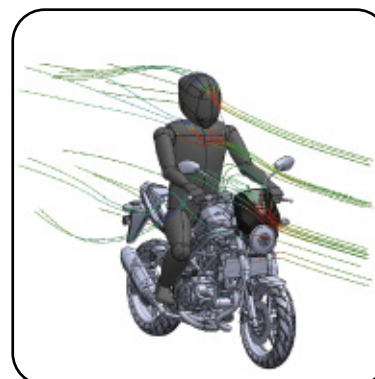

The retrovision is formed by a opaque base (black or carbon look) an a screen light, smoke,dark smoke, black or clear.



J Matt black

C Carbon look



DUCATI SCRAMBLER (REF. 7652)



310 mm

330 mm

2 FIXATION POINTS

MODEL	REF.
UNIVERSAL RETROVISION (#)	SEE PAGE 137
SPARES	REF. F H W N
SCREEN	1517 (*)

(*) Check price with your distributor.
 IMPORTANT: Indicate code color after part#. Example: 0973A.

FOR SPECIFIC MODELS SEE PAGE 98.
 (#) ADHESIVE KIT INCLUDED

FRONTAL PLATE (IN ALUMINIUM)

HI-TECH PARTS | TECHNICAL SECTION



// AERODYNAMIC TEST

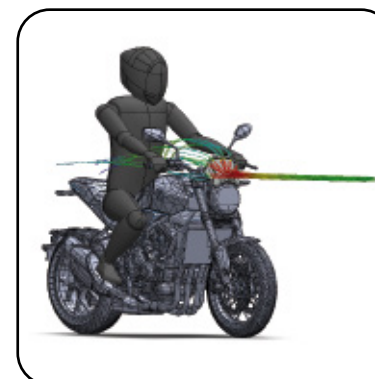

May be used as small screen for wind protection or as a number plate.

Look at adhesive numbers on page 103.

It carries a set of universal supports or specific supports for selected models.



REF. 9807P

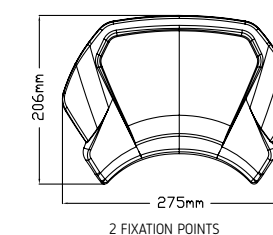

REF. 9807N



P
Aluminium



N
Black

MODEL	REF.	P	N
UNIVERSAL FRONT PLATE - FIXING TO FORKS	3592	(*)	(*)
UNIVERSAL FRONTAL PLATE - FIXING TO SUPPORTS OF THE FARE	3593	(*)	(*)

SPARES	REF.	P	N
ALUMINIUM FRONTAL PLATE	9807	(*)	(*)
UNIVERSAL SUPPORTS	9977	(*)	(*)

(*) Check price with your distributor.

IMPORTANT: Indicate code color after part#. Example: 0973A.

FOR SPECIFIC MODELS SEE PAGE 98.
ADHESIVE NUMBER SEE PAGE 103.

FRONTAL PLATE (IN ABS)

HI-TECH PARTS | TECHNICAL SECTION



// AERODYNAMIC TEST

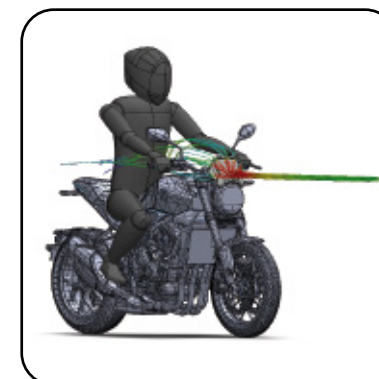

Double function: Deflects wind and number plate.
Available with universal supports or specific for selected motorcycles.

// FRONTAL PLATE

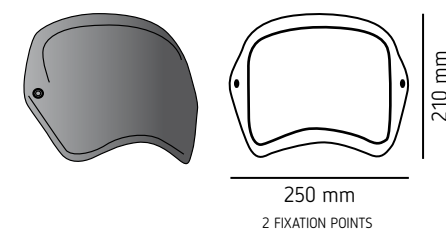

// ASYMETRIC FRONTAL PLATE (Only Ref. 9177, 9522)

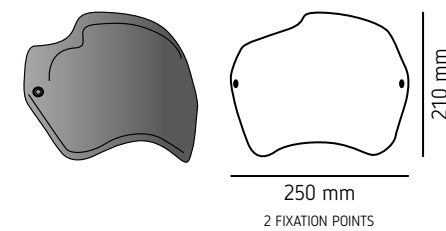

J
Matt black

C
Carbon look



REF. 9229C

MODEL	REF.	J	C
UNIVERSAL FRONT PLATE - FIXING TO FORKS	3590	(*)	(*)
UNIVERSAL FRONTAL PLATE - FIXING TO THE LIGHT SUPPORT	3591	(*)	(*)

SPARES	REF.	J	C	N
FRONTAL PLATE	9229	(*)	(*)	
UNIVERSAL SUPPORTS	9977			(*)

(*) Check price with your distributor.

IMPORTANT: Indicate code color after part#. Example: 0973A.

FOR SPECIFIC MODELS SEE PAGE 98.
ADHESIVE NUMBER SEE PAGE 103.

RETROVISIONS | FRONTAL PLATES | SEMI-FAIRING

HI-TECH PARTS



SEMI-FAIRING

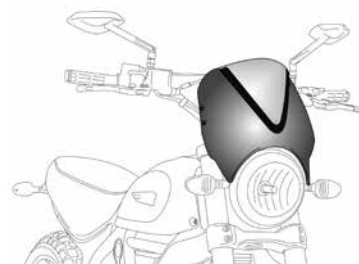

RETROVISIONS

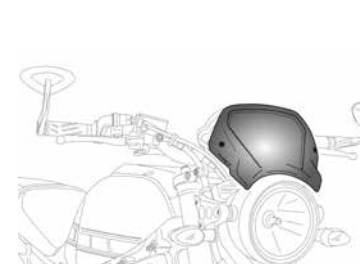

ALUMINIUM FRONTAL PLATE

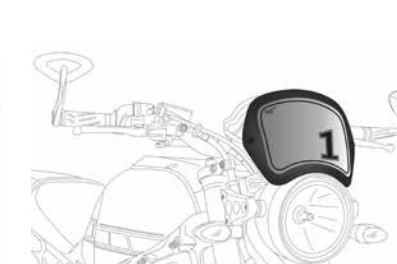

ABS FRONTAL PLATE

2021 MODELS: www.puig.tv

MODEL	YEAR	TYPE	COLOR	REF.	F	H	J	C	P
BMW									
R NINE T	14' - 20'	RETROVISION	MATT BLACK	7012	(*)				
R NINE T	14' - 20'	RETROVISION	CARBON LOOK	7559	(*)				
R NINE T	14' - 20'	ABS FRONTAL PLATE		9167			(*)	(*)	
R NINE T	14' - 20'	ALUMINIUM FRONTAL PLATE		9798	(*)				(*)
R NINE T	14' - 20'	SEMI-FAIRING	MATT BLACK	9160	(*)				
R NINE T	14' - 20'	SEMI-FAIRING	CARBON LOOK	9178	(*)				
R NINE T SCRAMBLER	16' - 20'	RETROVISION	MATT BLACK	9338	(*)				
R NINE T SCRAMBLER	16' - 20'	RETROVISION	CARBON LOOK	9339	(*)				
R NINE T SCRAMBLER	16' - 20'	ABS FRONTAL PLATE		9252			(*)	(*)	
R NINE T SCRAMBLER	16' - 20'	ALUMINIUM FRONTAL PLATE		9797	(*)				(*)
R NINE T SCRAMBLER	16' - 20'	SEMI-FAIRING	MATT BLACK	9253	(*)				
R NINE T SCRAMBLER	16' - 20'	SEMI-FAIRING	CARBON LOOK	9254	(*)				
R NINE T PURE	17' - 20'	RETROVISION	MATT BLACK	7012	(*)				
R NINE T PURE	17' - 20'	RETROVISION	CARBON LOOK	7559	(*)				
R NINE T PURE	17' - 20'	ABS FRONTAL PLATE		9167			(*)	(*)	
R NINE T PURE	17' - 20'	ALUMINIUM FRONTAL PLATE		9798	(*)				(*)
DUCATI									
SCRAMBLER 800 ICON DARK	20'	ABS FRONTAL PLATE ASYMETRIC		9177			(*)	(*)	
SCRAMBLER 800 ICON DARK	20'	ALUMINIUM FRONTAL PLATE		9799	(*)				(*)
SCRAMBLER 800 ICON DARK	20'	RETROVISION	MATT BLACK	7652	(*)				
SCRAMBLER 800 ICON DARK	20'	RETROVISION	CARBON LOOK	8192	(*)				
SCRAMBLER 1100	18' - 20'	ASYMETRIC ABS FRONTAL PLATE		9522			(*)	(*)	
SCRAMBLER 1100	18' - 20'	ALUMINIUM FRONTAL PLATE		9800	(*)				(*)
SCRAMBLER 1100 SPORT	18' - 20'	ASYMETRIC ABS FRONTAL PLATE		9522			(*)	(*)	
SCRAMBLER 1100 SPORT	18' - 20'	ALUMINIUM FRONTAL PLATE		9800	(*)				(*)
SCRAMBLER 1100 SPECIAL	18' - 20'	ASYMETRIC ABS FRONTAL PLATE		9522			(*)	(*)	
SCRAMBLER 1100 SPECIAL	18' - 20'	ALUMINIUM FRONTAL PLATE		9800	(*)				(*)
SCRAMBLER CAFE RACER	17' - 20'	ASYMETRIC ABS FRONTAL PLATE		9177			(*)	(*)	
SCRAMBLER CAFE RACER	17' - 20'	ALUMINIUM FRONTAL PLATE		9799	(*)				(*)
SCRAMBLER DESERT SLED	17' - 20'	RETROVISION	MATT BLACK	7652	(*)				
SCRAMBLER DESERT SLED	17' - 20'	RETROVISION	CARBON LOOK	8192	(*)				
SCRAMBLER DESERT SLED	17' - 20'	ASYMETRIC ABS FRONTAL PLATE		9522			(*)	(*)	

2021 MODELS: www.puig.tv

MODEL	YEAR	TYPE	COLOR	REF.	F	H	J	C	P
SCRAMBLER DESERT SLED	17' - 20'	ALUMINIUM FRONTAL PLATE		9800	(*)				(*)
SCRAMBLER FLAT TRACK PRO	16'	RETROVISION	MATT BLACK	7652	(*)				
SCRAMBLER FLAT TRACK PRO	16'	RETROVISION	CARBON LOOK	8192	(*)				
SCRAMBLER FLAT TRACK PRO	16'	ABS FRONTAL PLATE ASYMETRIC		9177			(*)	(*)	
SCRAMBLER FLAT TRACK PRO	16'	ALUMINIUM FRONTAL PLATE		9799	(*)				(*)
SCRAMBLER ICON/CLASSIC/FULL THROTTLE	15' - 20'	RETROVISION	MATT BLACK	7652	(*)				
SCRAMBLER ICON/CLASSIC/FULL THROTTLE	15' - 20'	RETROVISION	CARBON LOOK	8192	(*)				
SCRAMBLER ICON/CLASSIC/FULL THROTTLE	15' - 20'	ABS FRONTAL PLATE ASYMETRIC		9177			(*)	(*)	
SCRAMBLER ICON/CLASSIC/FULL THROTTLE	15' - 20'	ALUMINIUM FRONTAL PLATE		9799	(*)				(*)
SCRAMBLER SIXTY2	16' - 20'	RETROVISION	MATT BLACK	7652	(*)				
SCRAMBLER SIXTY2	16' - 20'	RETROVISION	CARBON LOOK	8192	(*)				
SCRAMBLER URBAN ENDURO	15' - 16'	RETROVISION	MATT BLACK	7652	(*)				
SCRAMBLER URBAN ENDURO	15' - 16'	RETROVISION	CARBON LOOK	8192	(*)				
SCRAMBLER URBAN ENDURO	15' - 16'	ABS FRONTAL PLATE ASYMETRIC		9177			(*)	(*)	
SCRAMBLER URBAN ENDURO	15' - 16'	ALUMINIUM FRONTAL PLATE		9799	(*)				(*)
HARLEY DAVIDSON									
SPORTSTER 883 IRON	09' - 20'	ABS FRONTAL PLATE		1351			(*)	(*)	
SPORTSTER 883 IRON	09' - 20'	ALUMINIUM FRONTAL PLATE		1352	(*)				(*)
SPORTSTER FORTY-EIGHT 48	17' - 20'	ABS FRONTAL PLATE		20399			(*)	(*)	
SPORTSTER FORTY-EIGHT 48	17' - 20'	ALUMINIUM FRONTAL PLATE		20400	(*)				(*)
HONDA									
CB125R NEO SPORTS CAFE	18' - 20'	ABS FRONTAL PLATE		9663			(*)	(*)	
CB125R NEO SPORTS CAFE	18' - 20'	ALUMINIUM FRONTAL PLATE		9802	(*)				(*)
CB300R NEO SPORTS CAFE	18' - 20'	ABS FRONTAL PLATE		9663			(*)	(*)	
CB300R NEO SPORTS CAFE	18' - 20'	ALUMINIUM FRONTAL PLATE		9802	(*)				(*)
CB650R NEO SPORTS CAFÉ	19'-20'	ABS FRONTAL PLATE		9768			(*)	(*)	
CB650R NEO SPORTS CAFÉ	19'-20'	ALUMINIUM FRONTAL PLATE		9803	(*)				(*)
CB650R NEO SPORTS CAFÉ	19'-20'	SEMI-FAIRING	MATT BLACK	3133	(*)				
CB650R NEO SPORTS CAFÉ	19'-20'	SEMI-FAIRING	CARBON LOOK	3143	(*)				
CB1000R NEO SPORTS CAFE	18' - 20'	ABS FRONTAL PLATE		9768			(*)	(*)	
CB1000R NEO SPORTS CAFE	18' - 20'	ALUMINIUM FRONTAL PLATE		9803	(*)				(*)
CB1000R NEO SPORTS CAFE	18' - 20'	SEMI-FAIRING	MATT BLACK	3133	(*)				
CB1000R NEO SPORTS CAFE	18' - 20'	SEMI-FAIRING	CARBON LOOK	3143	(*)				
CB1100	13' - 14'	RETROVISION	CARBON LOOK	7594	(*)				
CB1100	13' - 14'	SEMI-FAIRING	MATT BLACK	9553	(*)				
CB1100	13' - 14'	SEMI-FAIRING	CARBON LOOK	9515	(*)				
CB1100 EX	14' - 20'	SEMI-FAIRING	MATT BLACK	9553	(*)				
CB1100 EX	14' - 20'	SEMI-FAIRING	CARBON LOOK	9515	(*)				
CB1100 EX	14' - 20'	ABS FRONTAL PLATE		3591			(*)	(*)	
CB1100 EX	14' - 20'	ALUMINIUM FRONTAL PLATE		3593	(*)				(*)

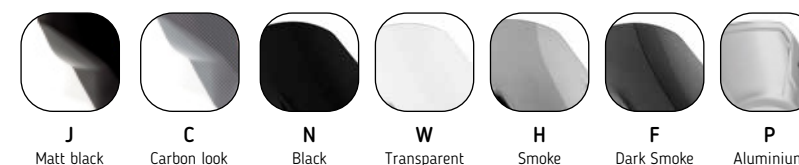

(*) Check price with your distributor.

IMPORTANT: Indicate code color after part#. Example 0973A

RETROVISIONS | FRONTAL PLATES | SEMI-FAIRING

HI-TECH PARTS

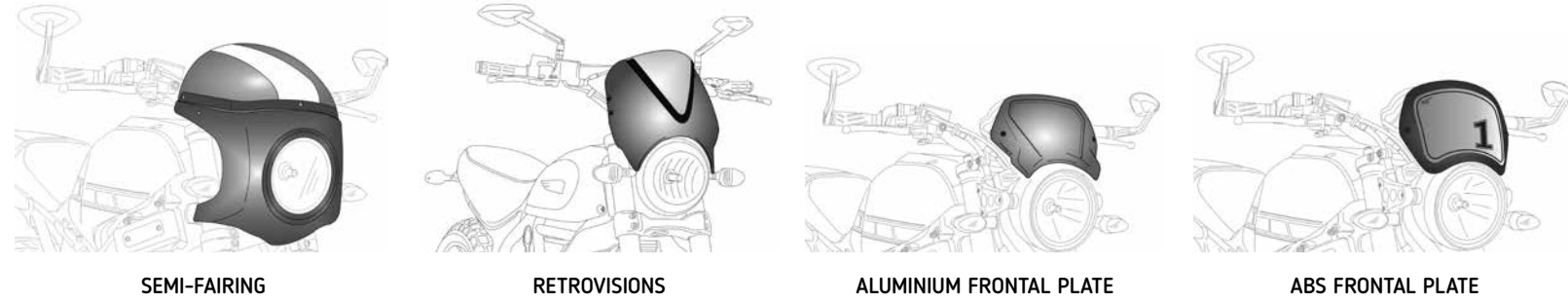

2021 MODELS: www.puig.tv

MODEL	YEAR	TYPE	COLOR	REF.	F	H	J	C	P
ROYAL ENFIELD									
INTERCEPTOR 650		ABS FRONTAL PLATE		3591			(*)	(*)	
INTERCEPTOR 650		ALUMINIUM FRONTAL PLATE		3593	(*)				(*)
INTERCEPTOR 650		SEMI-FAIRING	MATT BLACK	9554	(*)				
INTERCEPTOR 650		SEMI-FAIRING	CARBON LOOK	9516	(*)				
SUZUKI									
SV650	16' - 20'	RETROVISION	MATT BLACK	8926	(*)				
SV650	16' - 20'	RETROVISION	CARBON LOOK	8927	(*)				
SV650	16' - 20'	SEMI-FAIRING	MATT BLACK	3169	(*)				
SV650	16' - 20'	SEMI-FAIRING	CARBON LOOK	3170	(*)				
SV650	16' - 20'	ABS FRONTAL PLATE		3590			(*)	(*)	
SV650	16' - 20'	ALUMINIUM FRONTAL PLATE		3592	(*)				(*)
TRIUMPH									
BONNEVILLE SPEEDMASTER	18' - 20'	ABS FRONTAL PLATE		3590			(*)	(*)	
BONNEVILLE SPEEDMASTER	18' - 20'	ALUMINIUM FRONTAL PLATE		3592	(*)				(*)
BONNEVILLE SPEEDMASTER	18' - 20'	SEMI-FAIRING	MATT BLACK	9554	(*)				
BONNEVILLE SPEEDMASTER	18' - 20'	SEMI-FAIRING	CARBON LOOK	9516	(*)				
BONNEVILLE T100	16' - 18'	ABS FRONTAL PLATE		9191			(*)	(*)	
BONNEVILLE T100	16' - 18'	ALUMINIUM FRONTAL PLATE		9808	(*)				(*)
BONNEVILLE T100	16' - 18'	SEMI-FAIRING	MATT BLACK	9176	(*)				
BONNEVILLE T100	16' - 18'	SEMI-FAIRING	CARBON LOOK	9195	(*)				
BONNEVILLE T120	16' - 19'	ABS FRONTAL PLATE		9191			(*)	(*)	
BONNEVILLE T120	16' - 19'	ALUMINIUM FRONTAL PLATE		9808	(*)				(*)
BONNEVILLE T120	16' - 19'	SEMI-FAIRING	MATT BLACK	9176	(*)				
BONNEVILLE T120	16' - 19'	SEMI-FAIRING	CARBON LOOK	9195	(*)				
SCRAMBLER 1200XC	19' - 20'	ABS FRONTAL PLATE		3590			(*)	(*)	
SCRAMBLER 1200XC	19' - 20'	ALUMINIUM FRONTAL PLATE		3592	(*)				(*)
SPEED TWIN	19' - 20'	ABS FRONTAL PLATE		3591			(*)	(*)	
SPEED TWIN	19' - 20'	ALUMINIUM FRONTAL PLATE		3593	(*)				(*)
SPEED TWIN	19' - 20'	SEMI-FAIRING	MATT BLACK	9553	(*)				
SPEED TWIN	19' - 20'	SEMI-FAIRING	CARBON LOOK	9515	(*)				
STREET TWIN	16' - 20'	SEMI-FAIRING	MATT BLACK	9553	(*)				
STREET TWIN	16' - 20'	SEMI-FAIRING	CARBON LOOK	9515	(*)				
THRUXTON 1200/R	16' - 20'	SEMI-FAIRING	MATT BLACK	9553	(*)				
THRUXTON 1200/R	16' - 20'	SEMI-FAIRING	CARBON LOOK	9515	(*)				
YAMAHA									
SCR950	17' - 20'	ABS FRONTAL PLATE		3590			(*)	(*)	
SCR950	17' - 20'	ALUMINIUM FRONTAL PLATE		3592	(*)				(*)
XSR700	16' - 20'	RETROVISION	MATT BLACK	9560	(*)				
XSR700	16' - 20'	RETROVISION	CARBON LOOK	9561	(*)				

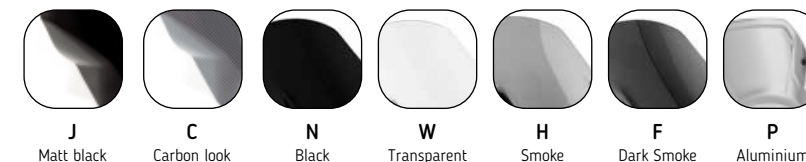

(*) Check price with your distributor.
IMPORTANT: Indicate code color after part#. Example 0973A

RETROVISIONS | FRONTAL PLATES | SEMI-FAIRING

HI-TECH PARTS

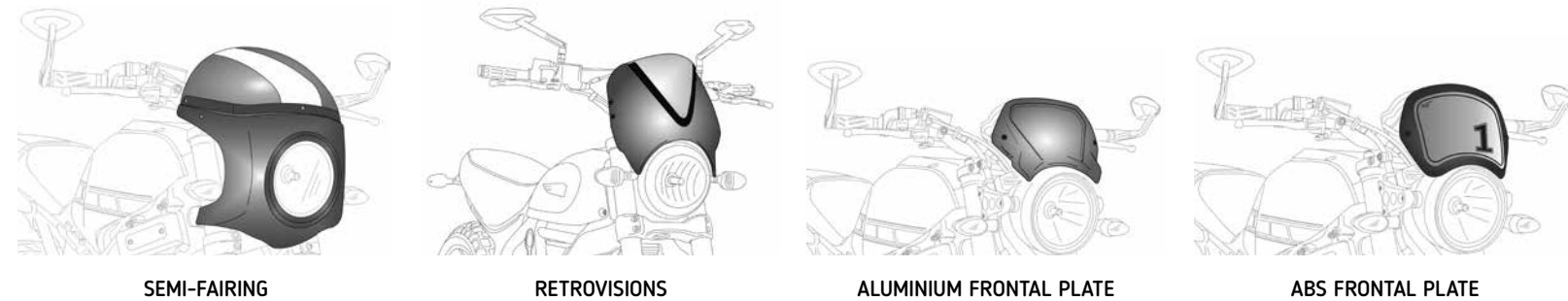

2021 MODELS: www.puig.tv

MODEL	YEAR	TYPE	COLOR	REF.	F W	H N	J	C	P
XSR700	16' - 20'	SEMI-FAIRING	MATT BLACK	8933	(*)				
XSR700	16' - 20'	SEMI-FAIRING	CARBON LOOK	9187	(*)				
XSR700	16' - 20'	ABS FRONTAL PLATE		3591			(*)	(*)	
XSR700	16' - 20'	ALUMINIUM FRONTAL PLATE		3593	(*)				(*)
XSR700 XTRIBUTE	19' - 20'	RETROVISION	MATT BLACK	9560	(*)				
XSR700 XTRIBUTE	19' - 20'	RETROVISION	CARBON LOOK	9561	(*)				
XSR700 XTRIBUTE	19' - 20'	SEMI-FAIRING	MATT BLACK	8933	(*)				
XSR700 XTRIBUTE	19' - 20'	SEMI-FAIRING	CARBON LOOK	9187	(*)				
XSR700 XTRIBUTE	19' - 20'	ABS FRONTAL PLATE		3591			(*)	(*)	
XSR700 XTRIBUTE	19' - 20'	ALUMINIUM FRONTAL PLATE		3593	(*)				(*)
XSR900	16' - 20'	RETROVISION	MATT BLACK	9560	(*)				
XSR900	16' - 20'	RETROVISION	CARBON LOOK	9561	(*)				
XSR900	16' - 20'	SEMI-FAIRING	MATT BLACK	8934	(*)				
XSR900	16' - 20'	SEMI-FAIRING	CARBON LOOK	9188	(*)				
XSR900	16' - 20'	ABS FRONTAL PLATE		9168			(*)	(*)	
XSR900	16' - 20'	ALUMINIUM FRONTAL PLATE		9806	(*)				(*)
XV950	14' - 20'	ABS FRONTAL PLATE		3812			(*)	(*)	
XV950	14' - 20'	ALUMINIUM FRONTAL PLATE		3813	(*)				(*)
XV950R	14' - 20'	ABS FRONTAL PLATE		3812			(*)	(*)	
XV950R	14' - 20'	ALUMINIUM FRONTAL PLATE		3813	(*)				(*)
XV950 RACER	14' - 20'	ABS FRONTAL PLATE		3812			(*)	(*)	
XV950 RACER	14' - 20'	ALUMINIUM FRONTAL PLATE		3813	(*)				(*)

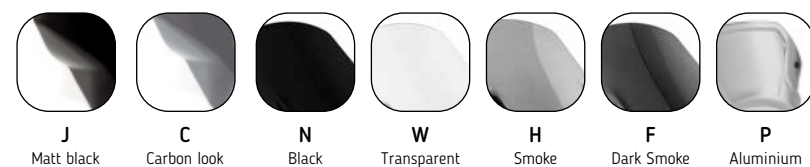

(*) Check price with your distributor.
IMPORTANT: Indicate code color after part#. Example: 0973A.

NUMBERS

HI-TECH PARTS | TECHNICAL SECTION



MODEL	PACK	REF.	R B	V G	A P	N
0	5 UNITS	4263	(*)			
1	5 UNITS	4254	(*)			
2	5 UNITS	4255	(*)			
3	5 UNITS	4256	(*)			
4	5 UNITS	4257	(*)			
5	5 UNITS	4258	(*)			
6	5 UNITS	4259	(*)			
7	5 UNITS	4260	(*)			
8	5 UNITS	4261	(*)			
9	5 UNITS	4262	(*)			
DISPLAY		2562N	(*)			

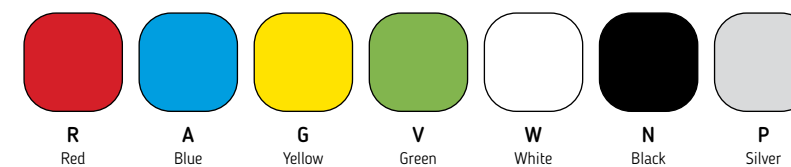

(*) Check price with your distributor.
IMPORTANT: Indicate code color after part#. Example: 0973A.

WINDSHIELD SPECIFIC FOR NON-ROUND HEADLIGHTS

HI-TECH PARTS | TECHNICAL SECTION



// VIRTUAL WIND TUNNEL TESTED

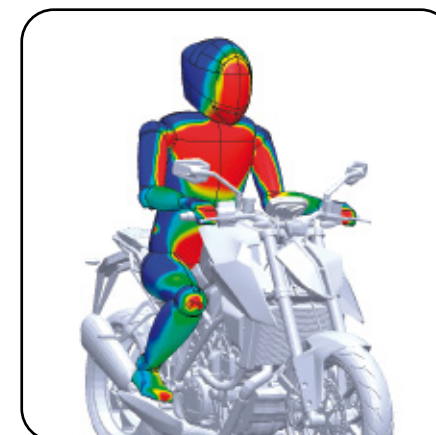

● Lower pressure
● Max. pressure
Wind pressure without Windshield Naked New Generation Puig.

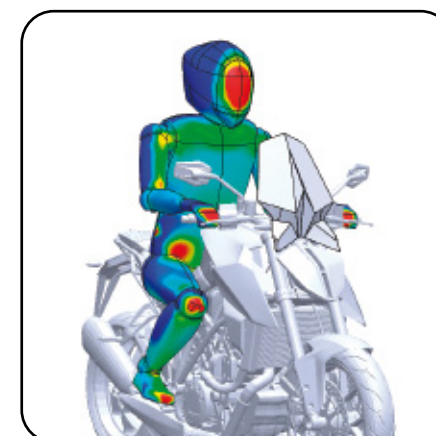

● Lower pressure
● Max. pressure
Wind pressure with Windshield Naked New Generation Puig.

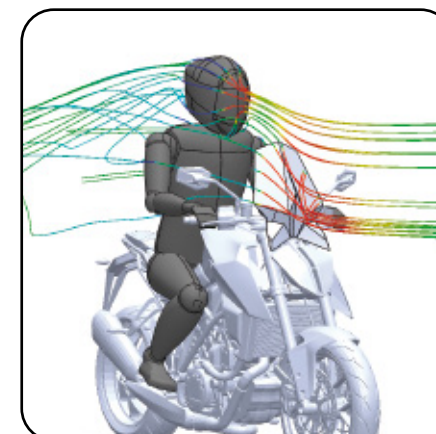

Improve aerodynamics and windprotection.

At PUIG, depending on the model, we apply a silkscreen or not on our windscreens to hide unattractive parts of the motorcycle.

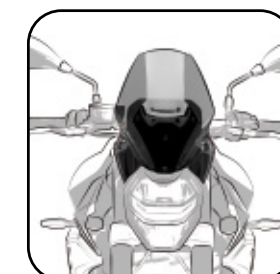

F900R
Serigraphed windscreen brilliant in the interior



GSX-S750
Windscreen without silkscreened



Z900
Silkscreened windscreen in black matt on the outside



The shape of the windshield may vary according to the motorcycle model. Please visit our website.



WINDSHIELD SPECIFIC FOR NON-ROUND HEADLIGHTS

HI-TECH PARTS | TYPE OF WINDSCREEN:

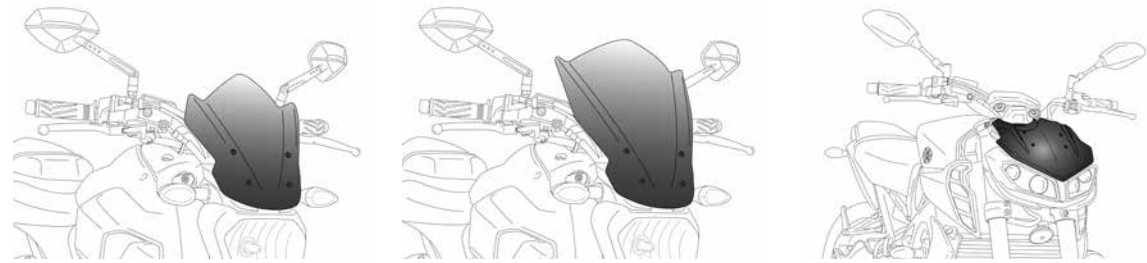

SPORT

TOURING

SPORT PLUS

2021 MODELS: www.puig.tv

MODEL	YEAR	TYPE	REF.	DIMENSIONS (Height x Width)	HEGHT (mm) Compared to OEM	THICKNESS (mm)	R N	T W	G H	V F	A C
APRILIA											
DORSODURO 750	08' - 16'	TOURING	4947	330 x 395		3	(*)	(*)			
DORSODURO 900	17' - 20'	TOURING	4947	330 x 395		3	(*)	(*)			
DORSODURO 1200	11' - 16'	TOURING	4947	330 x 395		3	(*)	(*)			
SHIVER 750	07' - 09'	SPORT	4674	330 x 345		3	(*)				
SHIVER 750	07' - 09'	SPORT	3767	305 x 273	+120	3	(*)				
SHIVER 900	17' - 20'	SPORT	4674	330 x 345		3	(*)				
SHIVER 900	17' - 20'	SPORT	3767	305 x 273	+120	3	(*)				
BENELLI											
502C	19' - 20'	SPORT	3690	260 x 240	125	3	(*)				
LEONCINO 500	16' - 20'	SPORT	9747	295 x 258	+110	4	(*)				
LEONCINO TRAIL	17' - 20'	SPORT	9747	295 x 258	+110	4	(*)				
BMW											
F800 R	09' - 14'	SPORT	5051 (-)	330 x 310		3	(*)	(*)			
F800 R	15' - 20'	SPORT	7650	310 x 240	+140	3	(*)	(*)			
F800 R	15' - 20'	TOURING	8187	430 x 350	+265	3	(*)				
F900 R	20'	SPORT (1)	20359				(*)				
F900 R	20'	SPORT (2)	20360				(*)				
F900 R	20'	TOURING (2)	20361				(*)				
F900 R	20'	TOURING (1)	20362				(*)				
G310 R	16' - 20'	SPORT	8920	305 x 275	+160	3	(*)	(*)			
K1300 R	09' - 16'	SPORT	4940	390 x 425	+60	3	(*)				
R1200 R	06' - 14'	SPORT	6488	350 x 320	+130	4	(*)				

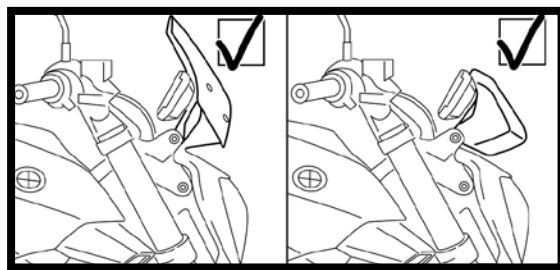

BMW R1200R 15' - 18' / R1250R 19'

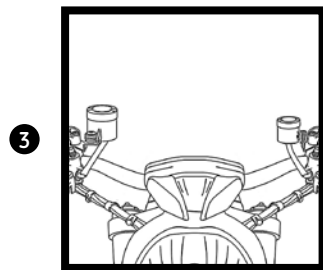
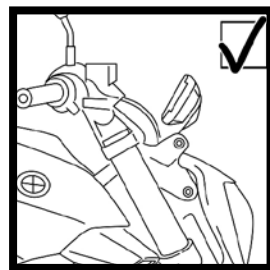

REF. 7013

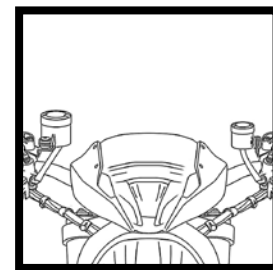

REF. 8900

2021 MODELS: www.puig.tv

MODEL	YEAR	TYPE	REF.	DIMENSIONS (Height x Width)	HEGHT (mm) Compared to OEM	THICKNESS (mm)	R N	T W	G H	V F	A C
R1200 R	15' - 18'	SPORT (1)	7651	365 x 300	+95	4	(*)				
R1200 R	15' - 18'	SPORT (2)	8168	370 x 295	+95		(*)				
R1200 R	15' - 18'	TOURING (2)	8110	530 x 360	+250		(*)				
R1200 R	15' - 18'	TOURING (1)	8165	525 x 360	+250	4	(*)				
R1250 R	19' - 20'	SPORT (1)	3623	335 x 300	+195	4	(*)				
R1250 R	19' - 20'	SPORT (2)	3624	335 x 300	+195	4	(*)				
R1250 R	19' - 20'	TOURING (2)	3625	350 x 455	+290	4	(*)				
R1250 R	19' - 20'	TOURING (1)	3626	350 x 455	+290	4	(*)				
S1000 R	14' - 18'	SPORT	7040	335 x 270	+170	3	(*)	(*)			
DUCATI											
DIAVEL	11' - 13'	TOURING	5655 (-)	450 x 355	+65	3	(*)				
DIAVEL	14' - 18'	SPORT ADJUSTABLE	7592 (-)	290 x 235	+65	3	(*)				
DIAVEL	14' - 18'	TOURING ADJUSTABLE	7570 (-)	445 x 350	+65	3	(*)				
DIAVEL 1260/S	19' - 20'	SPORT ADJUSTABLE	3773 (-)				(*)				
DIAVEL 1260/S	19' - 20'	TOURING ADJUSTABLE	3775 (-)				(*)				
HYPERMOTARD 821/SP	13' - 15'	SPORT	6489	295 x 280	+150	3	(*)	(*)			
HYPERMOTARD 939/SP	16' - 18'	SPORT	6489	295 x 280		3	(*)	(*)			
HYPERMOTARD 950/SP	19'	SPORT	3634	360 x 288	+230	3	(*)				
MONSTER 696	08' - 14'	SPORT	4672	245 x 240		3	(*)				
MONSTER 796	10' - 14'	SPORT	4672	245 x 240		3	(*)				
MONSTER 797	17' - 20'	SPORT (3)	7013	270 x 280		3	(*)	(*)			
MONSTER 797	17' - 20'	TOURING (4)	8900	290 X 180	+100	3	(*)				
MONSTER 821	14' - 20'	SPORT (3)	7013	270 x 280	+100	3	(*)	(*)			
MONSTER 821	14' - 20'	TOURING (4)	8900	290 X 180	+100	3	(*)				
MONSTER 1100/S	09' - 10'	SPORT	4672	245 x 240		3	(*)				
MONSTER 1100 EVO	11' - 13'	SPORT	4672	245 x 240		3	(*)				
MONSTER 1200/S	14' - 16'	SPORT (3)	7013	270 x 280	+100	3	(*)	(*)			
MONSTER 1200/S	14' - 16'	TOURING (4)	8900	290 X 180	+100	3	(*)				
MONSTER 1200/S	17' - 20'	SPORT (3)	7013	270 x 280	+100	3	(*)	(*)			
MONSTER 1200/S	17' - 20'	TOURING (4)	8900	290 X 180	+100	3	(*)				
MONSTER 1200 R	16' - 20'	SPORT (3)	7013	270 x 280	+100	3	(*)	(*)			
MONSTER 1200 R	16' - 20'	TOURING (4)	8900	290 X 180	+100	3	(*)				
STREETFIGHTER V4/S	20'	SPORT	20467				(*)				
X DIAVEL/S	16' - 18'	SPORT ADJUSTABLE	8921 (-)	295 x 250		3	(*)	(*)			
X DIAVEL/S	16' - 18'	TOURING ADJUSTABLE	8922 (-)	450 x 355		3	(*)				
HARLEY DAVIDSON											
SPORTSTER 883 IRON	09' - 20'	TOURING	9283	275 x 220		4	(*)				
SPORTSTER 883 LOW	04' - 10'	TOURING	9283	275 x 220		4	(*)				
SPORTSTER 883 SUPERLOW	11' - 20'	TOURING	9283	275 x 220		4	(*)				
SPORTSTER 1200 CUSTOM	04' - 10'	TOURING	9283	275 x 220		4	(*)				
SPORTSTER 1200 CB CUSTOM	13' - 17'	TOURING	9283	275 x 220		4	(*)				

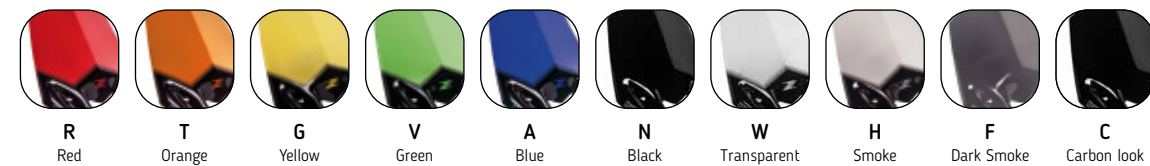

NOTE COLORS: F AND N COLORS DELIVERED WITHOUT SILK PRINT.

(-) Adjustable in width and height.
 (*) Check price with your distributor.
 (#) Only compatible with Triumph Bonneville Bobber with 41 mm. fork.
 (#) This windshield is not compatible with this model Bonneville Bobber Black with 47mm fork.

IMPORTANT: Indicate code color after part#. Example 0973A

WINDSHIELD SPECIFIC FOR NON-ROUND HEADLIGHTS

HI-TECH PARTS | TYPE OF WINDSCREEN:

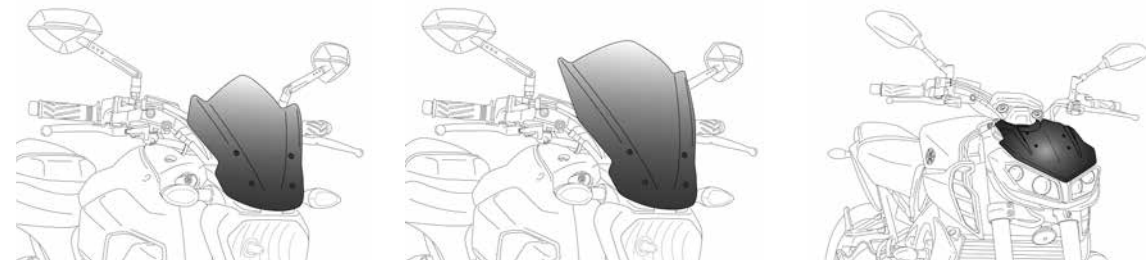

SPORT

TOURING

SPORT PLUS

2021 MODELS: www.puig.tv

MODEL	YEAR	TYPE	REF.	DIMENSIONS (Height x Width)	HEIGHT (mm) Compared to OEM	THICKNESS (mm)	R T G V A N W H F C
HONDA							
SPORTSTER 1200 IRON	18' - 20'	TOURING	9283	275 x 220		4	(*)
SPORTSTER 1200 NIGHTSTER	08' - 12'	TOURING	9283	275 x 220		4	(*)
SPORTSTER 1200 LOW	07' - 09'	TOURING	9283	275 x 220		4	(*)
SPORTSTER FORTY-EIGHT	10' - 20'	TOURING	9283	275 x 220		4	(*)
SPORTSTER SEVENTY-TWO	13' - 16'	TOURING	9283	275 x 220		4	(*)
CB125F	15' - 20'	SPORT	7726	400 x 340	+270	3	(*) (*)
CB125R NEO SPORTS CAFE	18' - 20'	SPORT	9734	348 x 290	+190	3	(*)
CB300F	15' - 20'	SPORT	7655	295 x 370		3	(*) (*)
CB300R NEO SPORTS CAFE	18' - 20'	SPORT	9734	348 x 290	+190	3	(*)
CB500F	13' - 15'	SPORT	6437	365 x 280	+150	3	(*)
CB500F	16' - 18'	SPORT	3657	370 x 295		3	(*)
CB500F	19' - 20'	SPORT	3657	370 x 295		3	(*)
CB650F	14' - 16'	SPORT	9687	360 x 280	+220	3	(*)
CB650F	17' - 20'	SPORT	9687	300 x 280		3	(*)
CB650R NEO SPORTS CAFÉ	19' - 20'	SPORT	9748	348 x 290	+190	3	(*)
CB1000R	08' - 10'	SPORT	4673	350 x 340		3	(*) (*)
CB1000R	11' - 16'	SPORT	5645	350 x 340		3	(*)
CB1000R NEO SPORTS CAFE	18' - 20'	SPORT	9748	348 x 290	+190	3	(*)
CMX 500 REBEL	17' - 20'	SPORT	3829	325 x 320	+150	3	(*)
CMX 500 REBEL	17' - 20'	TOURING	9462	420 x 360	+200	4	(*)
CMX 300 REBEL	17' - 20'	SPORT	3829	325 x 320	+150	3	(*)
CMX 300 REBEL	17' - 20'	TOURING	9462	420 x 360	+200	4	(*)
CTX700N	14' - 16'	SPORT	7009	400 x 320		4	(*)
HUSQVARNA							
701 ENDURO	16' - 20'	SPORT	9867	350 x 280	+200	3	(*)
701 SUPERMOTO	15' - 20'	SPORT	9867	350 x 280	+200	3	(*)
SVARTPILEN 401	17' - 20'	SPORT	9702	320 x 290	+200	3	(*)
SVARTPILEN 701	19' - 20'	SPORT	3858	320 x 290	+150	3	(*)
VITPILEN 401	17' - 20'	SPORT	9702	320 x 290	+200	3	(*)
VITPILEN 701	17' - 19'	SPORT	9750	320 x 290	+175	3	(*)
INDIAN							
FTR 1200	19' - 20'	SPORT	3834	335 x 313	+130	4	(*)
FTR 1200S	19' - 20'	SPORT	3834	335 x 313	+130	4	(*)

2021 MODELS: www.puig.tv

MODEL	YEAR	TYPE	REF.	DIMENSIONS (Height x Width)	HEIGHT (mm) Compared to OEM	THICKNESS (mm)	R T G V A N W H F C
SCOUT	15' - 20'	TOURING ADJUSTABLE	9386	500 x 375		4	(*)
SCOUT 100 ANNIVERSARY EDITION	20'	TOURING	9386	500 x 375		4	(*)
KAWASAKI							
ER-6N	09' - 11'	SPORT	4950	300 x 255		3	(*) (*)
ER-6N	12' - 16'	SPORT	5997	360 x 330	+95	3	(*) (*)
VULCAN S	15' - 20'	SPORT	3175	310 x 330	+80	4	(*)
VULCAN S	15' - 20'	TOURING	8164	470 x 415	+210	4	(*)
VULCAN S CAFÉ	17' - 20'	SPORT	3175	310 x 330	+80	4	(*)
VULCAN S CAFE	17' - 20'	TOURING	8164	470 x 415	+210	4	(*)
Z125	19' - 20'	SPORT	3494	270 x 240	+90	3	(*)
Z250SL	15' - 16'	SPORT	7656	360 x 300		3	(*) (*)
Z300	15' - 17'	SPORT	7657	310 x 305		3	(*) (*)
Z400	19' - 20'	SPORT	3548	398 x 230	+125	3	(*)
Z650	17' - 19'	SPORT	9588	340 X 220		3	(*) (*)
Z650	17' - 19'	TOURING	9369	460 X 265		3	(*) (*)
Z650	20'	SPORT	3864	330 x 230	+80	3	(*) (*)
Z650	20'	TOURING	3865	425 x 300	+180	3	(*)
Z750	07' - 12'	SPORT	4523	370 x 295			(*)
Z750R	11' - 12'	SPORT	4523	370 x 295			(*)
Z800	13' - 16'	SPORT	6401	390 x 270	+200	3	(*) (*)
Z800E	13' - 16'	SPORT	6401	390 x 270	+200	3	(*) (*)
Z900	17' - 19'	SPORT	9689	385 x 235		3	(*) (*)
Z900	17' - 19'	TOURING	9392	395 x 250		3	(*) (*)
Z900	20'	SPORT	3840	330 x 230	+70	3	(*) (*)
Z900	20'	TOURING	3841	425 x 300	+170	3	(*)
Z1000	10' - 13'	SPORT	5254	425 x 300		3	(*) (*)
Z1000	14' - 20'	SPORT	7011	355 x 215	+65	3	(*) (*)
Z1000	14' - 20'	TOURING	7514	430 x 250	+115	3	(*) (*)
Z1000R	17' - 20'	SPORT	7011	355 x 215	+65	3	(*) (*)
Z1000R	17' - 20'	TOURING	7514	430 x 250	+115	3	(*) (*)
KTM							
125 DUKE	11' - 16'	SPORT	6275	250 x 245		3	(*)
125 DUKE	17' - 20'	SPORT	9514	415 x330	+180	3	(*)
200 DUKE	12' - 15'	SPORT	6275	250 x 245		3	(*)
390 DUKE	13' - 16'	SPORT	6275	250 x 245		3	(*)
390 DUKE	17' - 20'	SPORT	9514	415 x330	+180	3	(*)
690 DUKE	08' - 11'	SPORT	4941	410 x 355		3	(*)
690 DUKE	12' - 20'	SPORT	6009	265 x 265	+210	3	(*)
690 DUKE R	10' - 11'	SPORT	4941	410 x 355		3	(*)
690 DUKE R	12' - 17'	SPORT	6009	265 x 265		3	(*)
690 ENDURO R	19' - 20'	SPORT	3586	315 x 295	+190	3	(*)

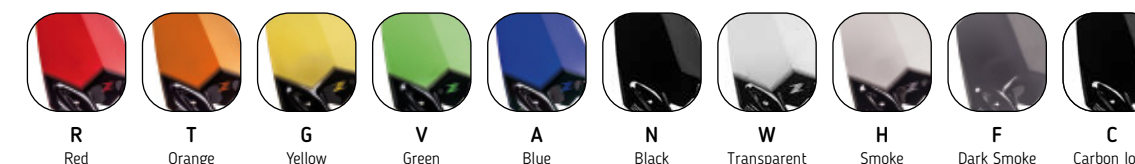

NOTE COLORS: F AND N COLORS DELIVERED WITHOUT SILK PRINT.

(-) Adjustable in width and height.
 (*) Check price with your distributor.
 (#) Only compatible with Triumph Bonneville Bobber with 41 mm. fork.
 (#) This windshield is not compatible with this model Bonneville Bobber Black with 47mm Fork.

IMPORTANT: Indicate code color after part#. Example 0973A

WINDSHIELD SPECIFIC FOR NON-ROUND HEADLIGHTS

HI-TECH PARTS | TYPE OF WINDSCREEN:

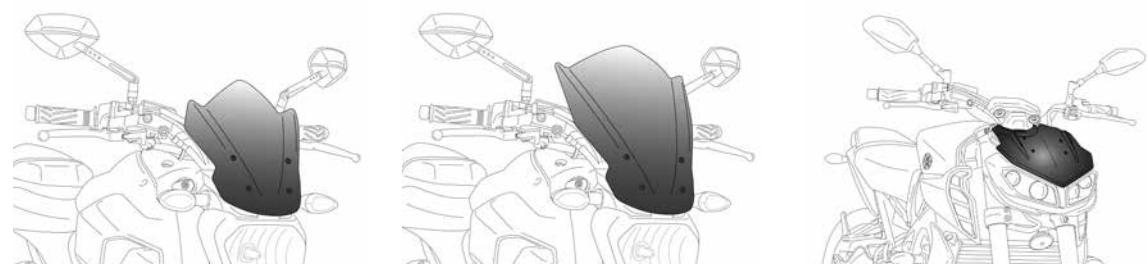

SPORT

TOURING

SPORT PLUS

2021 MODELS: www.puig.tv

MODEL	YEAR	TYPE	REF.	DIMENSIONS (Height x Width)	HEGHT (mm) Compared to OEM	THICKNESS (mm)	R T G V A N W H F C
690 SMC R	19' - 20'	SPORT	3586	315 x 295	+190	3	(*)
790 DUKE	18' - 20'	SPORT	9668	415 x 330	+250	3	(*) (*)
950 SUPERENDURO	06' - 09'	SPORT	5053	310 x 315		3	(*)
950 SUPERMOTO	05' - 07'	SPORT	5053	310 x 315		3	(*)
950 SUPERMOTO R	07' - 08'	SPORT	5053	310 x 315		3	(*)
990 SUPERDUKE	07' - 13'	SPORT	4942	290 x 285		3	(*)
990 SUPERDUKE R	07' - 13'	SPORT	4942	290 x 285		3	(*)
990 SUPERMOTO	08' - 13'	SPORT	5173	285 x 295		3	(*)
990 SUPERMOTO R	09' - 13'	SPORT	5173	285 x 295		3	(*)
1290 SUPERDUKE R	14' - 16'	SPORT	7014	420 x 315	+115	3	(*) (*)
1290 SUPERDUKE R	14' - 16'	SPORT - WITH KIT FOR ORIGINAL GPS SUPPORT	8140	420 x 315	+115		(*) (*)
1290 SUPERDUKE R	17' - 19'	TOURING	9692	415 x 330	+200	3	(*) (*)
1290 SUPERDUKE R	20'	SPORT	20425	265 x 330	+100	3	(*)
1290 SUPERDUKE R	20'	TOURING	20461	415 X 330	+250 to speedometer		(*)
MV AGUSTA							
BRUTALE 675	12' - 18'	SPORT	6010	310 x 315	+170	3	(*)
BRUTALE 800	16' - 20'	SPORT	9011	265 X 305		3	(*) (*)
RIVALE 800	13' - 18'	SPORT	6499	310 x 315	+170	3	(*)
SUZUKI							
B-KING	08' - 11'	SPORT	4630	380 x 330		3	(*) (*)
GSF1250 BANDIT	09' - 11'	SPORT	5027	330 x 390		3	(*)
GSF1250 BANDIT	10' - 13'	SPORT	5027	330 x 390		3	(*)
GSR600	06' - 11'	SPORT	4117	340 x 280		3	(*)
GSR750	11' - 16'	SPORT	5646	320 x 300		3	(*)
GSX-S125	17' - 20'	SPORT	9873	295 x 250	+100	3	(*)
GSX-S750	17' - 20'	SPORT	9435	330 x 240		3	(*) (*)
GSX-S750	17' - 20'	TOURING	9436	440 x 315		3	(*)
GSX-S1000	15' - 20'	SPORT	7653	320 x 260	+175	3	(*) (*)
INAZUMA	13' - 17'	SPORT	6251	320 x 260		3	(*)
SFV650 GLADIUS	09' - 15'	SPORT	4951	300 x 255		3	(*) (*)
TRIUMPH							
BONNEVILLE BOBBER	17' - 20'	TOURING	9437 (#)	275 x 215	+170	4	(*)

2021 MODELS: www.puig.tv

MODEL	YEAR	TYPE	REF.	DIMENSIONS (Height x Width)	HEGHT (mm) Compared to OEM	THICKNESS (mm)	R T G V A N W H F C
ROCKET 3	20'	TOURING	20283	375 x 360	+110	4	(*)
SPEED TRIPLE	05' - 10'	SPORT	3930	280 x 380		3	(*)
SPEED TRIPLE	11' - 15'	SPORT	5658	355 x 270	+110	3	(*) (*)
SPEED TRIPLE	16' - 20'	SPORT	8929	320 x 320		3	(*) (*)
SPEED TRIPLE R	12' - 15'	SPORT	5658	355 x 270		3	(*) (*)
SPEED TRIPLE R	16' - 18'	SPORT	8929	320 x 320		3	(*) (*)
SPEED TRIPLE S/RS	19' - 20'	SPORT	8929	320 x 320		3	(*) (*)
STREET TRIPLE	07' - 10'	SPORT	3930	280 x 380		3	(*)
STREET TRIPLE	13' - 16'	SPORT	5658	355 x 270		3	(*) (*)
STREET TRIPLE	17' - 20'	SPORT	8929	320 x 320		3	(*) (*)
STREET TRIPLE R	08' - 10'	SPORT	3930	280 x 380		3	(*)
STREET TRIPLE R	13' - 15'	SPORT	5658	355 x 270		3	(*) (*)
STREET TRIPLE R	17' - 19'	SPORT	8929	320 x 320		3	(*) (*)
STREET TRIPLE RS	17' - 19'	SPORT	8929	320 x 320		3	(*) (*)
STREET TRIPLE S	17' - 19'	SPORT	9999	310 x 330	+120	3	(*)
STREET TRIPLE S	20'	SPORT	20432	310 x 330	+150		(*)
YAMAHA							
FZ1	06' - 15'	SPORT	4119	320 x 330		3	(*)
FZ6 S2	07' - 10'	SPORT	4511	350 x 370		3	(*)
FZ8	10' - 16'	SPORT	5872	300 x 290		3	(*)
MT-125	14' - 19'	SPORT	7654	320 x 260		3	(*) (*)
MT-125	20'	SPORT	3879	303 x 270	+70	4	(*)
MT-03	16' - 19'	TOURING	8932	330 x 280	+170	3	(*) (*)
MT-03	20'	SPORT	20285	303 x 270	+70	4	(*)
MT-07	14' - 17'	SPORT	7015	295 x 250	+180	3	(*) (*)
MT-07	14' - 17'	TOURING	7016	380 x 300	+260	3	(*)
MT-07	18' - 20'	SPORT	9666	230 x 235	+100	3	(*) (*)
MT-07	18' - 20'	TOURING	9667	360 x 288	+230	3	(*)
MT-07	18' - 20'	SPORTPLUS	1439	220 x 235			(*)
MT-09	13' - 16'	SPORT	6859	290 x 300		3	(*) (*)
MT-09	13' - 16'	TOURING	6861	350 x 290	+60	3	(*)
MT-09	17' - 20'	SPORT	9376	290 x 270		3	(*)
MT-09	17' - 20'	TOURING	9377	420 x 305		3	(*) (*)
MT-09	17' - 20'	SPORTPLUS	9507			3	(*)
MT-09 SP	18' - 20'	SPORT	9376	290 x 270		3	(*)
MT-09 SP	18' - 20'	TOURING	9377	420 x 305		3	(*) (*)
MT-09 SP	18' - 20'	SPORTPLUS	9507			3	(*)
VMAX	09' - 20'	SPORT	4952	420 x 480		3	(*)
XJ6	09' - 16'	SPORT	5026	325 x 270		3	(*) (*)
XV950	14' - 20'	TOURING	9438	420 x 360	+240	4	(*)
XV950R	14' - 20'	TOURING	9438	420 x 360	+240	4	(*)
XV950 RACER	14' - 20'	TOURING	9438	420 x 360	+240	4	(*)

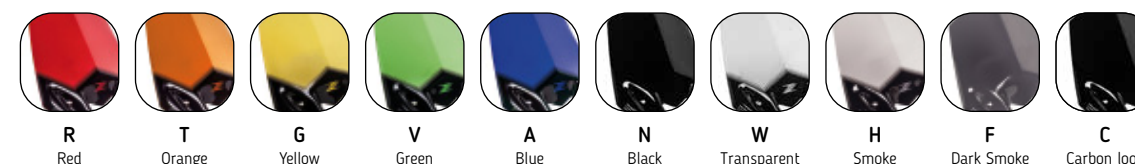

NOTE COLORS: F AND N COLORS DELIVERED WITHOUT SILK PRINT.
 (-) Adjustable in width and height.
 (*) Check price with your distributor.
 (#) Only compatible with Triumph Bonneville Bobber with 41 mm. fork.
 (#) This windshield is not compatible with this model Bonneville Bobber Black with 47mm Fork.
IMPORTANT: Indicate code color after part#. Example 0973A

DOWNFORCE SPOILERS SPORT

HI-TECH PARTS | TECHNICAL SECTION



ANTI-WHEELIE



ANTI SHIMMIE

More stability on straights.



DOWNFORCE

More composure when braking.



STABILITY

More stability when changing direction.



REF. 3162V

They consist of:

- Set of spoilers made of 4mm thick CN High-Impact acrylic. Always in black.
- Set of deflectors available in colors.



Puig's Downforce Sport spoilers have been developed thanks to the experience and tests carried out by the Kawasaki Racing team on the WorldSBK championship circuits. Get the ultimate racing touch and improve the cornering of your motorcycle with these Downforce Sport spoilers.



A
Blue

N
Black

R
Red

V
Green

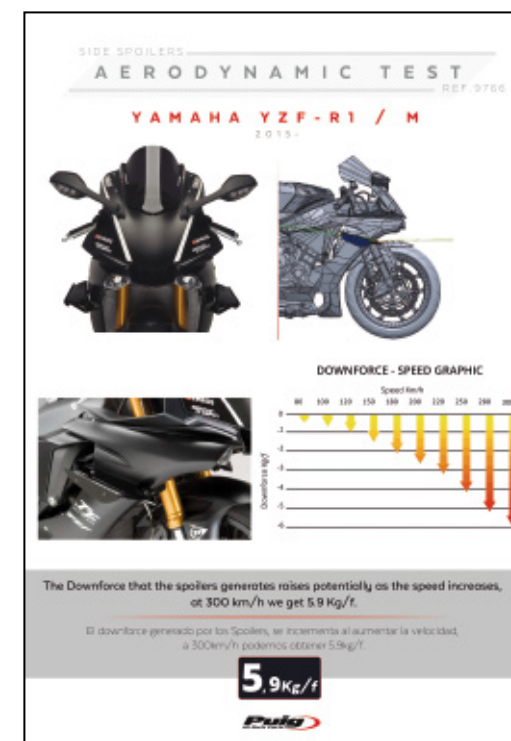

Aerodynamic test supplied along most of our spoilers.

FOR SPECIFIC MODELS SEE PAGE 118.

DOWNFORCE SPOILERS RACE

HI-TECH PARTS | TECHNICAL SECTION



ANTI-WHEELIE



ANTI SHIMMIE

More stability on straights.



DOWNFORCE

More composure when braking.



STABILITY

More stability when changing direction.



REF. 20431F

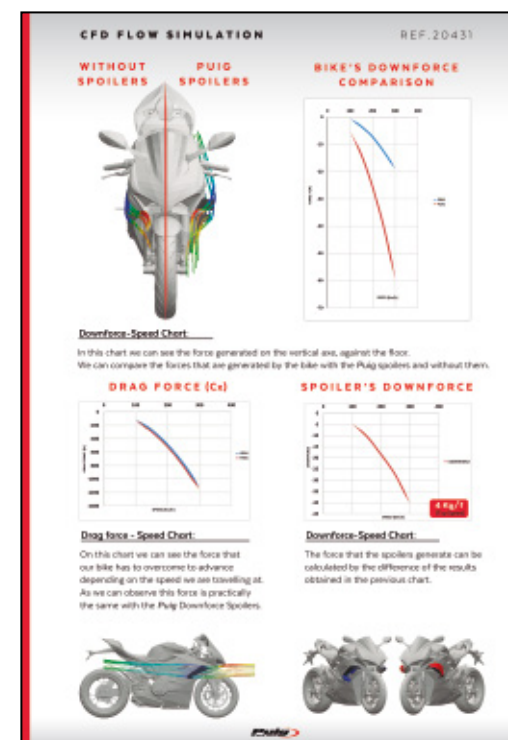

Aerodynamic test supplied along most of our spoilers.

They are made up of two elements:

- Supports injected in flexible black plastic that adapt perfectly to the fairing of your motorcycle by means of a 3M dual lock adhesive, strong, resistant and durable, but that can be removed and does not damage or require holes in your fairing.
- Spoiler in closed form, which is made of 4 mm. acrylic material. To choose a color, following safety regulations, with rounded edges with a radius >2 mm., a highly rigid and light material that is perfect for receiving aerodynamic pressure and directly translating it into downforce.



This product, extracted from the experience of the brand in the Moto GP championship, manages to provide greater air pressure in the front end in high-speed sections and improve cornering.



F
Dark Smoke

N
Black

R
Red

FOR SPECIFIC MODELS SEE PAGE 118.

DOWNFORCE SPOILERS NAKED

HI-TECH PARTS | TECHNICAL SECTION



ANTI-WHEELIE



ANTI SHIMMIE

More stability on straights.



DOWNFORCE

More composure when braking.



STABILITY

More stability when changing direction.



REF. 20380R

Naked spoilers are made up of:

- Spoiler-covers in matt black ABS material, which are easily installed on your motorcycle by means of metal supports with an anti-corrosion finish in black, light and resistant.
- Deflectors, which are made of 4 mm. thick CN acrylic material and a color to choose from (colors defined according to models). These deflectors have a rounded Ø 4 mm. edge for greater rider safety.



The NAKED spoilers are an adaptation of the most cutting-edge innovations in competition in the field of aerodynamics applied to your motorcycle, providing it with the best performance and an incomparable sport style. Designed and manufactured in Barcelona with the most advanced technologies to achieve a technical product with the best aesthetics and finishes



A Blue **N** Black **R** Red **V** Green **T** Orange

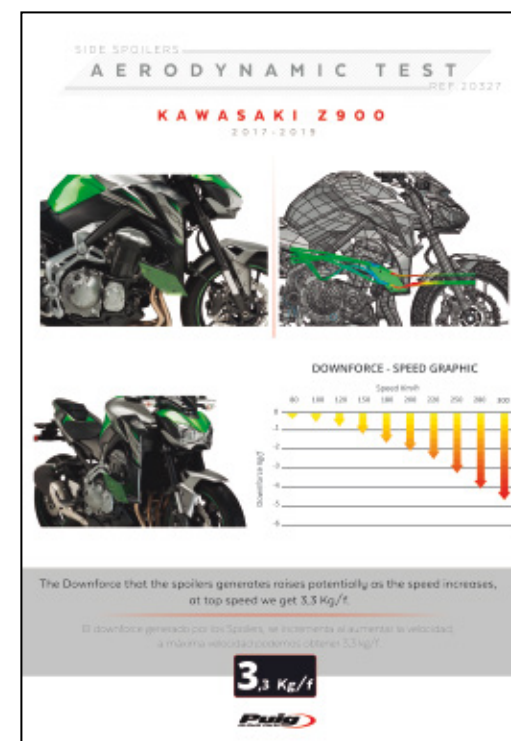

Aerodynamic test supplied along most of our spoilers.

DOWNFORCE SPOILERS

HI-TECH PARTS | TYPE OF DOWNFORCE SPOILERS:

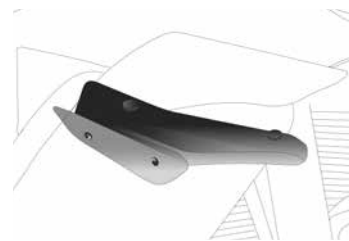

DOWNFORCE SPOILERS SPORT

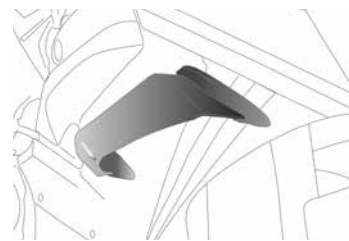

DOWNFORCE SPOILERS RACE

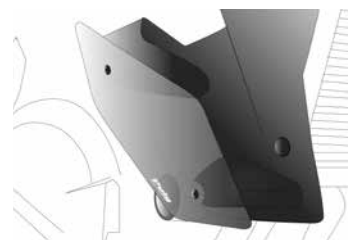

DOWNFORCE SPOILERS NAKED

2021 MODELS: www.puig.tv

MODEL	YEAR	TYPE	REF.	A F N R V T
APRILIA				
RSV4 RF/RR	15' - 20'	SPORT	2334	(*)
BMW				
S1000RR	15' - 18'	SPORT	9767	(*)
S1000RR	19' - 20'	SPORT	3636	(*)
DUCATI				
899 PANIGALE	14' - 15'	SPORT	3566	(*)
959 PANIGALE	16' - 20'	SPORT	3165	(*)
959 PANIGALE CORSE	18' - 20'	SPORT	3165	(*)
1199 PANIGALE/S	12' - 15'	SPORT	3566	(*)
1199 PANIGALE R	15' - 17'	SPORT	3566	(*)
1299 PANIGALE/S	15' - 17'	SPORT	3165	(*)
PANIGALE V2	20'	RACE	20431	(*)
PANIGALE 1100 V4	20'	RACE	20431	(*)
PANIGALE 1100 V4S	20'	RACE	20431	(*)
HONDA				
CBR500R	19' - 20'	SPORT	3614	(*)
CBR650R	19' - 20'	SPORT	3569	(*)
CBR600RR	13' - 16'	SPORT	3161	(*)
CBR1000RR FIREBLADE/SP/SP2	17' - 19'	SPORT	9729	(*)
KAWASAKI				
NINJA 400	18' - 20'	SPORT	3172	(*)
NINJA 650	17' - 19'	SPORT	3835	(*)
NINJA 650	20'	SPORT	3882	(*)
NINJA H2	15' - 20'	SPORT	3658	(*)
NINJA H2 SX	18' - 20'	SPORT	3658	(*)
Z650	20'	NAKED	20328	(*)
Z900	17' - 19'	NAKED	20327	(*)
Z900	20'	NAKED	20284	(*)
ZX-6R	09' - 16'	SPORT	3162	(*)
ZX-6R 636	13' - 16'	SPORT	3162	(*)

2021 MODELS: www.puig.tv

MODEL	YEAR	TYPE	REF.	A F N R V T
ZX-6R 636	19' - 20'	SPORT	3176	(*)
ZX-10R	11' - 15'	SPORT	9882	(*)
ZX-10R	16' - 20'	SPORT	9882	(*)
ZX-10RR	17' - 20'	SPORT	9882	(*)
ZX-10R SE	18' - 20'	SPORT	9882	(*)
KTM				
1290 SUPERDUKE R	20'	NAKED	20462	(*)
MV AGUSTA				
F3 675	11' - 20'	SPORT	3173	(*)
F3 800	13' - 20'	SPORT	3173	(*)
SUZUKI				
GSX-R600/750	11' - 16'	SPORT	3163	(*)
GSX-R1000/R	17' - 20'	SPORT	9738	(*)
YAMAHA				
MT-07	18' - 20'	NAKED	20381	(*)
MT-09	17' - 20'	NAKED	20380	(*)
MT-09 SP	18' - 20'	NAKED	20380	(*)
YZF-R1	15' - 19'	SPORT	9766	(*)
YZF-R1	20'	SPORT	20297	(*)
YZF-R1 M	17' - 19'	SPORT	9766	(*)
YZF-R1 M	20'	SPORT	20297	(*)
YZF-R3	15' - 18'	SPORT	3171	(*)
YZF-R3	19' - 20'	SPORT	3739	(*)
YZF-R6	17' - 20'	SPORT	1946	(*)

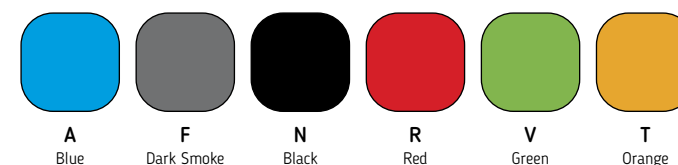

(*) Check price with your distributor.

IMPORTANT: Indicate code color after part#. Example 0973A

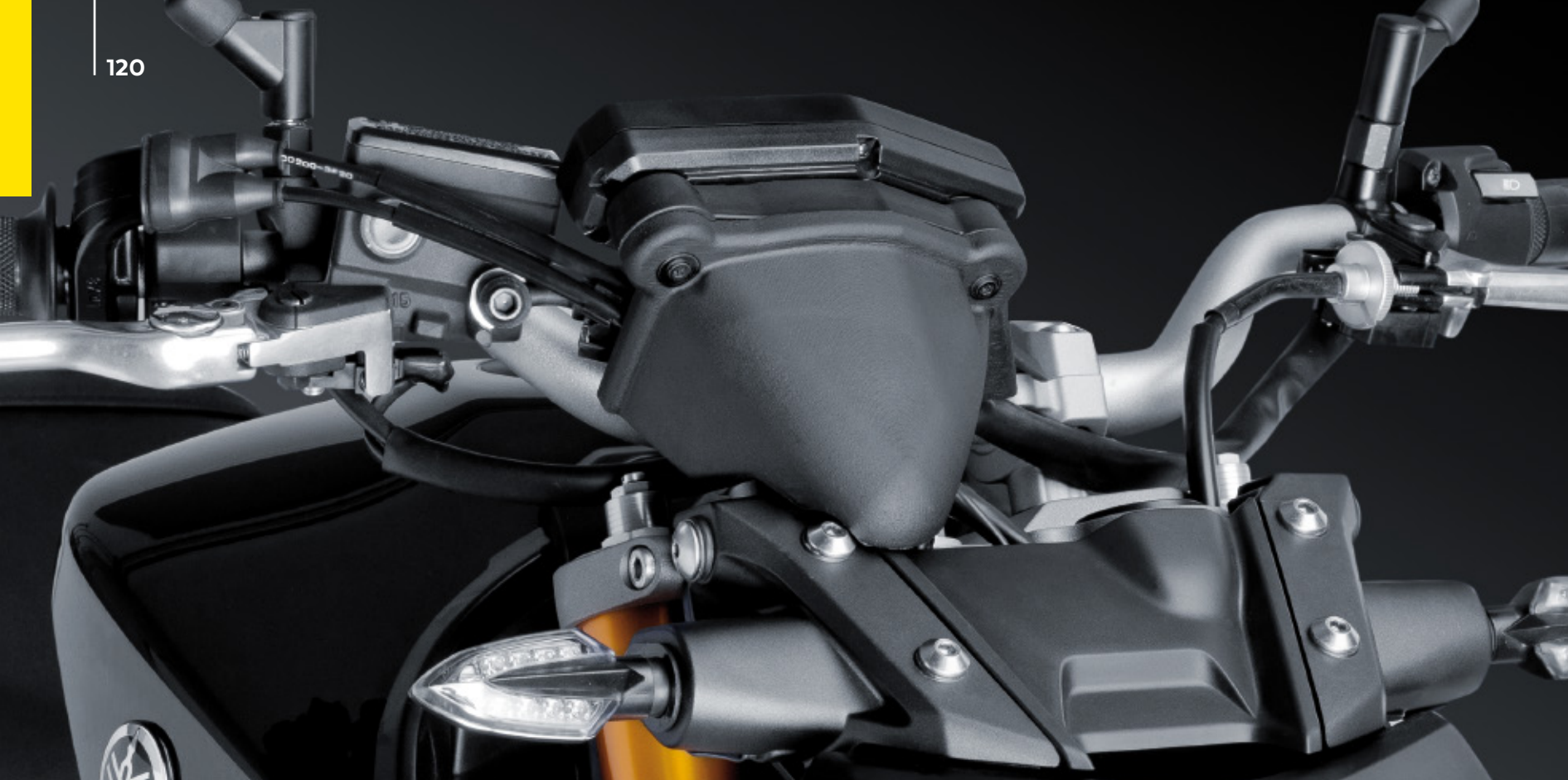

CLOCK TOPS

HI-TECH PARTS | TECHNICAL SECTION

MODEL	YEAR	REF.	J	C
YAMAHA				
MT-09	13' - 16'	7515	(*)	(*)

REF. 7515

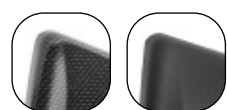

C Carbon look
J Matt black

(*) Check price with your distributor.
IMPORTANT: Indicate code color after part#. Example 0973A



FRONTAL DEFLECTOR SCREENS

HI-TECH PARTS | TECHNICAL SECTION

MODEL	YEAR	REF.	W	H	F	N
HONDA						
CRF1100L AFRICA TWIN ADVENTURE SPORTS	20'	3823				(*)
YAMAHA						
MT-07 TRACER	16' - 18'	9226				(*)
MT-07 TRACER GT	19'	9226				(*)
MT-09 TRACER	15' - 17'	9225				(*)

REF. 9225



N Black
W Transparent
H Smoke
F Dark Smoke

(*) Check price with your distributor.
IMPORTANT: Indicate code color after part#. Example 0973A

UPPER DEFLECTORS

HI-TECH PARTS | TECHNICAL SECTION

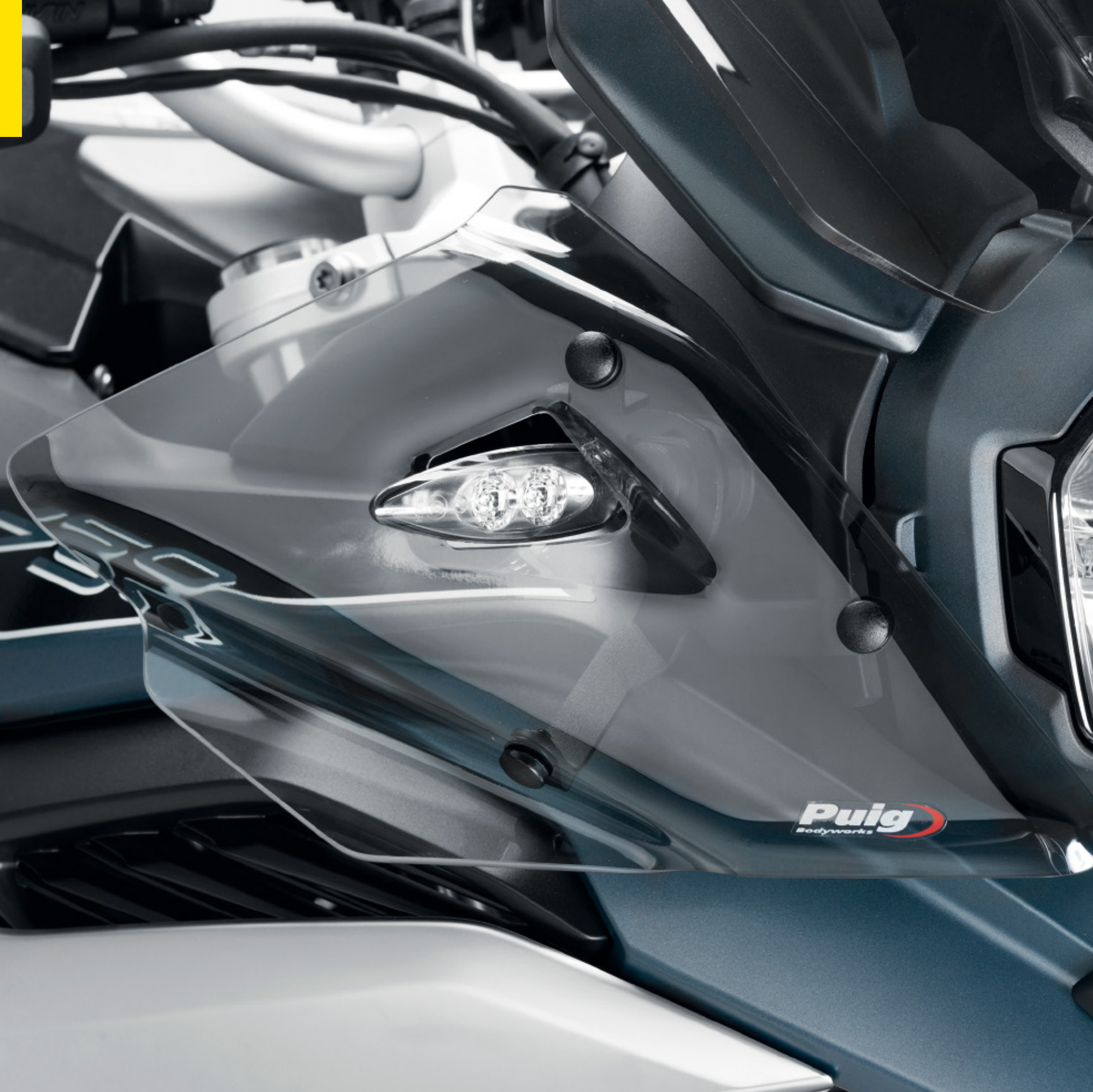

REF. 9847

MODEL	YEAR	REF.	W	H	F
BMW					
F750GS	18' - 20'	9847			(*)
F850GS	18' - 20'	9847			(*)
F850GS ADVENTURE	19' - 20'	9847			(*)
F900XR	20'	20430			(*)
R1200GS	13' - 18'	9847			(*)
R1200GS EXCLUSIVE	17' - 18'	9847			(*)
R1200GS RALLYE	17' - 18'	9847			(*)
R1250GS	18' - 20'	9847			(*)
KTM					
1090 ADVENTURE/R	17' - 20'	9623			(*)
1290 SUPER ADVENTURE R/S	17' - 20'	9623			(*)
1290 SUPER ADVENTURE T	17'	9623			(*)
TRIUMPH					
TIGER 900	20'	20420			(*)
TIGER 900 GT	20'	20420			(*)
TIGER 900 GT LOW	20'	20420			(*)
TIGER 900 GT PRO	20'	20420			(*)
TIGER 900 RALLY	20'	20420			(*)
TIGER 900 RALLY PRO	20'	20420			(*)

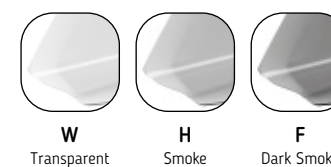

W Transparent H Smoke F Dark Smoke

(*) Check price with your distributor.
IMPORTANT: Indicate code color after part#. Example: 0973A.

NEW!



// SHARK

MODEL	REF.	PRICE
SHARK UNIVERSAL HANDLEBARS 22/26	20334	(*)

(*) Check price with your distributor.

IMPORTANT: Indicate code color after part#. Example 0973A

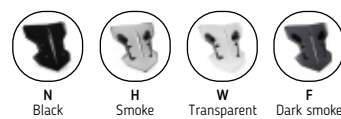
Check availability for motorcycle models at www.puig.tv typing in the searching window

N Black
H Smoke
W Transparent
F Dark smoke

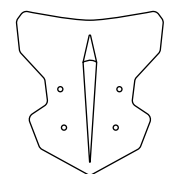

270 mm

2 FIXATION POINTS

303 mm



// BAT

MODEL	REF.	PRICE
BAT UNIVERSAL HANDLEBARS 22/26	8088	(*)

(*) Check price with your distributor.

IMPORTANT: Indicate code color after part#. Example 0973A

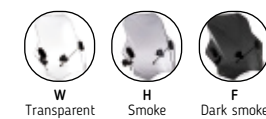
Check availability for motorcycle models at www.puig.tv typing in the searching window

W Transparent
H Smoke
F Dark smoke

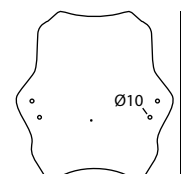

390 mm

2 FIXATION POINTS

430 mm



// RAFALE

MODEL	REF.	PRICE
RAFALE UNIVERSAL HANDLEBARS 22/26	5881	(*)

(*) Check price with your distributor.

IMPORTANT: Indicate code color after part#. Example 0973A

Check availability for motorcycle models at www.puig.tv typing in the searching window



TÜV

ABE
58188



2 FIXATION POINTS



// UP&DOWN

MODEL	REF.	PRICE
UP&DOWN UNIVERSAL HANDLEBARS 22/26	2193	(*)

(*) Check price with your distributor.

IMPORTANT: Indicate code color after part#. Example 0973A

Check availability for motorcycle models at www.puig.tv typing in the searching window



H
Smoke



W
Transparent

TÜV

ABE
58007

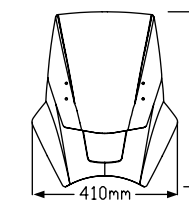

2 FIXATION POINTS



// TREND

MODEL	REF.	PRICE
TREND UNIVERSAL HANDLEBARS 22/26	5022	(*)

(*) Check price with your distributor.

IMPORTANT: Indicate code color after part#. Example 0973A

Check availability for motorcycle models at www.puig.tv typing in the searching window

TREND



A

Blue

N

Black



H

Smoke

F

Dark smoke

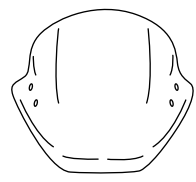

410 mm

2 FIXATION POINTS

320 mm



// TREND WITH VISOR

MODEL	REF.	PRICE
TREND WITH VISOR UNIVERSAL HANDLEBARS 22/26	5920	(*)

(*) Check price with your distributor.

IMPORTANT: Indicate code color after part#. Example 0973A

Check availability for motorcycle models at www.puig.tv typing in the searching window

TREND VISOR



H

Smoke

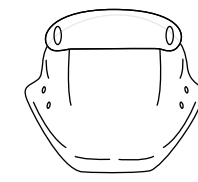

410 mm

2 FIXATION POINTS

320 mm



// TOURING II

MODEL	REF.	W	H
TOURING II UNIVERSAL HANDLEBARS 22/26	5267	(*)	(*)

(*) Check price with your distributor.

IMPORTANT: Indicate code color after part#. Example 0973A

Check availability for motorcycle models at www.puig.tv typing in the searching window



H
Smoke



W
Transparent

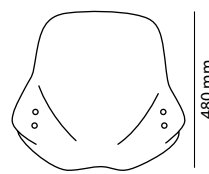

535 mm

2 FIXATION POINTS



// NAKED

MODEL	REF.	PRICE
UNIVERSAL	0869	(*)

(*) Check price with your distributor.

IMPORTANT: Indicate code color after part#. Example 0973A

Check availability for motorcycle models at www.puig.tv typing in the searching window



A
Blue



N
Black



H
Smoke



F
Dark smoke

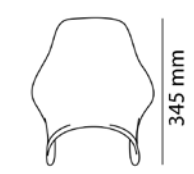

320 mm

2 FIXATION POINTS



// RAPTOR

MODEL	REF.	A	R	H	N	W	F
UNIVERSAL	0013						

OPTIMUM MOUNTING FOR HEADLIGHTS Ø 200 mm.

(*) Check price with your distributor.

Check availability for motorcycle models at www.puig.tv typing in the searching window

R Red A Blue N Black



W Transparent H Smoke F Dark smoke



ABE
58188



355 mm

2 FIXATION POINTS



// COCKPIT

MODEL	REF.	A	R	H	N	W	F	G
UNIVERSAL	1480							

OPTIMUM MOUNTING FOR HEADLIGHTS Ø 200 mm.

(*) Check price with your distributor.

Check availability for motorcycle models at www.puig.tv typing in the searching window

R Red G Yellow A Blue N Black



W Transparent H Smoke F Dark smoke



ABE
58188



355 mm

2 FIXATION POINTS



// WAVE

MODEL	REF.	A	R	H	N	F
UNIVERSAL	2208					(*)

OPTIMUM MOUNTING FOR HEADLIGHTS Ø 200 mm.

(*) Check price with your distributor.

Check availability for motorcycle models at www.puig.tv typing in the searching window

R Red
A Blue
N Black



H Smoke
F Dark smoke



TÜV



ABE 58188

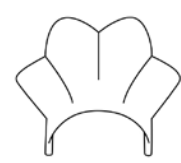

375 mm

325 mm

2 FIXATION POINTS



// TRACK

MODEL	REF.	A	R	H	N	W	F	G	Y
UNIVERSAL	4120								(*)

OPTIMUM MOUNTING FOR HEADLIGHTS Ø 200 mm.

(*) Check price with your distributor.

Check availability for motorcycle models at www.puig.tv typing in the searching window

R Red
G Yellow
A Blue
N Black



H Smoke
F Dark smoke
Y Iridium



TÜV



ABE 58188



310 mm

365 mm

2 FIXATION POINTS



// WINDY

MODEL	REF.	PRICE
UNIVERSAL	1482	(*)

OPTIMUM MOUNTING FOR HEADLIGHTS Ø 200 mm.

(*) Check price with your distributor.

Check availability for motorcycle models at www.puig.tv typing in the searching window

WINDY



R Red A Blue N Black



W Transparent H Smoke F Dark smoke



355 mm

2 FIXATION POINTS

315 mm



// VISION

MODEL	REF.	PRICE
UNIVERSAL	003CX	(*)
UNIVERSAL	003NX	(*)

Check availability for motorcycle models at www.puig.tv typing in the searching window

VISION

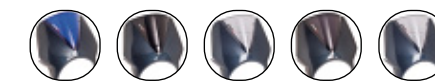

CA Blue CN Black CH Smoke CF Dark smoke CW Transparent

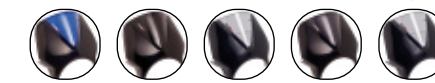

NA Blue NN Black NH Smoke NF Dark smoke NW Transparent



310 mm

2 FIXATION POINTS

330 mm



// TOP

MODEL	REF.	PRICE
UNIVERSAL	1309	(*)

OPTIMUM MOUNTING FOR HEADLIGHTS Ø 200 mm.

(*) Check price with your distributor.

Check availability for motorcycle models at www.puig.tv typing in the searching window

TOP



N

Black



H

Smoke



TÜV

ABE

58188

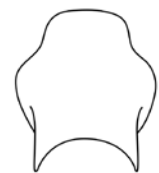

355 mm

390 mm

2 FIXATION POINTS



// PLUS

MODEL	REF.	PRICE
UNIVERSAL	4620	(*)

OPTIMUM MOUNTING FOR HEADLIGHTS Ø 200 mm.

(*) Check price with your distributor.

Check availability for motorcycle models at www.puig.tv typing in the searching window

PLUS



F

Dark smoke



H

Smoke



TÜV

ABE

58188

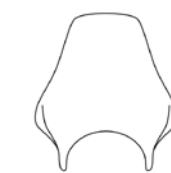

405 mm

430 mm

2 FIXATION POINTS



// CUSTOM I

MODEL	REF.	PRICE
UNIVERSAL HANDLEBARS 22/26 mm. FORKS 38/42 mm.	0840	(*)

(*) Check price with your distributor.

Check availability for motorcycle models at www.puig.tv typing in the searching window
W
TransparentH
Smoke

360 mm

4 FIXATION POINTS



// CUSTOM II

MODEL	REF.	PRICE
UNIVERSAL HANDLEBARS 22/26 mm.	0336	(*)

(*) Check price with your distributor.

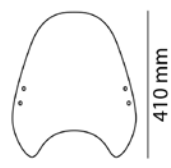
IMPORTANT: Indicate code color after part#. Example 0973ACheck availability for motorcycle models at www.puig.tv typing in the searching window
W
TransparentH
Smoke

360 mm

2 FIXATION POINTS



// CUSTOM II WITH VISOR

MODEL	REF.	PRICE
UNIVERSAL HANDLEBARS 22/26 mm.	5921	(*)

(*) Check price with your distributor.

IMPORTANT: Indicate code color after part#. Example 0973A

Check availability for motorcycle models at www.puig.tv typing in the searching window



H
Smoke

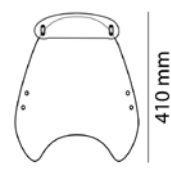

360 mm

2 FIXATION POINTS



// RANGER

MODEL	REF.	PRICE
UNIVERSAL HANDLEBARS 22/26 mm. FORKS 38/42 mm.	0328	(*)

(*) Check price with your distributor.

Check availability for motorcycle models at www.puig.tv typing in the searching window



H
Smoke



510 mm

4 FIXATION POINTS



// TOURING I

MODEL	REF.	PRICE
UNIVERSAL HANDLEBARS 22/26 mm.	0856	(*)

(*) Check price with your distributor.

IMPORTANT: Indicate code color after part#. Example 0973A

Check availability for motorcycle models at www.puig.tv typing in the searching window

 TOURING I



W
Transparent



540 mm

530 mm

2 FIXATION POINTS



// ROADSTER

MODEL	REF.	PRICE
UNIVERSAL A	0444	(*)
UNIVERSAL B	0131	(*)
UNIVERSAL C	5932	(*)

FIXINGS TO THE FORK BARS

FIXATIONS ON LIGHT SCREWS

FIXINGS TO THE HANDLE OF 22/26 mm.



W
Transparent



H
Smoke

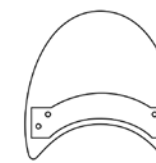

260 mm

290 mm

2 FIXATION POINTS

Check availability for motorcycle models at www.puig.tv typing in the searching window

 ROADSTER



// CHOPPER

MODEL	REF.	PRICE
UNIVERSAL HANDLEBARS 22/26 mm.	0854	(*)

(*) Check price with your distributor.

IMPORTANT: Indicate code color after part#. Example 0973A

Check availability for motorcycle models at www.puig.tv typing in the searching window



W
Transparent



H
Smoke



ABE
38007

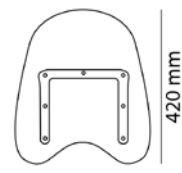

440 mm

2 FIXATION POINTS



// HIGHWAY

MODEL	REF.	W
UNIVERSAL HANDLEBARS 22/26 mm.	0129	(*)

EASY-MOUNTING WINDSHIELD THROUGH 2 HANDLEBAR CLAMPS.
FOR A MORE DEMANDING FIXATION WE RECOMMEND OUR WINDSHIELD MODELS OF 4 POINTS OF FIXING.

Check availability for motorcycle models at www.puig.tv typing in the searching window



W
Transparent



ABE
38007

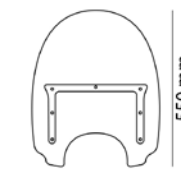

455 mm

2 FIXATION POINTS



// DAYTONA IV

MODEL	REF.	PRICE
UNIVERSAL HANDLEBARS 22/26 mm.	2003	(*)

EASY-MOUNTING WINDSHIELD THROUGH 2 HANDLEBAR CLAMPS.
FOR A MORE DEMANDING FIXATION WE RECOMMEND OUR WINDSHIELD MODELS OF 4 POINTS OF FIXING.

Check availability for motorcycle models at www.puig.tv typing in the searching window

 DAYTONA IV



W
Transparent



410 mm

2 FIXATION POINTS



// DAYTONA III

MODEL	REF.	PRICE
UNIVERSAL HANDLEBARS 22/26 mm.	1984	(*)

EASY-MOUNTING WINDSHIELD THROUGH 2 HANDLEBAR CLAMPS.
FOR A MORE DEMANDING FIXATION WE RECOMMEND OUR WINDSHIELD MODELS OF 4 POINTS OF FIXING.

Check availability for motorcycle models at www.puig.tv typing in the searching window

 DAYTONA III



W
Transparent



480 mm

2 FIXATION POINTS



// AMERICA I

MODEL	REF.	PRICE
UNIVERSAL	0867	(*)

(*) Check price with your distributor.

IMPORTANT: Indicate code color after part#. Example 0973A

Check availability for motorcycle models at www.puig.tv typing in the searching window

 AMERICA I



W
Transparent



455 mm

4 FIXATION POINTS

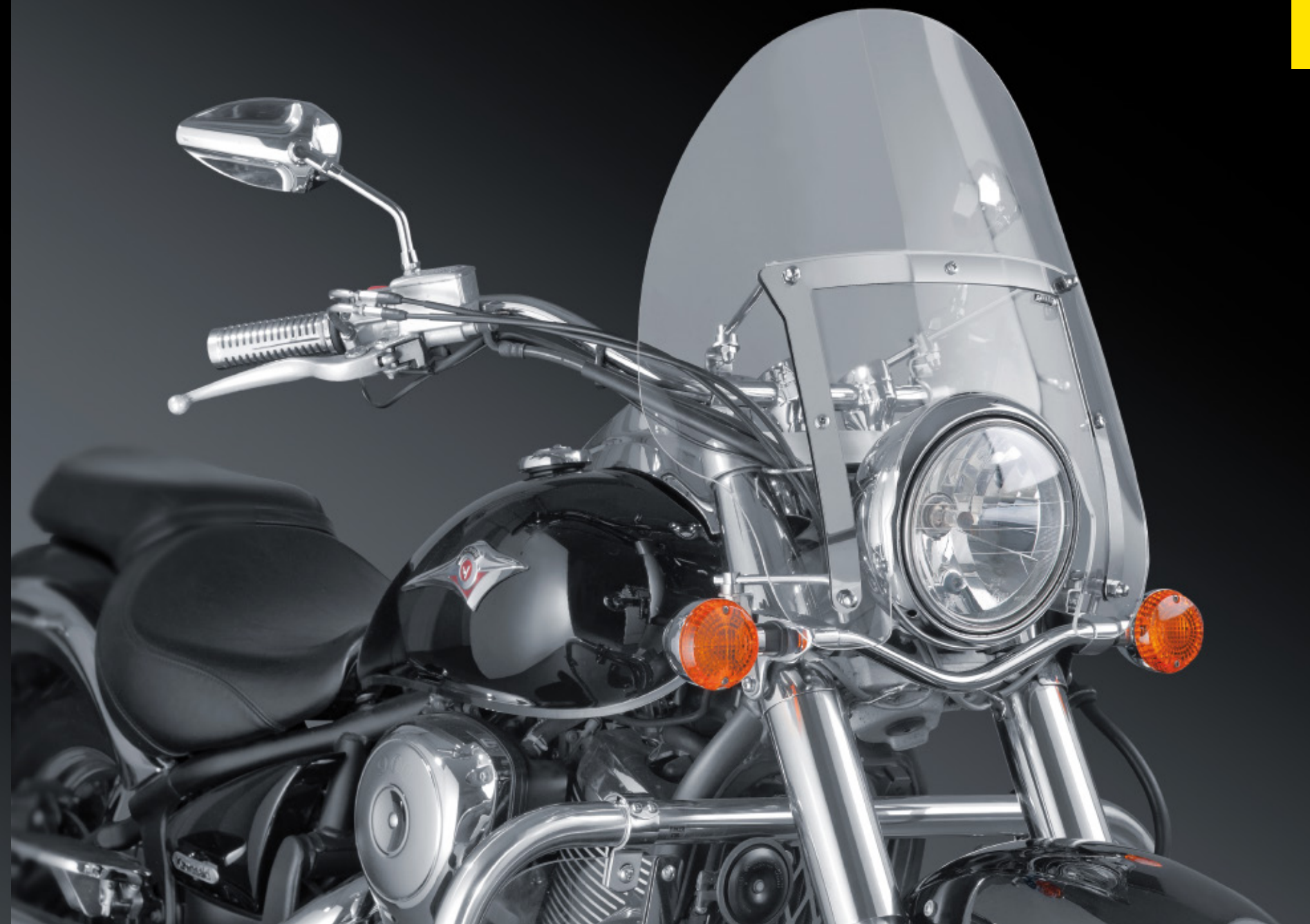

// AMERICA II

MODEL	REF.	PRICE
UNIVERSAL	0319	(*)

(*) Check price with your distributor.

IMPORTANT: Indicate code color after part#. Example 0973A

Check availability for motorcycle models at www.puig.tv typing in the searching window

 AMERICA II



W
Transparent



560 mm

4 FIXATION POINTS



// AMERICA III

MODEL	REF.	PRICE
UNIVERSAL	1129	(*)

(*) Check price with your distributor.

IMPORTANT: Indicate code color after part#. Example 0973A

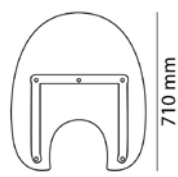
Check availability for motorcycle models at www.puig.tv typing in the searching window
W
Transparent

580 mm

4 FIXATION POINTS

710 mm



// CITY SPORT

MODEL	REF.	PRICE
UNIVERSAL (MIRROR M8)	0661	(*)

(*) Check price with your distributor.

IMPORTANT: Indicate code color after part#. Example 0973A

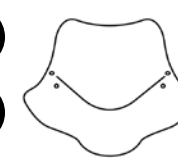
Check availability for motorcycle models at www.puig.tv typing in the searching window
H
Smoke

460 mm

2 FIXATION POINTS

330 mm



// CITY TOURING

MODEL	REF.	PRICE
UNIVERSAL (MIRROR M8)	0572	(*)

(*) Check price with your distributor.
 IMPORTANT: Indicate code color after part#. Example 0973A

Check availability for motorcycle models at www.puig.tv typing in the searching window



H
Smoke



560 mm

460 mm

2 FIXATION POINTS



// TRAFIC

MODEL	REF.	PRICE
UNIVERSAL	4873	(*)

(*) Check price with your distributor.
 IMPORTANT: Indicate code color after part#. Example 0973A

Check availability for motorcycle models at www.puig.tv typing in the searching window



W
Transparent



H
Smoke

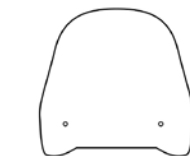

370 mm

310 mm

2 FIXATION POINTS



// URBAN

MODEL	REF.	PRICE
UNIVERSAL	7599	(*)

(*) Check price with your distributor.

IMPORTANT: Indicate code color after part#. Example 0973A

Check availability for motorcycle models at www.puig.tv typing in the searching window



W
Transparent



H
Smoke

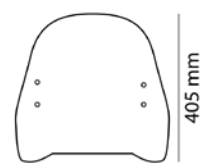

390 mm

2 FIXATION POINTS



// T.S.

MODEL	REF.	PRICE
UNIVERSAL	6371	(*)

(*) Check price with your distributor.

IMPORTANT: Indicate code color after part#. Example 0973A

Check availability for motorcycle models at www.puig.tv typing in the searching window



W
Transparent



480 mm

2 FIXATION POINTS



// T.X.

MODEL	REF.	PRICE
UNIVERSAL	1952	(*)

(*) Check price with your distributor.

IMPORTANT: Indicate code color after part#. Example 0973A

Check availability for motorcycle models at www.puig.tv typing in the searching window



W
Transparent



555 mm

2 FIXATION POINTS



// HAND GUARDS

MODEL	REF.	PRICE
HAND GUARDS UNIVERSAL	6855	(*)

(*) Check price with your distributor.

IMPORTANT: Indicate code color after part#. Example 0973A

Check availability for motorcycle models at www.puig.tv typing in the searching window



W
Transparent



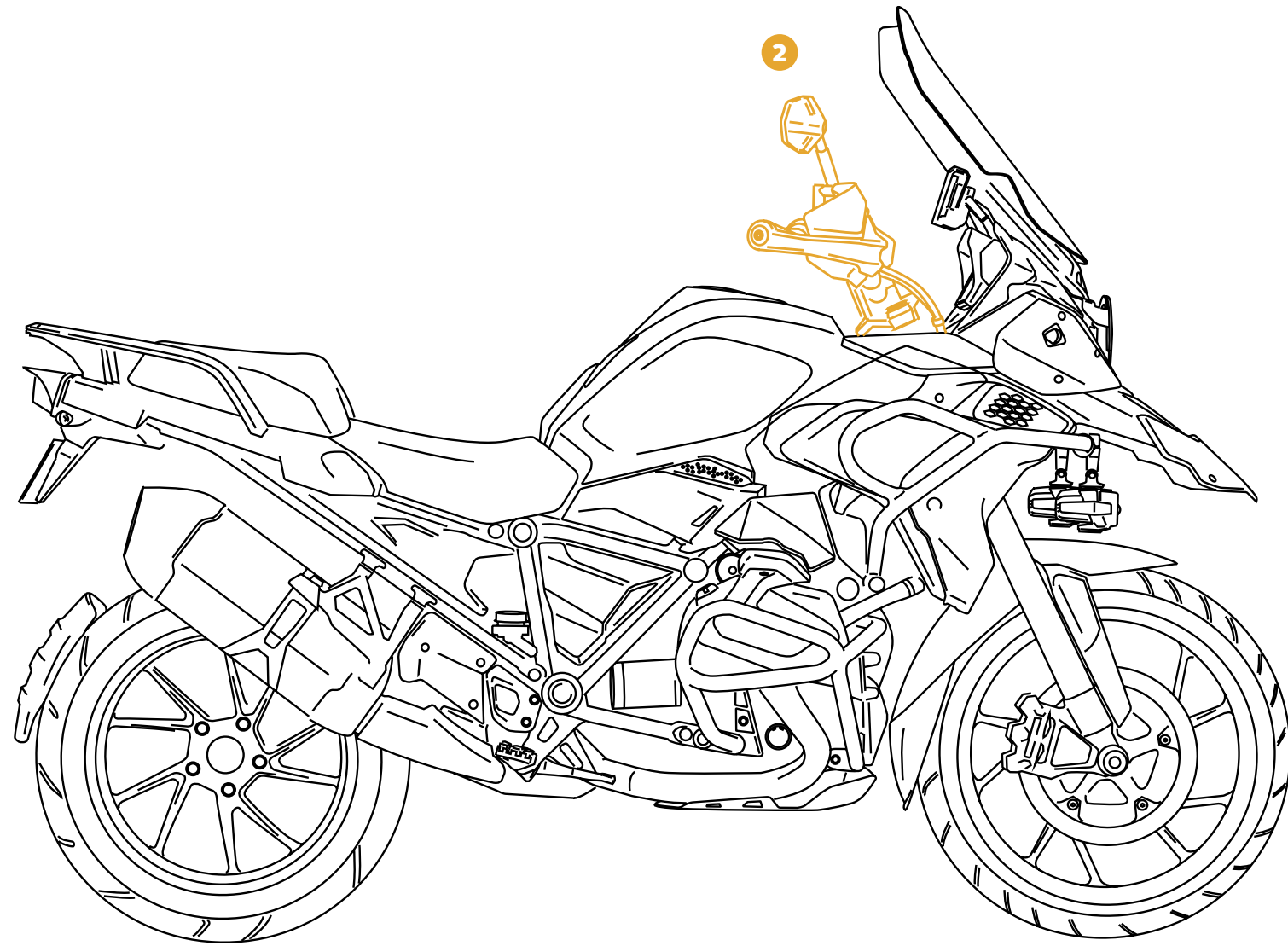

HANDLEBAR AREA

BAR ENDS LONG AND SHORT MODELS	225	OFF-ROAD LEVERS	195
BAR ENDS SHORT WITH RING AND RACE MODELS	227	ORIGINAL REARVIEW MIRRORS LEADS, SUPPORT, FLANGE AND SHIFTER	257
BAR ENDS THRUSTER	223	PARKING BRAKE LEVER	211
BRAKE / CLUTCH LEVER PROTECTOR	183	REARVIEW MIRROR GRAND TRACKER	231
BRAKE / CLUTCH LEVER PROTECTOR ADAPTORS	184	REARVIEW MIRROR HI-TECH IV	235
BRAKE-CLUTCH LIQUID TANK COVER	202	REARVIEW MIRROR LOOK	229
GLOVE FOR FRONT BRAKE TANK	203	REARVIEW MIRROR TRACKER	233
GRIPS ASCENT	215	REARVIEW MIRROR CAPS	259
GRIPS BASIC	221	REARVIEW MIRROR EXPLORER	245
GRIPS RACING	219	REARVIEW MIRROR F1.1	251
GRIPS RADIKAL	217	REARVIEW MIRROR GT.1	247
GRIPS VINTAGE	213	REARVIEW MIRROR GTI	249
HANDLEBAR DEFLECTORS	271	REARVIEW MIRROR HYPERNAKED	243
HANDLEBAR REINFORCEMENT	165	REARVIEW MIRROR MG	255
HANDLEBARS	163	REARVIEW MIRROR MONACO	239
HERITAGE LEVERS	193	REARVIEW MIRROR MP	237
IN-TAKE CHARGE	275	REARVIEW MIRROR MT	254
LEVERS 3.0	167	REARVIEW MIRROR RETRO	241
LEVERS ADAPTERS	170	REARVIEW MIRROR RS1	252
MAXISCOOTER HANDGUARDS	265	REARVIEW MIRROR RS2	253
MOBILE CASE	275	REARVIEW MIRROR Z1	256
MOBILE PHONE SUPPORT	273	RISERS	164
MOBILE SUPPORTS	277	SCOOTER LEVERS	191
MOTORCYCLE HANDGUARD EXTENSIONS	263	THERMAL GLOVES ANTI-VIBRATION	181
MOTORCYCLE HANDGUARDS	261		

HANDLEBARS

HI-TECH PARTS | TECHNICAL SECTION



REF. 7493N

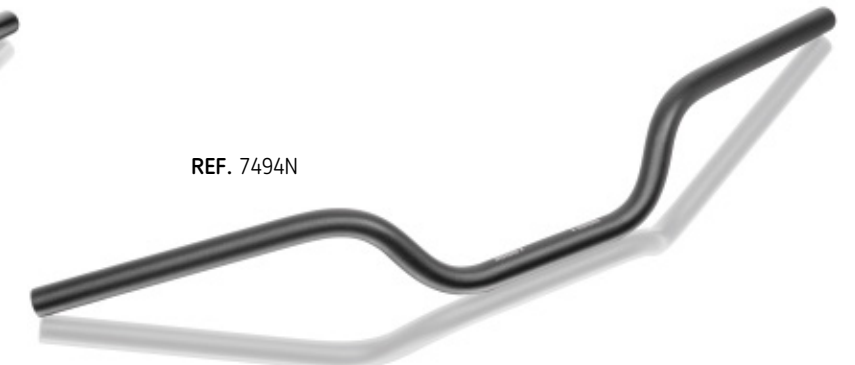
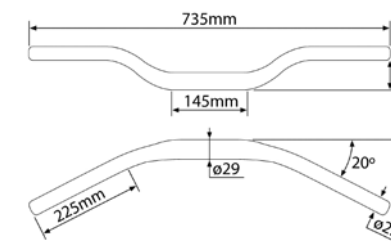

REF. 7494N

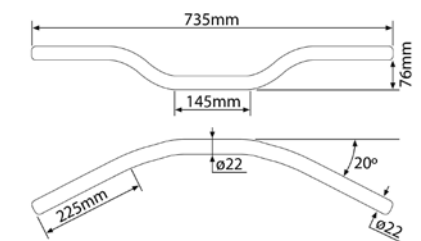

// CONICAL HANDLEBAR

Ø mm.	H (mm.)	REF.	R	O	A	N	P
22/29	20	7492	(*)				
22/29	40	7493	(*)				
22/29	61	6461	(*)				

// CYLINDRIC HANDLEBAR

Ø mm.	H (mm.)	REF.	R	O	A	N	P
22	76	6242	(*)				
22	46	7494	(*)				

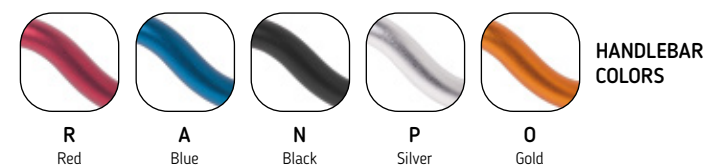

HANDLEBARS SUITABLE FOR OUR BAR ENDS SEE WEBSITE.
 PUIG HANDLEBARS INCORPORATE INTERIOR THREAD.
 (*) Check price with your distributor.
IMPORTANT: Indicate code color after part#. Example: 0973A



RISERS

HI-TECH PARTS | TECHNICAL SECTION

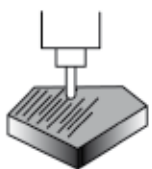

CNC MACHINED
Machined from billet aluminium and anodized in different colors.

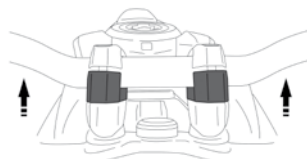

FUNCTIONAL
Allows the handlebars to be raised.

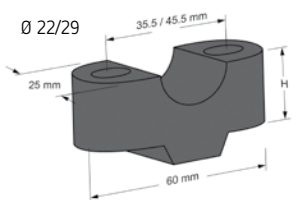

DIMENSIONS

H (mm.)	Ø mm.	REF.	(P) (N)
20	22	3671	(*)
20	29	3740	(*)
20	32	20308	(*)
30	22	3672	(*)
30	29	3741	(*)
30	32	20309	(*)

REF. 3672-3741
Ø 22/29



REF. 3671-3740
Ø 22/29



(*) Check price with your distributor.
IMPORTANT: Indicate code color after part#. Example 0973A



N Black
P Aluminium



HANDLEBAR REINFORCEMENT

HI-TECH PARTS | TECHNICAL SECTION

MODEL	YEAR	REF.	(R) (A) (N) (P)
YAMAHA			
MT-07 TRACER	16' - 18'	9256	(*)

ALUMINIUM BASE



N Black
P Aluminium
R Red
A Blue

REF. 9256N



(*) Check price with your distributor.
IMPORTANT: Indicate code color after part#. Example 0973A

LEVERS 3.0

HI-TECH PARTS | TECHNICAL SECTION



REF. 210AA



REF. 220NA



REF. 230NA



REF. 24ANA



FOLDABLE MODEL 3.0	REF.	R N	O P	A V	T V
FOLDABLE BRAKE LEVER	SEE PAGE 168	(*)			
ADAPTOR BRAKE LEVER	SEE PAGE 170				
FOLDABLE CLUTCH LEVER	SEE PAGE 168	(*)			
ADAPTOR CLUTCH LEVER	SEE PAGE 170				
SELECTOR (SPARES)	3699	(*)			
SCREW-NUT-SPACER-WASHER SPRING (SPARES)	9837	(*)			
DOCK	3512	(*)			

NON-FOLDABLE MODEL 3.0	REF.	R N	O P	A V	T V
NON-FOLDABLE BRAKE LEVER	SEE PAGE 168	(*)			
ADAPTOR BRAKE LEVER	SEE PAGE 170				
FOLDABLE CLUTCH LEVER	SEE PAGE 168	(*)			
ADAPTOR CLUTCH LEVER	SEE PAGE 170				
SELECTOR (SPARES)	3699	(*)			
SCREW-NUT-SPACER-WASHER SPRING (SPARES)	9837	(*)			
DOCK	3512	(*)			

SHORT MODEL 3.0	REF.	R N	O P	A V	T V
SHORT BRAKE HANDLE	SEE PAGE 168	(*)			
ADAPTOR BRAKE LEVER	SEE PAGE 170				
SHORT CLUTCH LEVER	SEE PAGE 168	(*)			
ADAPTOR CLUTCH LEVER	SEE PAGE 170				
SELECTOR (SPARES)	3699	(*)			
SCREW-NUT-SPACER-WASHER SPRING (SPARES)	9837	(*)			
DOCK	3512	(*)			

EXTENDABLE FOLDING MODEL 3.0	REF.	R N	O P	A V	T V
EXTENDABLE FOLDABLE BRAKE LEVER	SEE PAGE 168	(*)			
ADAPTOR BRAKE LEVER	SEE PAGE 170				
EXTENSIBLE FOLDING CLUTCH HANDLE	SEE PAGE 168	(*)			
HANDLE CLUTCH HANDLE	SEE PAGE 170				
SELECTOR (SPARES)	3699	(*)			
EXTENDABLE KIT	3700	(*)			
SCREW-NUT-SPACER-WASHER SPRING (SPARES)	9837	(*)			
SCREW + WASHER EXTENDABLE FASTENING	20503	(*)			
DOCK	3512	(*)			

(*) Check price with your distributor.

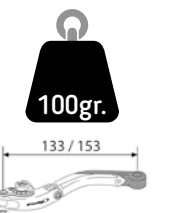
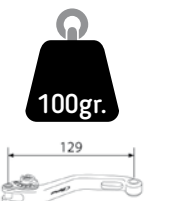

LEVERS 3.0

HI-TECH PARTS

// 5 STEPS TO FIND THE PART# FOR YOUR LEVERS 3.0

1 SELECT TYPE OF LEVER

2 SELECT MODEL OF LEVER 3.0

3 SELECT COLOR OF EXTENDABLE

4 SELECT COLOR OF LEVER

5 SELECT COLOR OF SELECTOR

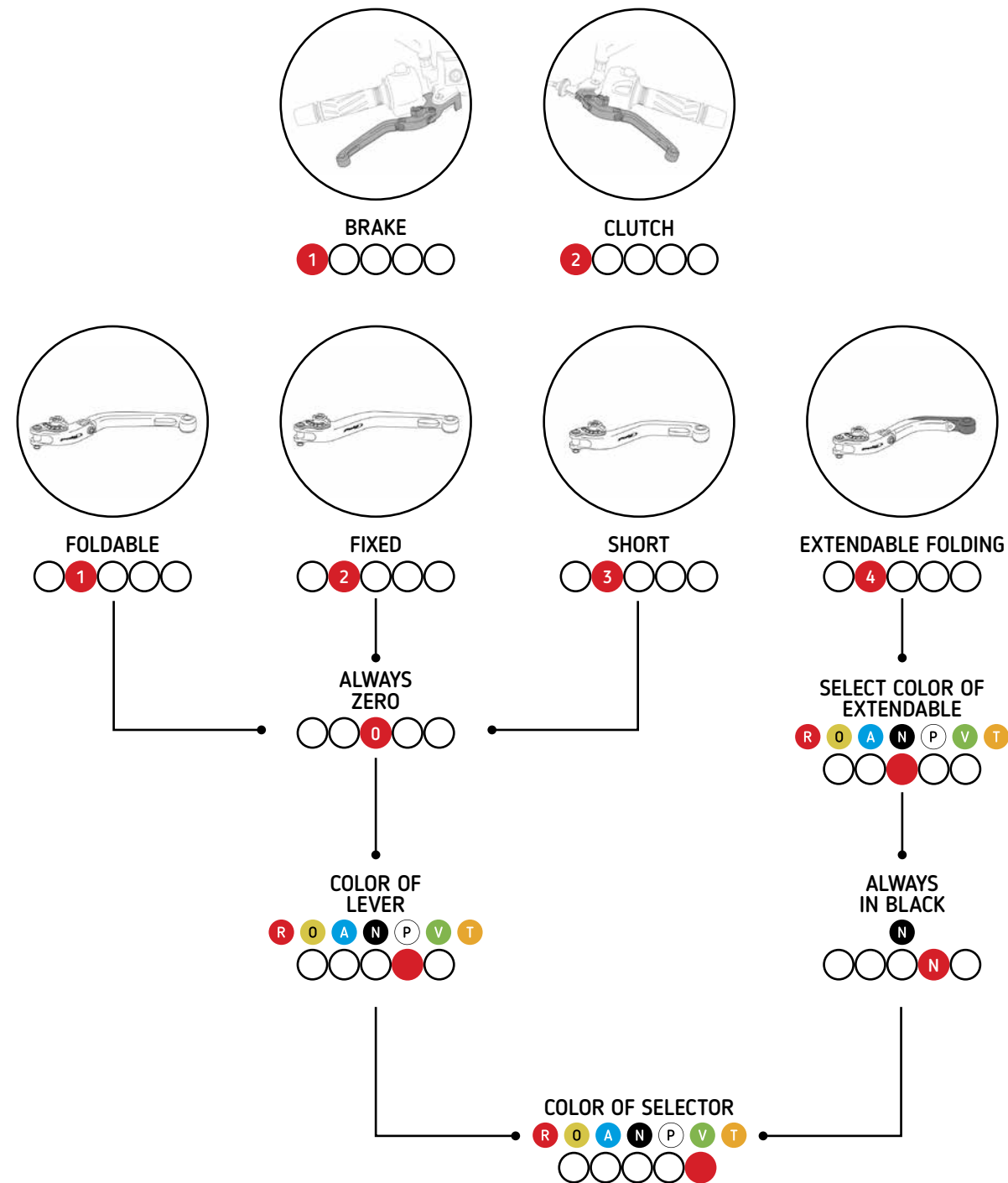

// EXAMPLES ON HOW TO OBTAIN THE PART# FOR THE 3.0 LEVERS



REF. 240NO

- 2 CLUTCH
- 4 EXTENDABLE FOLDING
- 0 COLOR OF EXTENDABLE
- N ALWAYS IN BLACK
- 0 COLOR OF SELECTOR



REF. 120AN

- 1 BRAKE
- 2 FIJA
- 0 ALWAYS ZERO
- A COLOR OF LEVER
- N COLOR OF SELECTOR



REF. 210NT

- 2 CLUTCH
- 1 EXTENDABLE
- 0 ALWAYS ZERO
- N COLOR OF LEVER
- T COLOR OF SELECTOR



REF. 230NA

- 2 BRAKE
- 3 SHORT
- 0 ALWAYS ZERO
- N COLOR OF LEVER
- A COLOR OF SELECTOR

LEVERS ADAPTERS

HI-TECH PARTS

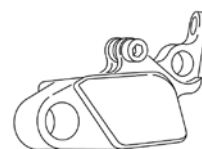

2021 MODELS: www.puig.tv

MODEL	YEAR	ADAPTOR CLUTCH LEVER	N	ADAPTOR BRAKE LEVER	N
APRILIA					
DORSODURO 900	17' - 20'	6140N	(*)	6144N	(*)
RSV4	09' - 12'	8503N	(*)	6141N	(*)
RSV4 FACTORY	13' - 14'	8503N	(*)	6141N	(*)
RSV4 RF	15' - 20'	8503N	(*)	6141N	(*)
RSV4 RR	15' - 20'	8503N	(*)	6141N	(*)
SHIVER 750	07' - 16'	6140N	(*)	6144N	(*)
SHIVER 900	17' - 20'	6140N	(*)	6144N	(*)
TUONO V4R	11' - 14'	8503N	(*)	6578N	(*)
TUONO V4 1100 RR	15' - 16'	8503N	(*)	6578N	(*)
TUONO V4 1100 RR	17' - 20'	8503N	(*)	6141N	(*)
TUONO V4 1100 FACTORY	15' - 16'	8503N	(*)	6578N	(*)
TUONO V4 1100 FACTORY	17' - 20'	8503N	(*)	6141N	(*)
BENELLI					
LEONCINO 250	20'	9695N	(*)	9694N	(*)
LEONCINO 500	16' - 20'	9695N	(*)	9694N	(*)
TRK 502	16' - 20'	9695N	(*)	9694N	(*)
TRK 502 X	16' - 20'	9695N	(*)	9694N	(*)
BMW					
C600 SPORT	12' - 15'	6358N (rear brake)	(*)	6356N (front brake)	(*)
C650 SPORT	16' - 20'	6358N (rear brake)	(*)	6356N (front brake)	(*)
C650 GT	12' - 15'	6358N (rear brake)	(*)	6356N (front brake)	(*)
C650 GT	16' - 20'	6358N (rear brake)	(*)	6356N (front brake)	(*)
F650 GS	08' - 12'	6585N	(*)	6142N	(*)
F700 GS	12' - 17'	6585N	(*)	6142N	(*)
F750 GS	18' - 20'	9783N	(*)	7839N	(*)
F800 GT	13' - 20'	6585N	(*)	6142N	(*)
F800 GS	08' - 17'	6585N	(*)	6142N	(*)
F800 GS ADVENTURE	13' - 17'	6585N	(*)	6142N	(*)
F800R	09' - 20'	6585N	(*)	6142N	(*)
F850 GS	18' - 20'	9783N	(*)	7839N	(*)
F850 GS ADVENTURE	19' - 20'	9783N	(*)	7839N	(*)
F900R	20'	9783N	(*)	7839N	(*)
F900XR	20'	9783N	(*)	7839N	(*)
G310 GS	17' - 20'	8609N	(*)	6143N	(*)
G310 R	16' - 20'	8609N	(*)	6143N	(*)
G650 GS	11' - 16'	6139N	(*)	6143N	(*)
R1200 R	06' - 14'	6137N	(*)	6142N	(*)
R1200 R	15' - 18'	6581N	(*)	6582N	(*)
R1200 RS	15' - 18'	6581N	(*)	6582N	(*)
R1200 GS	04' - 07'	6330N	(*)	6142N	(*)

2021 MODELS: www.puig.tv

MODEL	YEAR	ADAPTOR CLUTCH LEVER	N	ADAPTOR BRAKE LEVER	N
R1200 GS	08' - 12'	6137N	(*)	6142N	(*)
R1200 GS	13' - 18'	6581N	(*)	6582N	(*)
R1200GS EXCLUSIVE	17' - 18'	6581N	(*)	6582N	(*)
R1200GS RALLYE	17' - 18'	6581N	(*)	6582N	(*)
R1200 GS ADVENTURE	07' - 13'	6137N	(*)	6142N	(*)
R1250 GS	18' - 20'	6581N	(*)	6582N	(*)
R1250 GS HP	18' - 20'	6581N	(*)	6582N	(*)
R1250GS ADVENTURE	18' - 20'	6581N	(*)	6582N	(*)
R1250 R	18' - 20'	6581N	(*)	3628N	(*)
R1250 RS	19' - 20'	6581N	(*)	3628N	(*)
R NINE T	14'	6581N	(*)	6582N	(*)
R NINE T (#)	15' - 16'	6581N	(*)	6582N	(*)
R NINE T (&)	15' - 16'	8618N	(*)	7839N	(*)
R NINE T	17' - 20'	8618N	(*)	7839N	(*)
R NINE T SCRAMBLER	16' - 20'	8618N	(*)	7839N	(*)
R NINE T PURE	17' - 20'	8618N	(*)	7839N	(*)
R NINE T RACER	17' - 20'	8618N	(*)	7839N	(*)
R NINE T URBAN G/S	17' - 20'	8618N	(*)	7839N	(*)
S1000 R	14' - 20'	7171N	(*)	5458N	(*)
S1000 RR	09' - 14'	5750N	(*)	5458N	(*)
S1000 RR	15' - 18'	7171N	(*)	5458N	(*)
S1000 RR	19' - 20'	9783N	(*)	5458N	(*)
S1000 XR	15' - 19'	7808N	(*)	7839N	(*)
S1000 XR	20'	9783N	(*)	7839N	(*)
DUCATI					
749S	03' - 06'	6138N	(*)	6141N	(*)
749R	03' - 06'	6138N	(*)	6141N	(*)
848	08' - 10'	6138N	(*)	6141N	(*)
899 PANIGALE	14' - 15'	6138N	(*)	6141N	(*)
959 PANIGALE	16' - 19'	6138N	(*)	6141N	(*)
959 PANIGALE CORSE	18' - 19'	6138N	(*)	6141N	(*)
999S	05' - 06'	6138N	(*)	6141N	(*)
999R	05' - 06'	6138N	(*)	6141N	(*)
1098	07' - 08'	6138N	(*)	6141N	(*)
1198	09' - 11'	6138N	(*)	6141N	(*)
1198S	09' - 11'	6138N	(*)	6141N	(*)
1199 PANIGALE	12' - 14'	6138N	(*)	6141N	(*)
1199 SUPERLEGGERA	14'	6138N	(*)	6141N	(*)
1299 PANIGALE/S	15' - 17'	6138N	(*)	6141N	(*)
DIAVEL	11' - 18'	6138N	(*)	6141N	(*)
DIAVEL 1260/S	19' - 20'	6138N	(*)	6141N	(*)

N
Black

(*) Check price with your distributor.
 (#) With production code WB10J01 from now on.
 (#) BMW R NINE T with production code 0A6, 0A16
 (S) BMW R NINE T with production code 0J01, 0J03
IMPORTANT: Indicate code color after part#. Example 0973A

LEVERS ADAPTERS

HI-TECH PARTS

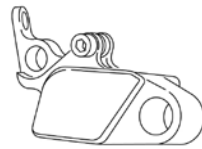
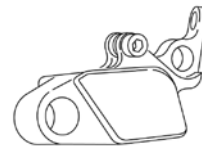

2021 MODELS: www.puig.tv

MODEL	YEAR	ADAPTOR CLUTCH LEVER	N	ADAPTOR BRAKE LEVER	N
HYPERMOTARD 821	13' - 15'	6590N	(*)	5444N	(*)
HYPERMOTARD 821 SP	13' - 15'	6590N	(*)	7980N	(*)
HYPERMOTARD 939	16' - 18'	6590N	(*)	5444N	(*)
HYPERMOTARD 939 SP	16' - 18'	6590N	(*)	5444N	(*)
HYPERMOTARD 950/SP	19' - 20'	6138N	(*)	6141N	(*)
HYPERSTRADA	13' - 15'	6590N	(*)	5444N	(*)
HYPERSTRADA 939	16' - 17'	6590N	(*)	5444N	(*)
MONSTER 696	08' - 14'	5443N	(*)	5444N	(*)
MONSTER 796	10' - 14'	5443N	(*)	5444N	(*)
MONSTER 797	17' - 20'	6590N	(*)	5444N	(*)
MONSTER 821	14' - 20'	6590N	(*)	5444N	(*)
MONSTER 1100	09' - 10'	6138N	(*)	6141N	(*)
MONSTER 1100 EVO	11' - 13'	6138N	(*)	6141N	(*)
MONSTER 1200/S	14' - 16'	6138N	(*)	6141N	(*)
MONSTER 1200/S	17' - 20'	6138N	(*)	6141N	(*)
MONSTER 1200 R	16' - 20'	6138N	(*)	6141N	(*)
MULTISTRADA 950	17' - 18'	6590N	(*)	5444N	(*)
MULTISTRADA 950	19' - 20'	6138N	(*)	6141N	(*)
MULTISTRADA 1200/S	10' - 17'	6138N	(*)	6141N	(*)
MULTISTRADA 1200 PIKES PEAK	16' - 17'	6138N	(*)	6141N	(*)
MULTISTRADA 1200 ENDURO	16' - 19'	6138N	(*)	6141N	(*)
MULTISTRADA 1260/S/S DJAIR	18' - 20'	6138N	(*)	6141N	(*)
MULTISTRADA 1260 PIKES PEAK	18' - 20'	6138N	(*)	6141N	(*)
PANIGALE V2	20'	6138N	(*)	6141N	(*)
SCRAMBLER 1100	18' - 20'	5443N	(*)	5444N	(*)
SCRAMBLER 1100 SPORT	18' - 20'	5443N	(*)	5444N	(*)
SCRAMBLER 1100 SPECIAL	18' - 20'	5443N	(*)	5444N	(*)
SCRAMBLER CAFE RACER	17' - 18'	6590N	(*)	7980N	(*)
SCRAMBLER CAFE RACER	19' - 20'	6138N	(*)	7980N	(*)
SCRAMBLER DESERT SLED	17' - 18'	6590N	(*)	5444N	(*)
SCRAMBLER DESERT SLED	19' - 20'	3876N	(*)	5444N	(*)
SCRAMBLER FLAT TRACK PRO	16'	6590N	(*)	5444N	(*)
SCRAMBLER ICON/CLASSIC/FULL THROTTLE	15' - 18'	6590N	(*)	5444N	(*)
SCRAMBLER ICON/CLASSIC/FULL THROTTLE	19' - 20'	3876N	(*)	5444N	(*)
SCRAMBLER SIXTY2	16' - 18'	6590N	(*)	5444N	(*)
SCRAMBLER SIXTY2	19' - 20'	3876N	(*)	5444N	(*)
SCRAMBLER URBAN ENDURO	15' - 16'	6590N	(*)	5444N	(*)
STREETFIGHTER 848	12' - 15'	6138N	(*)	6141N	(*)
STREETFIGHTER 1100	09' - 12'	6138N	(*)	6141N	(*)
STREETFIGHTER 1100 S	09' - 13'	6138N	(*)	6141N	(*)
STREETFIGHTER V4/S	20'	6138N	(*)	6141N	(*)

2021 MODELS: www.puig.tv

MODEL	YEAR	ADAPTOR CLUTCH LEVER	N	ADAPTOR BRAKE LEVER	N
SUPERSPORT 939/S	17' - 20'	6590N	(*)	6141N	(*)
X DIAVEL/S	16' - 20'	6138N	(*)	6141N	(*)
HONDA					
CB125R NEO SPORTS CAFE	18' - 20'	6115N	(*)	6604N	(*)
CB300R NEO SPORTS CAFE	18' - 20'	6115N	(*)	6604N	(*)
CB500F	13' - 20'	6115N	(*)	6604N	(*)
CB500X	13' - 20'	6115N	(*)	6604N	(*)
CB600F HORNET	98' - 06'	5450N	(*)	5446N	(*)
CB600F HORNET	07' - 15'	5929N	(*)	5446N	(*)
CB650F	14' - 16'	9744N	(*)	5446N	(*)
CB650F	17' - 20'	9744N	(*)	5446N	(*)
CB650R NEO SPORTS CAFE	19' - 20'	9744N	(*)	5446N	(*)
CB900F HORNET	02' - 05'	5450N	(*)	5446N	(*)
CB1000R	08' - 16'	5449N	(*)	5448N	(*)
CB1000R NEO SPORTS CAFE	18' - 20'	9505N	(*)	5448N	(*)
CB1100	13' - 14'	5449N	(*)	5446N	(*)
CB1100RS	17' - 20'	5449N	(*)	5446N	(*)
CB1100EX	17' - 20'	5449N	(*)	5446N	(*)
CB1300	03' - 10'	5449N	(*)	5446N	(*)
CB1300 ABS	03' - 10'	5449N	(*)	5446N	(*)
CBF600/S	04' - 07'	5450N	(*)	5446N	(*)
CBF600/S	08' - 14'	5929N	(*)	5446N	(*)
CBR250R	11' - 15'	6115N	(*)	6604N	(*)
CBR500R	13' - 20'	6115N	(*)	6604N	(*)
CBR650R	19' - 20'	9744N	(*)	5446N	(*)
CBR600F	86' - 07'	5450N	(*)	5446N	(*)
CBR600F	11' - 13'	5929N	(*)	5446N	(*)
CBR600RR	03' - 06'	5445N	(*)	5447N	(*)
CBR600RR	07' - 16'	5445N	(*)	5448N	(*)
CBR650F	14' - 16'	9744N	(*)	5446N	(*)
CBR650F	17' - 19'	9744N	(*)	5446N	(*)
CBR900RR FIRE BLADE	96' - 99'	5450N	(*)	5446N	(*)
CBR900RR FIRE BLADE	00' - 01'	5450N	(*)	5447N	(*)
CBR900RR FIRE BLADE	02' - 03'	5445N	(*)	5447N	(*)
CBR1000RR FIREBLADE	04' - 07'	5449N	(*)	5448N	(*)
CBR1000RR FIREBLADE	08' - 11'	5445N	(*)	5448N	(*)
CBR1000RR FIREBLADE	12' - 13'	5445N	(*)	5448N	(*)
CBR1000RR FIREBLADE/SP	14' - 16'	5445N	(*)	5448N	(*)
CBR1000RR FIREBLADE/SP/SP2	17' - 19'	9505N	(*)	5448N	(*)
CBR1000RR FIREBLADE/SP	20'	9505N	(*)	5448N	(*)
CRF1000L AFRICA TWIN	16' - 19'	8657N	(*)	5446N	(*)

N
Black

(*) Check price with your distributor.
 (#) With production code WB10J01 from now on.
 (B) BMW R NINE T with production code 0A6, 0A16
 (S) BMW R NINE T with production code 0J01, 0J03
IMPORTANT: Indicate code color after part#. Example 0973A

LEVERS ADAPTERS

HI-TECH PARTS



2021 MODELS: www.puig.tv

MODEL	YEAR	ADAPTOR CLUTCH LEVER	N	ADAPTOR BRAKE LEVER	N
CRF1100L AFRICA TWIN	20'	3868N	(*)	3867N	(*)
CRF1100L AFRICA TWIN ADVENTURE SPORTS	20'	3868N	(*)	3867N	(*)
CROSSRUNNER	11' - 14'	5449N	(*)	5446N	(*)
CROSSRUNNER	15' - 20'	5449N	(*)	5446N	(*)
CROSSTOURER	12' - 20'	5449N	(*)	5446N	(*)
INTEGRA 700	12' - 13'	6118N (rear brake)	(*)	5446N (front brake)	(*)
INTEGRA 750	14' - 15'	6118N (rear brake)	(*)	5446N (front brake)	(*)
INTEGRA 750	16' - 20'	6118N (rear brake)	(*)	5446N (front brake)	(*)
INTEGRA 750S	14' - 16'	6118N (rear brake)	(*)	5446N (front brake)	(*)
MSX125	14' - 20'	6115N	(*)	6604N	(*)
NC700S/X	12' - 13'	6115N	(*)	5446N	(*)
NC750S/X	14' - 15'	6115N	(*)	5446N	(*)
NC750S/X	16' - 20'	9744N	(*)	5446N	(*)
NT700V DEAUVILLE	06' - 12'	5450N	(*)	5446N	(*)
VFR800	02' - 13'	5449N	(*)	5446N	(*)
VFR800F	14' - 20'	5449N	(*)	5446N	(*)
VTR1000 SP-1	00' - 02'	5449N	(*)	5447N	(*)
VTR1000 SP-2	02' - 05'	5449N	(*)	5447N	(*)
VFR1200F	10' - 16'	5449N	(*)	6879N	(*)
X-ADV	17' - 20'	6118N (rear brake)	(*)	5446N (front brake)	(*)
INDIAN					
FTR 1200	19' - 20'	20464N	(*)	6141N	(*)
FTR 12000 S	19' - 20'	20464N	(*)	6141N	(*)
KAWASAKI					
ER-5 TWISTER	04' - 05'	5454N	(*)	5455N	(*)
ER-6F	06' - 08'	5454N	(*)	5455N	(*)
ER-6F	09' - 16'	5454N	(*)	5831N	(*)
ER-6N	06' - 08'	5454N	(*)	5455N	(*)
ER-6N	09' - 16'	5454N	(*)	5831N	(*)
GPZ500S	90' - 95'	5454N	(*)	5455N	(*)
J125	15' - 18'	9396N (rear brake)	(*)	9395N (front brake)	(*)
J300	13' - 16'	9396N (rear brake)	(*)	9395N (front brake)	(*)
KLE500	91' - 97'	5454N	(*)	5455N	(*)
NINJA H2	15' - 20'	6138N	(*)	6141N	(*)
NINJA 125	19' - 20'	5753N	(*)	5754N	(*)
NINJA 250R	08' - 12'	5753N	(*)	5754N	(*)
NINJA 250SL	15' - 16'	5753N	(*)	5754N	(*)
NINJA 300	13' - 17'	5753N	(*)	5754N	(*)
NINJA 400	18' - 20'	5753N	(*)	5754N	(*)
NINJA 650	17' - 20'	5454N	(*)	6609N	(*)
NINJA 1000 SX	20'	3496N	(*)	3497N	(*)

2021 MODELS: www.puig.tv

MODEL	YEAR	ADAPTOR CLUTCH LEVER	N	ADAPTOR BRAKE LEVER	N
VERSYS-X 300	17' - 20'	5753N	(*)	5754N	(*)
VERSYS 650	06' - 08'	5454N	(*)	5455N	(*)
VERSYS 650	09' - 14'	5454N	(*)	5831N	(*)
VERSYS 650	15' - 20'	5454N	(*)	6609N	(*)
VERSYS 1000	12' - 14'	5451N	(*)	5455N	(*)
VERSYS 1000	15' - 18'	5454N	(*)	6609N	(*)
VERSYS 1000	19' - 20'	3496N	(*)	3497N	(*)
VERSYS 1000 SE	19' - 20'	3496N	(*)	3497N	(*)
VULCAN S	15' - 20'	5454N	(*)	6609N	(*)
VULCAN S CAFE	17' - 20'	5454N	(*)	6609N	(*)
Z125	17' - 20'	5753N	(*)	5754N	(*)
Z250SL	15' - 16'	5753N	(*)	5754N	(*)
Z300	15' - 17'	5753N	(*)	5754N	(*)
Z400	19' - 20'	5753N	(*)	5754N	(*)
Z650	17' - 20'	5454N	(*)	6609N	(*)
Z750	04' - 06'	5454N	(*)	5455N	(*)
Z750	07' - 12'	5451N	(*)	5453N	(*)
Z750R	11' - 12'	5451N	(*)	5452N	(*)
Z800	13' - 16'	5451N	(*)	6609N	(*)
Z800E	13' - 16'	5451N	(*)	6609N	(*)
Z900	17' - 20'	5454N	(*)	6609N	(*)
Z900RS	18' - 20'	5454N	(*)	5452N	(*)
Z900RS CAFÉ	18' - 20'	5454N	(*)	5452N	(*)
Z1000	03' - 06'	5451N	(*)	5455N	(*)
Z1000	07' - 13'	5451N	(*)	5452N	(*)
Z1000	14' - 16'	5451N	(*)	5452N	(*)
Z1000/R	17' - 20'	5454N	(*)	5452N	(*)
Z1000SX	11' - 16'	5451N	(*)	5452N	(*)
Z1000SX	17' - 20'	5454N	(*)	5452N	(*)
ZEPHYR 750	91' - 99'	5454N	(*)	5455N	(*)
ZR7	99' - 03'	5454N	(*)	5455N	(*)
ZR7S	01' - 03'	5454N	(*)	5455N	(*)
ZX-6R	94' - 99'	5454N	(*)	5455N	(*)
ZX-6R	00' - 04'	5451N	(*)	5455N	(*)
ZX-6R	05' - 06'	5451N	(*)	5458N	(*)
ZX-6R	07' - 16'	5451N	(*)	5452N	(*)
ZX-6R	18' - 20'	5454N	(*)	5452N	(*)
ZX-6R 636	13' - 16'	5451N	(*)	5452N	(*)
ZX-9R	98' - 99'	5454N	(*)	5455N	(*)
ZX-9R	00' - 04'	5451N	(*)	5455N	(*)
ZX-10R	04' - 05'	5451N	(*)	5455N	(*)

N
Black

(*) Check price with your distributor.
 (#) With production code WB10J01 from now on.
 (B) BMW R NINE T with production code 0A6, 0A16
 (S) BMW R NINE T with production code 0J01, 0J03
IMPORTANT: Indicate code color after part#. Example 0973A

LEVERS ADAPTERS

HI-TECH PARTS

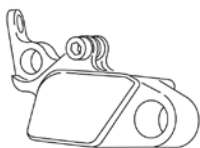

2021 MODELS: www.puig.tv

MODEL	YEAR	ADAPTOR CLUTCH LEVER	N	ADAPTOR BRAKE LEVER	N
ZX-10R	06' - 10'	5451N	(*)	5452N	(*)
ZX-10R	11' - 15'	5451N	(*)	5452N	(*)
ZX-10R	16' - 20'	5451N	(*)	6141N	(*)
ZX-10RR	17' - 20'	5451N	(*)	6141N	(*)
ZX-10R SE	18' - 20'	5451N	(*)	6141N	(*)
ZX-12R	00' - 06'	5451N	(*)	5455N	(*)
ZZR600	93' - 06'	5454N	(*)	5455N	(*)
ZZR1400	12' - 20'	6126N	(*)	5452N	(*)
KTM					
125 DUKE	14' - 16'	7727N	(*)	7728N	(*)
125 DUKE	17' - 20'	7727N	(*)	9511N	(*)
200 DUKE	12' - 15'	7727N	(*)	7728N	(*)
390 DUKE	13' - 16'	7727N	(*)	7728N	(*)
390 DUKE	17' - 20'	7727N	(*)	9511N	(*)
690 DUKE	14' - 20'	9185N	(*)	5444N	(*)
690 DUKE R	14 - 17'	9185N	(*)	6141N	(*)
790 DUKE	18' - 20'	9686N	(*)	9688N	(*)
1290 SUPERDUKE R	14' - 20'	3639N	(*)	6141N	(*)
1290 SUPERDUKE GT	16' - 19'	3639N	(*)	6141N	(*)
KYMCO					
AK550	17' - 20'	9811N (rear brake)	(*)	9811N (front brake)	(*)
DOWNTOWN 125i	09' - 14'	9396N (rear brake)	(*)	9395N (front brake)	(*)
DOWNTOWN 300i	09' - 14'	9396N (rear brake)	(*)	9395N (front brake)	(*)
G-DINK 50	12' - 18'	9396N (rear brake)	(*)	9395N (front brake)	(*)
G-DINK 125i	12' - 18'	9396N (rear brake)	(*)	9395N (front brake)	(*)
G-DINK 300i	12' - 18'	9396N (rear brake)	(*)	9395N (front brake)	(*)
K-XCT 125i	13' - 16'	9396N (rear brake)	(*)	9395N (front brake)	(*)
K-XCT 300i	13' - 16'	9396N (rear brake)	(*)	9395N (front brake)	(*)
NEW DOWNTOWN 125i	15' - 20'	9396N (rear brake)	(*)	9395N (front brake)	(*)
NEW DOWNTOWN 350i	15' - 20'	9396N (rear brake)	(*)	9395N (front brake)	(*)
SUPERDINK 125i	09' - 20'	9396N (rear brake)	(*)	9395N (front brake)	(*)
SUPERDINK 350i	09' - 20'	9396N (rear brake)	(*)	9395N (front brake)	(*)
XCITING 400i	14' - 20'	9396N (rear brake)	(*)	9395N (front brake)	(*)
YAGER GT 125i	13' - 18'	9396N (rear brake)	(*)	9395N (front brake)	(*)
YAGER GT 300i	13' - 18'	9396N (rear brake)	(*)	9395N (front brake)	(*)
SUZUKI					
B-KING	08' - 11'	5880N	(*)	5458N	(*)
BURGMAN 400	17' - 20'	9558N	(*)	9915N	(*)
DL250 V-STROM	17' - 20'	5765N	(*)	5455N	(*)
DL650 V-STROM	04' - 10'	6254N	(*)	5455N	(*)
DL650 V-STROM	11'	5927N	(*)	5455N	(*)

2021 MODELS: www.puig.tv

MODEL	YEAR	ADAPTOR CLUTCH LEVER	N	ADAPTOR BRAKE LEVER	N
DL650 V-STROM	12' - 20'	5926N	(*)	5455N	(*)
DL650XT V-STROM	15' - 20'	5926N	(*)	5455N	(*)
DL1000 V-STROM	02' - 07'	5459N	(*)	5455N	(*)
DL1000 V-STROM	14' - 20'	5459N	(*)	5455N	(*)
DL1000XT V-STROM	17' - 20'	5459N	(*)	5455N	(*)
DL1050 V-STROM	20'	5459N	(*)	5455N	(*)
DL1050XT V-STROM	20'	5459N	(*)	5455N	(*)
GSF650 BANDIT	07' - 11'	5459N	(*)	5455N	(*)
GSF650S BANDIT	07' - 14'	5459N	(*)	5455N	(*)
GSF1200 BANDIT	01' - 06'	5459N	(*)	5455N	(*)
GSF1250 BANDIT	07' - 13'	5459N	(*)	5455N	(*)
GSF1250S BANDIT	07' - 13'	5459N	(*)	5455N	(*)
GSF1250S BANDIT	15' - 16'	5459N	(*)	5455N	(*)
GSR600	06' - 11'	5456N	(*)	5455N	(*)
GSR750	11' - 16'	5456N	(*)	5455N	(*)
GSX650F	08' - 17'	5459N	(*)	5455N	(*)
GSX1250F	10' - 17'	5459N	(*)	5455N	(*)
GSX1400	01' - 06'	5459N	(*)	5455N	(*)
GSX-R125	17' - 20'	9961N	(*)	9962N	(*)
GSX-R250	17' - 20'	5765N	(*)	5455N	(*)
GSX-R600	96' - 03'	5456N	(*)	5455N	(*)
GSX-R600	04' - 05'	5456N	(*)	5458N	(*)
GSX-R600	06' - 10'	5457N	(*)	5458N	(*)
GSX-R600	11' - 16'	5766N	(*)	5458N	(*)
GSX-R750	96' - 03'	5456N	(*)	5455N	(*)
GSX-R750	04' - 05'	5456N	(*)	5458N	(*)
GSX-R750	06' - 10'	5457N	(*)	5458N	(*)
GSX-R750	11' - 16'	5766N	(*)	5458N	(*)
GSX-R1000	01' - 04'	5456N	(*)	5455N	(*)
GSX-R1000	05' - 06'	5457N	(*)	5458N	(*)
GSX-R1000	07' - 08'	5459N	(*)	5458N	(*)
GSX-R1000	09' - 16'	5766N	(*)	5458N	(*)
GSX-R1000/R	17' - 20'	5766N	(*)	5458N	(*)
GSX-R1300 HAYABUSA	99' - 07'	5459N	(*)	5455N	(*)
GSX-S125	17' - 19'	9961N	(*)	9962N	(*)
GSX-S125	20'	20502N	(*)	9962N	(*)
GSX-S750	17' - 20'	5765N	(*)	5455N	(*)
GSX-S1000	15' - 20'	5766N	(*)	5458N	(*)
GSX-S1000F	15' - 20'	5766N	(*)	5458N	(*)
INAZUMA	13' - 17'	5765N	(*)	5455N	(*)
KATANA	19' - 20'	5766N	(*)	5458N	(*)



N

Black

(*) Check price with your distributor.
 (#) With production code WB10J01 from now on.
 (B) BMW R NINE T with production code 0A6, 0A16
 (S) BMW R NINE T with production code 0J01, 0J03
IMPORTANT: Indicate code color after part#. Example 0973A

LEVERS ADAPTERS

HI-TECH PARTS

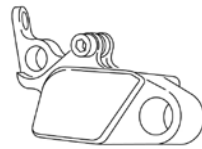
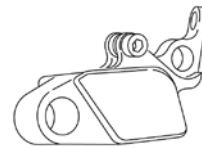

2021 MODELS: www.puig.tv

MODEL	YEAR	ADAPTOR CLUTCH LEVER	N	ADAPTOR BRAKE LEVER	N
SFV650 GLADIUS	09' - 15'	5765N	(*)	5455N	(*)
SV650	99' - 04'	6254N	(*)	5455N	(*)
SV650	05'	6254N	(*)	5455N	(*)
SV650	06' - 08'	6254N	(*)	5455N	(*)
SV650	16' - 20'	5765N	(*)	5455N	(*)
SV650S	99' - 04'	6254N	(*)	5455N	(*)
SV650S	05'	6254N	(*)	5455N	(*)
SV650S	06' - 08'	6254N	(*)	5455N	(*)
SV650X	18'	5765N	(*)	5455N	(*)
SV1000	03' - 07'	5459N	(*)	5455N	(*)
SV1000S	03' - 07'	5459N	(*)	5455N	(*)
TRIUMPH					
BONNEVILLE T100	05' - 16'	5767N	(*)	5455N	(*)
BONNEVILLE T100	17' - 19'	7826N	(*)	5455N	(*)
BONNEVILLE T120	16' - 19'	7826N	(*)	5455N	(*)
DAYTONA 600	03' - 04'	5767N	(*)	5455N	(*)
DAYTONA 650	05'	5767N	(*)	5455N	(*)
DAYTONA 675	06' - 12'	5767N	(*)	5458N	(*)
DAYTONA 675	13' - 17'	5767N	(*)	5458N	(*)
DAYTONA 675 R	13' - 17'	5767N	(*)	6141N	(*)
DAYTONA 955i	04' - 06'	5767N	(*)	5455N	(*)
ROCKET III	04' - 07'	5767N	(*)	5455N	(*)
ROCKET III CLASSIC	07' - 10'	5767N	(*)	5455N	(*)
ROCKET III ROADSTER	10' - 16'	5767N	(*)	5455N	(*)
SCRAMBLER	06' - 13'	5767N	(*)	5455N	(*)
SCRAMBLER 1200XC	19' - 20'	7826N	(*)	6141N	(*)
SPEED FOUR	05' - 06'	5767N	(*)	5455N	(*)
SPEEDMASTER	05' - 17'	5767N	(*)	5455N	(*)
SPEED TRIPLE axial.	05' - 08'	5767N	(*)	5455N	(*)
SPEED TRIPLE radial.	08' - 10'	5767N	(*)	5458N	(*)
SPEED TRIPLE	11' - 15'	5767N	(*)	6141N	(*)
SPEED TRIPLE R	12' - 15'	5767N	(*)	6141N	(*)
SPEED TRIPLE/R	16' - 20'	7826N	(*)	6141N	(*)
SPEED TWIN	19' - 20'	7826N	(*)	6141N	(*)
SPRINT ST 1050	05' - 10'	5767N	(*)	5455N	(*)
STREET CUP	17' - 20'	7826N	(*)	5455N	(*)
STREET SCRAMBLER	17' - 20'	7826N	(*)	5455N	(*)
STREET TRIPLE	08' - 16'	5767N	(*)	5455N	(*)
STREET TRIPLE R	09' - 16'	5767N	(*)	5458N	(*)
STREET TRIPLE/R	17' - 19'	7826N	(*)	6141N	(*)
STREET TRIPLE S	17' - 19'	7826N	(*)	5455N	(*)

2021 MODELS: www.puig.tv

MODEL	YEAR	ADAPTOR CLUTCH LEVER	N	ADAPTOR BRAKE LEVER	N
STREET TWIN	16' - 19'	7826N	(*)	5455N	(*)
THRUXTON	04' - 15'	5767N	(*)	5455N	(*)
THRUXTON 1200	16' - 20'	7826N	(*)	5455N	(*)
THRUXTON 1200 R	16' - 20'	7826N	(*)	6141N	(*)
TIGER 800	11' - 14'	5767N	(*)	5455N	(*)
TIGER 800 XC	11' - 14'	5767N	(*)	5455N	(*)
TIGER 800 XC/XCX/XCA	15' - 20'	7826N	(*)	5455N	(*)
TIGER 800 XR/XRX/XRT	15' - 20'	7826N	(*)	5455N	(*)
TIGER 900	20'	7826N	(*)	20385N	(*)
TIGER 900 GT	20'	7826N	(*)	20385N	(*)
TIGER 900 GT LOW	20'	7826N	(*)	20385N	(*)
TIGER 900 GT PRO	20'	7826N	(*)	20385N	(*)
TIGER 900 RALLY	20'	7826N	(*)	20385N	(*)
TIGER 900 RALLY PRO	20'	7826N	(*)	20385N	(*)
TIGER 1050	07' - 13'	5767N	(*)	5455N	(*)
TIGER SPORT	13' - 16'	5767N	(*)	5455N	(*)
TIGER SPORT	17' - 20'	7826N	(*)	5455N	(*)
TIGER EXPLORER	12' - 15'	6620N	(*)	5455N	(*)
TIGER EXPLORER XC	13' - 15'	6620N	(*)	5455N	(*)
TIGER EXPLORER XC/XR/XRX/XRT/XCX/XCA	16' - 20'	6620N	(*)	5455N	(*)
YAMAHA					
FAZER8	13' - 16'	8503N	(*)	5462N	(*)
FJR1300	01' - 02'	5465N	(*)	5455N	(*)
FJR1300	03' - 05'	5465N	(*)	5462N	(*)
FJR1300A/AS	06' - 12'	5465N	(*)	5462N	(*)
FJR1300A/AS	13' - 19'	5465N	(*)	5462N	(*)
FZ1	06' - 15'	8503N	(*)	5462N	(*)
FZ1 FAZER	06' - 15'	8503N	(*)	5462N	(*)
FZ6	04' - 06'	8503N	(*)	5462N	(*)
FZ6 S2	07' - 10'	8503N	(*)	5462N	(*)
FZ6 FAZER	07' - 08'	8503N	(*)	5462N	(*)
FZ6 FAZER S2	07' - 10'	8503N	(*)	5462N	(*)
FZ8	10' - 16'	8503N	(*)	5462N	(*)
FZ8 FAZER	10' - 12'	8503N	(*)	5462N	(*)
FZS1000 FAZER	01' - 05'	8503N	(*)	5455N	(*)
MT-125	14' - 19'	6120N	(*)	7582N	(*)
MT-125	20'	6120N	(*)	3886N	(*)
MT-01	05' - 13'	5465N	(*)	5464N	(*)
MT-03	16' - 20'	7830N	(*)	7861N	(*)
MT-07	14' - 20'	8503N	(*)	5462N	(*)
MT-07 TRACER	16' - 20'	8503N	(*)	5462N	(*)

N
Black

(*) Check price with your distributor.
 (#) With production code WB10J01 from now on.
 (R) BMW R NINE T with production code 0A6, 0A16
 (S) BMW R NINE T with production code 0J01, 0J03
IMPORTANT: Indicate code color after part#. Example 0973A

LEVERS ADAPTERS

HI-TECH PARTS

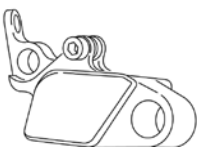
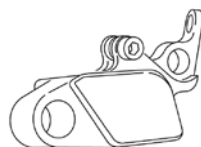
2021 MODELS: www.puig.tv

MODEL	YEAR	ADAPTOR CLUTCH LEVER	N	ADAPTOR BRAKE LEVER	N
MT-07 TRACER GT	19'	8503N	(*)	5462N	(*)
MT-09	13' - 16'	8503N	(*)	5462N	(*)
MT-09	17' - 20'	8503N	(*)	5462N	(*)
MT-09 SP	18' - 20'	8503N	(*)	5462N	(*)
MT-09 TRACER	15' - 17'	8873N	(*)	5462N	(*)
MT-09 TRACER	18' - 20'	8873N	(*)	5462N	(*)
MT-09 TRACER GT	18' - 20'	8873N	(*)	5462N	(*)
MT-10	16' - 20'	8873N	(*)	5462N	(*)
MT-10 SP	17' - 20'	8873N	(*)	5462N	(*)
NIKEN	18' - 20'	8873N	(*)	5462N	(*)
TENERE 700	19' - 20'	8503N	(*)	5462N	(*)
T-MAX 500	08' - 11'	5976N (rear brake)	(*)	5462N (front brake)	(*)
T-MAX 530	12' - 14'	5976N (rear brake)	(*)	5462N (front brake)	(*)
T-MAX 530	15' - 16'	5976N (rear brake)	(*)	5462N (front brake)	(*)
T-MAX 530/DX/SX	17' - 19'	5976N (rear brake)	(*)	5462N (front brake)	(*)
T-MAX 560 /SX/DX/MAX TECH	20'	5976N (rear brake)	(*)	5462N (front brake)	(*)
VMAX Bomba Nisin	09' - 19'	5465N	(*)	5464N	(*)
X-MAX 125	06' - 17'	6332N (rear brake)	(*)	6333N (front brake)	(*)
X-MAX 125	18' - 20'	9493N (rear brake)	(*)	7861N (front brake)	(*)
X-MAX 250	10' - 16'	6332N (rear brake)	(*)	6333N (front brake)	(*)
X-MAX 300	17' - 20'	9493N (rear brake)	(*)	7861N (front brake)	(*)
X-MAX 400	13' - 20'	7000N (rear brake)	(*)	7001N (front brake)	(*)
XJ6	09' - 16'	8503N	(*)	5462N	(*)
XJ6 DIVERSION	09' - 16'	8503N	(*)	5462N	(*)
XJ6 DIVERSION F	10' - 16'	8503N	(*)	5462N	(*)
XJR1200	94' - 98'	5465N	(*)	5455N	(*)
XJR1300	04' - 16'	5465N	(*)	5462N	(*)
XSR700	16' - 20'	8503N	(*)	5462N	(*)
XSR700 XTRIBUTE	19' - 20'	8503N	(*)	5462N	(*)
XSR900	16' - 20'	8503N	(*)	5462N	(*)
XT660R	04' - 16'	5855N	(*)	5854N	(*)
XT660X	04' - 16'	5855N	(*)	5854N	(*)
XT660Z TÉNÉRÉ	08' - 19'	6120N	(*)	5462N	(*)
XT1200Z SUPER TÉNÉRÉ	10' - 20'	5465N	(*)	5462N	(*)
YZF-R125	14' - 20'	6120N	(*)	7582N	(*)
YZF-R1	99' - 01'	8503N	(*)	6609N	(*)
YZF-R1	02' - 03'	8503N	(*)	5455N	(*)
YZF-R1	04' - 08'	8503N	(*)	5464N	(*)
YZF-R1	09' - 14'	8503N	(*)	5768N	(*)
YZF-R1	15' - 20'	8503N	(*)	7860N	(*)
YZF-R1M	17' - 20'	8503N	(*)	7860N	(*)

2021 MODELS: www.puig.tv

MODEL	YEAR	ADAPTOR CLUTCH LEVER	N	ADAPTOR BRAKE LEVER	N
YZF-R3	15' - 20'	7830N	(*)	7861N	(*)
YZF-R6	99' - 05'	8503N	(*)	5455N	(*)
YZF-R6 Bomba Radial	05'	8503N	(*)	5464N	(*)
YZF-R6	06' - 16'	8503N	(*)	5464N	(*)
YZF-R6	17' - 20'	8503N	(*)	7860N	(*)

N
Black

(*) Check price with your distributor.
 (#) With production code WB10J01 from now on.
 (#) BMW R NINE T with production code 0A6, 0A16
 (#) BMW R NINE T with a production code 0J01, 0J03
IMPORTANT: Indicate code color after part#. Example 0973A

THERMAL GLOVES ANTI-VIBRATION

HI-TECH PARTS | TECHNICAL SECTION



MODEL	REF.	N	R	A
THERMAL GLOVES ANTI-VIBRATION BY PAIR C/BLACK	7778N	(*)		
THERMAL GLOVES ANTI-VIBRATION BY PAIR C/RED	7778R	(*)		
THERMAL GLOVES ANTI-VIBRATION BY PAIR C/BLUE	7778A	(*)		

N
BlackR
RedA
Blue

(*) Check price with your distributor.
IMPORTANT: Indicate code color after part#. Example 0973A

BRAKE / CLUTCH LEVER PROTECTOR

HI-TECH PARTS | TECHNICAL SECTION

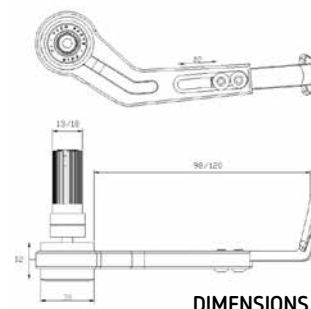
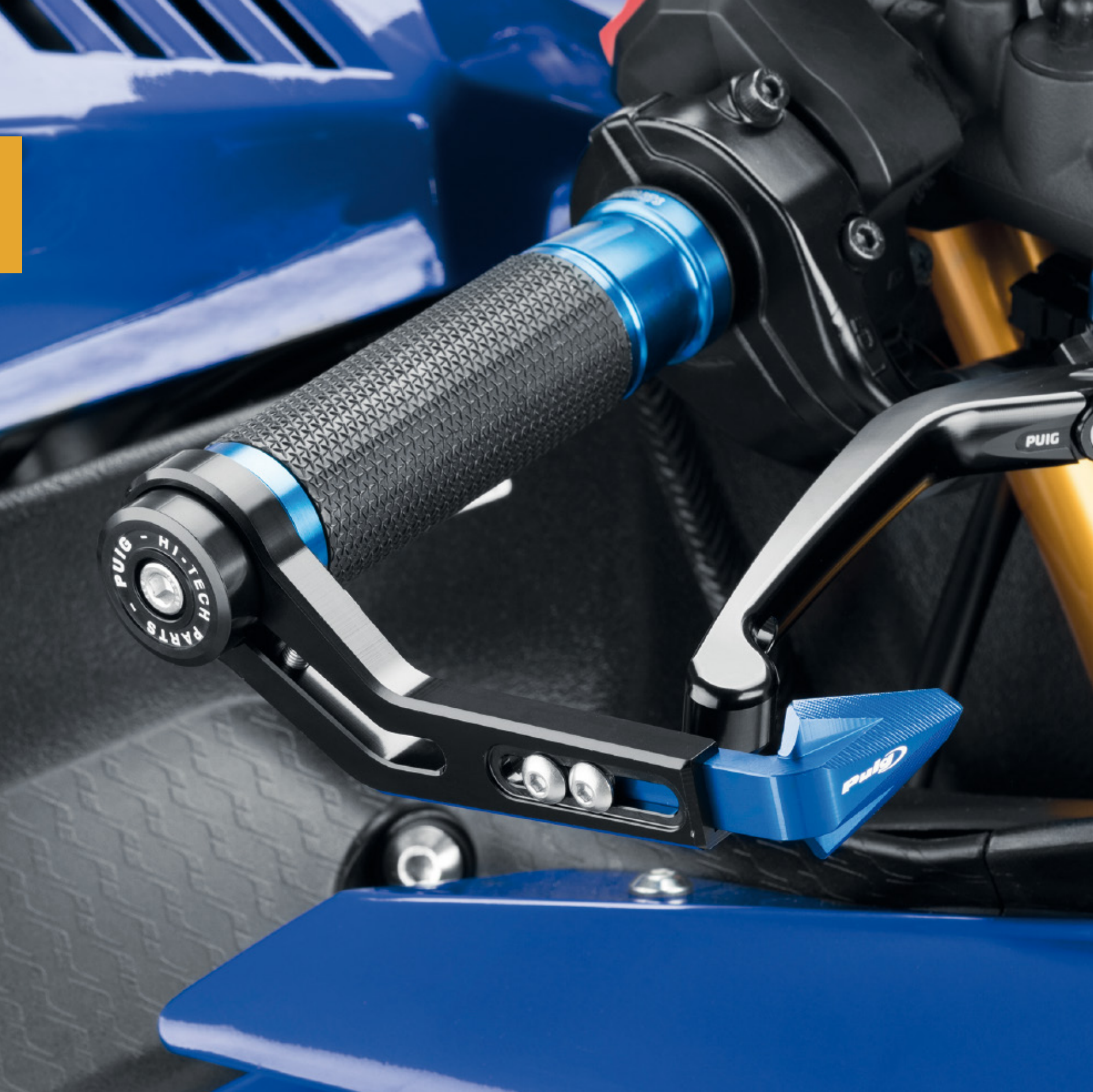

DIMENSIONS

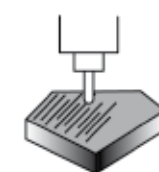

MACHINED
Machined from billet aluminium and anodized in colors.



ADJUSTABLE



ADAPTABLE
Specific available adapters for bike model.

Universal models for handlebars diameters between 13-18 mm.



MODEL	REF.	R O A T N P V
BRAKE LEVER PROTECTOR UNIVERSAL 13-18 mm. DIAMETER	3765	(*)
CLUTCH LEVER PROTECTOR UNIVERSAL 13-18 mm. DIAMETER	3877	(*)

SPARES	REF.	R O A T N P V
END TIP PROTECTOR FOR BRAKE LEVER - SPARE	3766	(*)
END TIP PROTECTOR CLUTCH LEVER - SPARE	3878	(*)

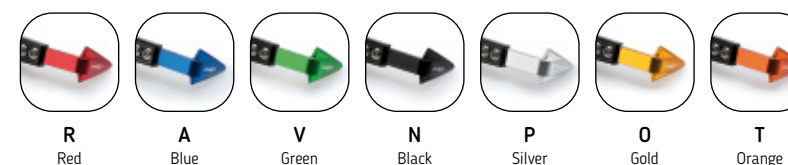

FOR MODELS THAT REQUIRE ADAPTERS SEE PAGE 184.
REFERENCES FOR BARENDS ON THE CLUTCH SIDE TO MATCH THE BAREND USED WITH THE BRAKE LEVER PROTECTOR SEE PAGE 184.

(*) Check price with your distributor.
IMPORTANT: Indicate code color after part#. Example 0973A

BRAKE / CLUTCH LEVER PROTECTOR ADAPTORS

HI-TECH PARTS



2021 MODELS: www.puig.tv

MODEL	YEAR	ADAPTOR REF.	N	LEFT SIDE BAR END REF.	N
APRILIA					
RSV4 RF/RR	15' - 20'	3807N	(*)	3810N	(*)
SHIVER 900	17' - 20'	9871N	(*)	9871N	(*)
TUONO V4 1100 FACTORY	15' - 20'	3159N	(*)	3811N	(*)
BENELLI					
LEONCINO 250	20'	9699N	(*)	9699N	(*)
LEONCINO 500	16' - 20'	9699N	(*)	9699N	(*)
BMW					
C600 SPORT	12' - 15'	9580N	(*)	9580N	(*)
C650 SPORT	16' - 20'	9580N	(*)	9580N	(*)
F800 R	09' - 20'	9587N	(*)	9587N	(*)
F900 R	20'	9990N	(*)	9990N	(*)
G310 R	16' - 20'	9850N	(*)	9850N	(*)
R1200 R	09' - 18'	9990N	(*)	9990N	(*)
R1200 RS	15' - 18'	20352N	(*)	20352N	(*)
R1250 RS	19' - 20'	20352N	(*)	20352N	(*)
R NINE T/SCRAMBLER/PURE/URBAN G/S	20'	9581N	(*)	9581N	(*)
S1000 R	14' - 20'	9581N	(*)	9581N	(*)
S1000RR	15' - 18'	9581N	(*)	9581N	(*)
S1000RR	19' - 20'	3776N	(*)	3776N	(*)
DUCATI					
959 PANIGALE	16' - 19'	20426N	(*)	3770N	(*)
959 PANIGALE CORSE	18' - 19'	20426N	(*)	3770N	(*)
1199 PANIGALE	12' - 14'	UNIVERSAL - IT DOES NOT REQUIRE ADAPTOR		3770N	(*)
1199 PANIGALE R	15' - 17'	UNIVERSAL - IT DOES NOT REQUIRE ADAPTOR		3770N	(*)
1299 PANIGALE/S	15' - 17'	UNIVERSAL - IT DOES NOT REQUIRE ADAPTOR		3770N	(*)
DIAVEL 1260/S	19' - 20'	UNIVERSAL - IT DOES NOT REQUIRE ADAPTOR		3770N	(*)
MONSTER 797	17' - 20'	UNIVERSAL - IT DOES NOT REQUIRE ADAPTOR		3770N	(*)
MONSTER 821	14' - 20'	UNIVERSAL - IT DOES NOT REQUIRE ADAPTOR		3770N	(*)
MONSTER 1200 R	16' - 20'	UNIVERSAL - IT DOES NOT REQUIRE ADAPTOR		3770N	(*)
MONSTER 1200/S	17' - 20'	UNIVERSAL - IT DOES NOT REQUIRE ADAPTOR		3770N	(*)
PANIGALE V2	20'	20426N	(*)	20426N	(*)
PANIGALE 1100 V4/S	18' - 20'	20426N	(*)	20426N	(*)
SCRAMBLER 1100	18' - 20'	UNIVERSAL - IT DOES NOT REQUIRE ADAPTOR		3770N	(*)
SCRAMBLER 1100 SPORT	18' - 20'	UNIVERSAL - IT DOES NOT REQUIRE ADAPTOR		3770N	(*)
SCRAMBLER 1100 SPECIAL	18' - 20'	UNIVERSAL - IT DOES NOT REQUIRE ADAPTOR		3770N	(*)
SCRAMBLER DESERT SLED	17' - 20'	UNIVERSAL - IT DOES NOT REQUIRE ADAPTOR		3770N	(*)
SCRAMBLER FLAT TRACK PRO	16'	UNIVERSAL - IT DOES NOT REQUIRE ADAPTOR		3770N	(*)
SCRAMBLER ICON/CLASSIC/FULL THROTTLE	15' - 20'	UNIVERSAL - IT DOES NOT REQUIRE ADAPTOR		3770N	(*)
SCRAMBLER SIXTY2	16' - 20'	UNIVERSAL - IT DOES NOT REQUIRE ADAPTOR		3770N	(*)

2021 MODELS: www.puig.tv

MODEL	YEAR	ADAPTOR REF.	N	LEFT SIDE BAR END REF.	N
SCRAMBLER URBAN ENDURO	15' - 16'	UNIVERSAL - IT DOES NOT REQUIRE ADAPTOR		3770N	(*)
STREETFIGHTER V4/S	20'	UNIVERSAL - IT DOES NOT REQUIRE ADAPTOR		3770N	(*)
SUPERSPORT 939/S	17' - 20'	UNIVERSAL - IT DOES NOT REQUIRE ADAPTOR		3770N	(*)
X DIAVEL	16' - 20'	UNIVERSAL - IT DOES NOT REQUIRE ADAPTOR		3770N	(*)
HARLEY DAVIDSON					
SPORTSTER 883 IRON (XL883N)	09' - 13'	9662N	(*)	3777N	(*)
SPORTSTER 883 IRON (XL883N)	14' - 16'	9662N	(*)	3777N	(*)
SPORTSTER 883 IRON (XL883N/17)	17' - 20'	9662N	(*)	3777N	(*)
SPORTSTER 883 SUPERLOW (XL883L)	11' - 13'	9662N	(*)	3777N	(*)
SPORTSTER 883 SUPERLOW (XL883L)	14' - 16'	9662N	(*)	3777N	(*)
SPORTSTER 883 SUPERLOW (XL883L/17)	17' - 20'	9662N	(*)	3777N	(*)
SPORTSTER 883R ROADSTER (XL883R/06)	06' - 13'	9662N	(*)	3777N	(*)
SPORTSTER 883R ROADSTER (XL883R/06)	14' - 20'	9662N	(*)	3777N	(*)
SPORTSTER 1200 CUSTOM (XL1200C/11)	11' - 13'	9662N	(*)	3777N	(*)
SPORTSTER 1200 CUSTOM (XL1200C/11)	14' - 16'	9662N	(*)	3777N	(*)
SPORTSTER 1200 CUSTOM (XL1200C/17)	17' - 20'	9662N	(*)	3777N	(*)
SPORTSTER 1200 SUPER LOW (XL1200T)	17' - 20'	9662N	(*)	3777N	(*)
SPORTSTER 1200 SUPER LOW (XL1200T/17)	17' - 20'	9662N	(*)	3777N	(*)
SPORTSTER 1200 ROADSTER (XL1200CX)	16' - 20'	9662N	(*)	3777N	(*)
HONDA					
CB125F	15' - 20'	UNIVERSAL - IT DOES NOT REQUIRE ADAPTOR		3770N	(*)
CB125R NEO SPORTS CAFE	18' - 20'	UNIVERSAL - IT DOES NOT REQUIRE ADAPTOR		3770N	(*)
CB300R NEO SPORTS CAFE	18' - 20'	UNIVERSAL - IT DOES NOT REQUIRE ADAPTOR		3770N	(*)
CB650R NEO SPORTS CAFÉ	19' - 20'	UNIVERSAL - IT DOES NOT REQUIRE ADAPTOR		3770N	(*)
CB1000R NEO SPORTS CAFE	18' - 20'	UNIVERSAL - IT DOES NOT REQUIRE ADAPTOR		3770N	(*)
CB500	93' - 04'	UNIVERSAL - IT DOES NOT REQUIRE ADAPTOR		3770N	(*)
CB500F	13' - 20'	UNIVERSAL - IT DOES NOT REQUIRE ADAPTOR		3770N	(*)
CB500X	13' - 20'	UNIVERSAL - IT DOES NOT REQUIRE ADAPTOR		3770N	(*)
CB600F HORNET	98' - 15'	UNIVERSAL - IT DOES NOT REQUIRE ADAPTOR		3770N	(*)
CB650F	14' - 20'	UNIVERSAL - IT DOES NOT REQUIRE ADAPTOR		3770N	(*)
CB750	93' - 03'	UNIVERSAL - IT DOES NOT REQUIRE ADAPTOR		3770N	(*)
CB900F HORNET	02' - 05'	UNIVERSAL - IT DOES NOT REQUIRE ADAPTOR		3770N	(*)
CB1000R	08' - 16'	UNIVERSAL - IT DOES NOT REQUIRE ADAPTOR		3770N	(*)
CB1100EX	14' - 20'	UNIVERSAL - IT DOES NOT REQUIRE ADAPTOR		3770N	(*)
CB1100RS	17' - 20'	UNIVERSAL - IT DOES NOT REQUIRE ADAPTOR		3770N	(*)
CB1300	03'	UNIVERSAL - IT DOES NOT REQUIRE ADAPTOR		3770N	(*)
CBF250	04' - 16'	UNIVERSAL - IT DOES NOT REQUIRE ADAPTOR		3770N	(*)
CBF500	04' - 07'	UNIVERSAL - IT DOES NOT REQUIRE ADAPTOR		3770N	(*)
CBF600	04' - 14'	UNIVERSAL - IT DOES NOT REQUIRE ADAPTOR		3770N	(*)
CBF600S	08' - 14'	UNIVERSAL - IT DOES NOT REQUIRE ADAPTOR		3770N	(*)
CBF1000	06' - 11'	UNIVERSAL - IT DOES NOT REQUIRE ADAPTOR		3770N	(*)

N
Black

(*) Check price with your distributor.

IMPORTANT: Indicate code color after part#. Example 0973A

BRAKE / CLUTCH LEVER PROTECTOR ADAPTORS

HI-TECH PARTS



2021 MODELS: www.puig.tv

MODEL	YEAR	ADAPTOR REF.	N	LEFT SIDE BAR END REF.	N
CBR125R	11' - 16'	UNIVERSAL - IT DOES NOT REQUIRE ADAPTOR		3770N	(*)
CBR250R	11' - 15'	UNIVERSAL - IT DOES NOT REQUIRE ADAPTOR		3770N	(*)
CBR500R	13' - 20'	UNIVERSAL - IT DOES NOT REQUIRE ADAPTOR		3770N	(*)
CBR600RR	03' - 16'	UNIVERSAL - IT DOES NOT REQUIRE ADAPTOR		3770N	(*)
CBR600F	99' - 07'	UNIVERSAL - IT DOES NOT REQUIRE ADAPTOR		3770N	(*)
CBR600F	11' - 13'	UNIVERSAL - IT DOES NOT REQUIRE ADAPTOR		3770N	(*)
CBR650F	14' - 19'	UNIVERSAL - IT DOES NOT REQUIRE ADAPTOR		3770N	(*)
CBR650R	19' - 20'	UNIVERSAL - IT DOES NOT REQUIRE ADAPTOR		3770N	(*)
CBR900RR FIREBLADE	00' - 03'	UNIVERSAL - IT DOES NOT REQUIRE ADAPTOR		3770N	(*)
CBR1000RR FIREBLADE	04' - 13'	UNIVERSAL - IT DOES NOT REQUIRE ADAPTOR		3770N	(*)
CBR1000RR FIREBLADE /SP	14' - 16'	UNIVERSAL - IT DOES NOT REQUIRE ADAPTOR		3770N	(*)
CBR1000RR FIREBLADE/SP/SP2	17' - 19'	UNIVERSAL - IT DOES NOT REQUIRE ADAPTOR		3770N	(*)
CBR1000RR FIREBLADE /SP	20'	UNIVERSAL - IT DOES NOT REQUIRE ADAPTOR		3770N	(*)
CBR1000F	94' - 00'	UNIVERSAL - IT DOES NOT REQUIRE ADAPTOR		3770N	(*)
CBR1100XX BLACKBIRD	97' - 07'	UNIVERSAL - IT DOES NOT REQUIRE ADAPTOR		3770N	(*)
CROSSRUNNER	15' - 20'	UNIVERSAL - IT DOES NOT REQUIRE ADAPTOR		3770N	(*)
INTEGRA 700	12' - 13'	UNIVERSAL - IT DOES NOT REQUIRE ADAPTOR		3770N	(*)
INTEGRA 750	14' - 15'	UNIVERSAL - IT DOES NOT REQUIRE ADAPTOR		3770N	(*)
INTEGRA 750S	14' - 15'	UNIVERSAL - IT DOES NOT REQUIRE ADAPTOR		3770N	(*)
INTEGRA 750S	16' - 19'	UNIVERSAL - IT DOES NOT REQUIRE ADAPTOR		3770N	(*)
MSX125	14' - 20'	UNIVERSAL - IT DOES NOT REQUIRE ADAPTOR		3770N	(*)
NC700S/X	12' - 13'	UNIVERSAL - IT DOES NOT REQUIRE ADAPTOR		3770N	(*)
NC750S/X	14' - 15'	UNIVERSAL - IT DOES NOT REQUIRE ADAPTOR		3770N	(*)
NC750S/X	16' - 20'	UNIVERSAL - IT DOES NOT REQUIRE ADAPTOR		3770N	(*)
PCX 125	10' - 20'	UNIVERSAL - IT DOES NOT REQUIRE ADAPTOR		3770N	(*)
VFR800F	14' - 18'	UNIVERSAL - IT DOES NOT REQUIRE ADAPTOR		3770N	(*)
VFR1200F	10' - 16'	UNIVERSAL - IT DOES NOT REQUIRE ADAPTOR		3770N	(*)
VTR1000F FIRE STORM	97' - 07'	UNIVERSAL - IT DOES NOT REQUIRE ADAPTOR		3770N	(*)
X-ELEVEN	99' - 03'	UNIVERSAL - IT DOES NOT REQUIRE ADAPTOR		3770N	(*)
INDIAN					
FTR 1200	19' - 20'	UNIVERSAL - IT DOES NOT REQUIRE ADAPTOR		3770N	(*)
FTR 1200 S	19' - 20'	UNIVERSAL - IT DOES NOT REQUIRE ADAPTOR		3770N	(*)
KAWASAKI					
ER-6N	05' - 16'	9584N	(*)	9584N	(*)
ER-6F	09' - 16'	9584N	(*)	9584N	(*)
NINJA 125	19' - 20'	9584N	(*)	9584N	(*)
NINJA 300	13' - 17'	9584N	(*)	9584N	(*)
NINJA 400	18' - 20'	9584N	(*)	9584N	(*)
NINJA 650	20'	UNIVERSAL - IT DOES NOT REQUIRE ADAPTOR		3770N	(*)
NINJA H2	15' - 20'	3809N	(*)		

2021 MODELS: www.puig.tv

MODEL	YEAR	ADAPTOR REF.	N	LEFT SIDE BAR END REF.	N
NINJA H2 SX	18' - 20'	UNIVERSAL - IT DOES NOT REQUIRE ADAPTOR		3770N	(*)
NINJA 1000 SX	20'	9584N	(*)	9584N	(*)
VERSYS 650	07' - 20'	9584N	(*)	9584N	(*)
VERSYS 1000	12' - 20'	9584N	(*)	9584N	(*)
VULCAN S	15' - 20'	9584N	(*)	9584N	(*)
VULCAN S CAFE	17' - 20'	9584N	(*)	9584N	(*)
W800	11' - 16'	9584N	(*)	9584N	(*)
Z125	17' - 20'	9584N	(*)	9584N	(*)
Z300	15' - 17'	9584N	(*)	9584N	(*)
Z400	19' - 20'	9584N	(*)	9584N	(*)
Z650	17' - 20'	UNIVERSAL - IT DOES NOT REQUIRE ADAPTOR		3770N	(*)
Z750	04' - 12'	9584N	(*)	9584N	(*)
Z750R	11' - 12'	9584N	(*)	9584N	(*)
Z800/E	13' - 16'	9584N	(*)	9584N	(*)
Z900	17' - 20'	9584N	(*)	9584N	(*)
Z900RS	18' - 20'	9584N	(*)	9584N	(*)
Z900RS CAFÉ	18' - 20'	9584N	(*)	9584N	(*)
Z1000	03' - 20'	9584N	(*)	9584N	(*)
Z1000R	17' - 20'	9584N	(*)	9584N	(*)
Z1000SX	11' - 20'	9584N	(*)	9584N	(*)
ZR7	99' - 03'	9584N	(*)	9584N	(*)
ZR7S	01' - 03'	9584N	(*)	9584N	(*)
ZRX1100	97' - 01'	9584N	(*)	9584N	(*)
ZRX1200S	01' - 07'	9584N	(*)	9584N	(*)
ZX-6R	99' - 06'	9584N	(*)	9584N	(*)
ZX-6R	09' - 16'	9584N	(*)	9584N	(*)
ZX-6R	18' - 20'	9584N	(*)	9584N	(*)
ZX-6R 636	13' - 16'	9584N	(*)	9584N	(*)
ZX-7R	96' - 01'	9584N	(*)	9584N	(*)
ZX-9R	94' - 04'	9584N	(*)	9584N	(*)
ZX-10R	11' - 15'	9584N	(*)	9584N	(*)
ZX-10R	16' - 20'	3778N	(*)	3778N	(*)
ZX-10RR	17' - 20'	3778N	(*)	3778N	(*)
ZX-10R SE	18' - 20'	3778N	(*)	3778N	(*)
ZX-12R	00' - 06'	9584N	(*)	9584N	(*)
ZZR600	93' - 05'	9584N	(*)	9584N	(*)
ZZR1100	93' - 01'	9584N	(*)	9584N	(*)
ZZR1400	06' - 20'	9584N	(*)	9584N	(*)
KTM					
125 DUKE	11' - 20'	UNIVERSAL - IT DOES NOT REQUIRE ADAPTOR		3770N	(*)
390 DUKE	13' - 16'	UNIVERSAL - IT DOES NOT REQUIRE ADAPTOR		3770N	(*)

N
Black

(*) Check price with your distributor.

IMPORTANT: Indicate code color after part#. Example 0973A

BRAKE / CLUTCH LEVER PROTECTOR ADAPTORS

HI-TECH PARTS



2021 MODELS: www.puig.tv

MODEL	YEAR	ADAPTOR REF.	N	LEFT SIDE BAR END REF.	N
690 DUKE	12' - 20'	UNIVERSAL - IT DOES NOT REQUIRE ADAPTOR		3770N	(*)
690 DUKE R	12' - 17'	UNIVERSAL - IT DOES NOT REQUIRE ADAPTOR		3770N	(*)
790 DUKE	18' - 20'	UNIVERSAL - IT DOES NOT REQUIRE ADAPTOR		3770N	(*)
1290 SUPERDUKE R	14' - 20'	UNIVERSAL - IT DOES NOT REQUIRE ADAPTOR		3770N	(*)
1290 SUPERDUKE GT	16' - 19'	UNIVERSAL - IT DOES NOT REQUIRE ADAPTOR		3770N	(*)
RC125/390	14' - 20'	UNIVERSAL - IT DOES NOT REQUIRE ADAPTOR		3770N	(*)
KYMCO					
AK550	17' - 20'	20486N	(*)		
SUZUKI					
B-KING	08' - 11'	9582N	(*)	3774N	(*)
BURGMAN 400	17' - 20'	9582N	(*)	3774N	(*)
DL250 V-STROM	17' - 20'	9582N	(*)	3774N	(*)
DL1050 V-STROM	20'	9582N	(*)	3774N	(*)
DL1050XT V-STROM	20'	9582N	(*)	3774N	(*)
GS500	01' - 07'	9582N	(*)	3774N	(*)
GS500F	04' - 07'	9582N	(*)	3774N	(*)
GSF600 BANDIT	96' - 06'	9582N	(*)	3774N	(*)
GSF600S BANDIT	96' - 04'	9582N	(*)	3774N	(*)
GSF1200 BANDIT/S	96' - 06'	9582N	(*)	3774N	(*)
GSR600	06' - 11'	9582N	(*)	3774N	(*)
GSR750	11' - 16'	9582N	(*)	3774N	(*)
GSX-R125	17' - 20'	9582N	(*)	3774N	(*)
GSX-R250	17' - 20'	9582N	(*)	3774N	(*)
GSX-R600	96' - 05'	9582N	(*)	3774N	(*)
GSX-R600	06' - 16'	9582N	(*)	3774N	(*)
GSX-R750	96' - 05'	9582N	(*)	3774N	(*)
GSX-R1000	01' - 16'	9582N	(*)	3774N	(*)
GSX-R1000/R	17' - 20'	3804N	(*)	3805N	(*)
GSX-S750	17' - 20'	9427N	(*)	3774N	(*)
GSX-S1000	15' - 20'	9582N	(*)	3774N	(*)
GSX-S1000F	15' - 20'	9582N	(*)	3774N	(*)
GSX750F	92' - 97'	9582N	(*)	3774N	(*)
GSX1200	99' - 00'	9582N	(*)	3774N	(*)
GSX1400	01' - 06'	9582N	(*)	3774N	(*)
INAZUMA	13' - 17'	9582N	(*)	3774N	(*)
KATANA	19' - 20'	9582N	(*)	3774N	(*)
SFV650 GLADIUS	09' - 15'	9582N	(*)	3774N	(*)
SV650	05' - 08'	9582N	(*)	3774N	(*)
SV650S	03' - 08'	9582N	(*)	3774N	(*)
SV650	16' - 20'	9582N	(*)	3774N	(*)

2021 MODELS: www.puig.tv

MODEL	YEAR	ADAPTOR REF.	N	LEFT SIDE BAR END REF.	N
SV650X	18' - 20'	9582N	(*)	3774N	(*)
SV1000/S	03' - 05'	9582N	(*)	3774N	(*)
TL1000R	98' - 99'	9582N	(*)	3774N	(*)
TL1000S	97' - 00'	9582N	(*)	3774N	(*)
TRIUMPH					
BONNEVILLE T100	16' - 19'	9500N	(*)	9500N	(*)
BONNEVILLE T120	16' - 19'	9500N	(*)	9500N	(*)
SCRAMBLER 1200XC	19' - 20'	9500N	(*)	9500N	(*)
STREET SCRAMBLER	17' - 20'	9500N	(*)	9500N	(*)
STREET TWIN	16' - 20'	9500N	(*)	9500N	(*)
YAMAHA					
FZ6	04' - 08'	9583P	(*)	3771N	(*)
MT-125	14' - 20'	9583P	(*)	3771N	(*)
MT-03	16' - 19'	20310N	(*)	20311N	(*)
MT-03	20'	20310N	(*)	20311N	(*)
MT-07	14' - 20'	9583P	(*)	3771N	(*)
MT-09	13' - 20'	9583P	(*)	3771N	(*)
MT-09 SP	18' - 20'	9583P	(*)	3771N	(*)
MT-10	16' - 20'	9583P	(*)	3771N	(*)
MT-10 SP	17' - 20'	9583P	(*)	3771N	(*)
TDM 900	03' - 13'	9583P	(*)	3771N	(*)
T-MAX 530	12' - 16'	9583P	(*)	3771N	(*)
T-MAX 530/DX/SX	17' - 19'	9583P	(*)	3771N	(*)
T.MAX 560 /SX/DX/MAX TECH	20'	9583P	(*)	3771N	(*)
XJ6	09' - 16'	9583P	(*)	3771N	(*)
XJR1300	99' - 13'	9583P	(*)	3771N	(*)
X-MAX 125 (M16)	10' - 16'	9583P	(*)	3771N	(*)
X-MAX 250 (M16)	10' - 16'	9583P	(*)	3771N	(*)
X-MAX 400	13' - 20'	9583P	(*)	3771N	(*)
XSR700	16' - 20'	9583P	(*)	3771N	(*)
XSR700 XTRIBUTE	19' - 20'	9583P	(*)	3771N	(*)
XSR900	16' - 20'	9583P	(*)	3771N	(*)
YZF-R1	98' - 14'	3800N	(*)	3800N	(*)
YZF-R1	15' - 20'	3801N	(*)	3801N	(*)
YZF-R1 M	17' - 20'	3801N	(*)	3801N	(*)
YZF-R3	15' - 20'	UNIVERSAL - IT DOES NOT REQUIRE ADAPTOR		3770N	(*)
YZF-R6	06' - 16'	3800N	(*)	3800N	(*)
YZF-R6	17' - 20'	3801N	(*)	3801N	(*)

N
Black

(*) Check price with your distributor.

IMPORTANT: Indicate code color after part#. Example 0973A

SCOOTER LEVERS
HI-TECH PARTS | TECHNICAL SECTION

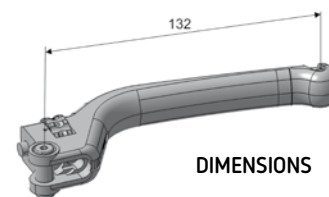

DIMENSIONS

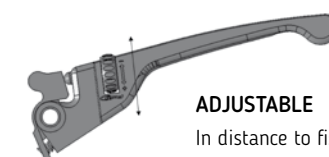

ADJUSTABLE
In distance to fist.

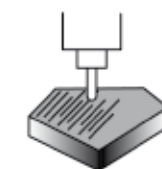

MACHINED
Machined from billet aluminium and anodized in colors.



MODEL	YEAR	FRONT BRAKE LEVER	N	REAR BRAKE LEVER	N
HONDA					
FORZA 125	20'	20394	(*)	20394	(*)
SCOOPHY SH125i	17' - 20'	20394	(*)	20394	(*)
PIAGGIO					
VESPA GTS300	08' - 20'	20366	(*)	20366	(*)

ADAPTORS INCLUDED WHEN REQUESTING THE LEVER REFERENCE.

(*) Check price with your distributor.

IMPORTANT: Indicate code color after part#. Example 0973A

HERITAGE LEVERS

HI-TECH PARTS | TECHNICAL SECTION

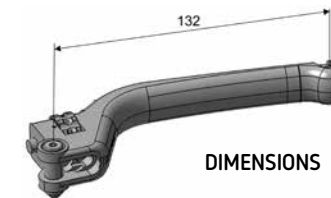

DIMENSIONS

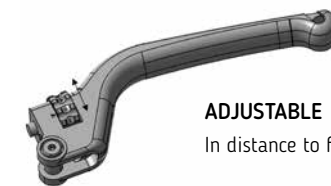

ADJUSTABLE
In distance to fist.

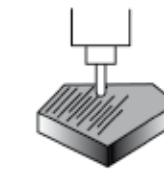

MACHINED
Machined from billet aluminium and anodized in colors.



100gr.



N
Black



REF. 9995N

NON-FOLDABLE MODEL	REF.	N
UNFOLDABLE BRAKE LEVER	9995N	(*)
ADAPTOR BRAKE LEVER	SEE CHART BELOW	
UNFOLDABLE CLUTCH LEVER	9996N	(*)
ADAPTOR CLUTCH LEVER	SEE CHART BELOW	

MODEL	YEAR	CLUTCH LEVER ADAPTER	N	BRAKE LEVER ADAPTER	N
HARLEY DAVIDSON					
SPORTSTER 883 IRON	16' - 20'	9645N	(*)	9648N	(*)
HONDA					
CMX 500 REBEL	17' - 20'	9649N	(*)	9646N	(*)
INDIAN					
SCOUT	15' - 20'	9742N	(*)	9743N	(*)
SCOUT BOBBER	18' - 20'	9742N	(*)	9743N	(*)
KAWASAKI					
VULCAN S	15' - 20'	9642N	(*)	9647N	(*)
VULCAN S CAFE	17' - 20'	9642N	(*)	9647N	(*)
TRIUMPH					
BONNEVILLE BOBBER	17' - 20'	9643N	(*)	9650N	(*)
YAMAHA					
SCR 950	17' - 20'	0391N	(*)	1000N	(*)
XV950	14' - 20'	9644N	(*)	9651N	(*)
XV950R	14' - 20'	9644N	(*)	9651N	(*)
XV950 RACER	14' - 20'	0391N	(*)	1000N	(*)

IMPORTANT: Indicate code color after part#. Example 0973A

OFF-ROAD LEVERS

HI-TECH PARTS | TECHNICAL SECTION

FOLDS OUTWARD

Adaptor designed with spring which allows the lever to swing forward to avoid the lever to twist or break.

DESIGN

Exclusive design: Clutch lever length of lever for 4 fingers. Brake lever length for 3 fingers.

REGULATION

The adjustable system allows to adjust the position for rider's needs.



N
Black

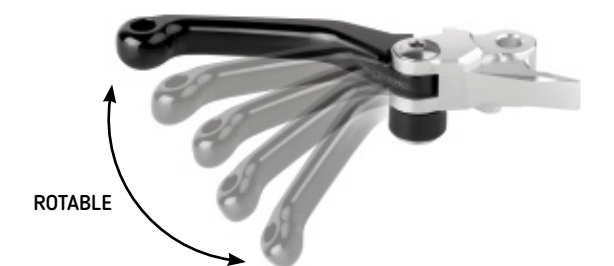

OFF-ROAD LEVER	REF.	
BRAKE LEVER WITH ADAPTOR (1)	SEE PAGE 196	
CLUTCH LEVER WITH ADAPTOR (2)	SEE PAGE 196	
SPARES	REF.	N
BRAKE LEVER	88888N	(*)
CLUTCH LEVER	99999N	(*)

(*) Check price with your distributor.

OFF-ROAD LEVERS

HI-TECH PARTS

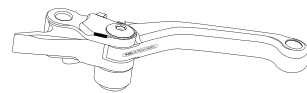
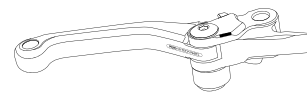

2021 MODELS: www.puig.tv

MODEL	YEAR	CLUTCH LEVER + ADAPTOR	N	BRAKE LEVER + ADAPTOR	N
BETA					
RR 2T	13'-19'	20012N	(*)	20018N	(*)
RR/RS 4T	12'-19'	20012N	(*)	20018N	(*)
X-TRAINER	15'-18'	20012N	(*)	20018N	(*)
GAS GAS					
EC 2T	00'-16'	20043N	(*)	20018N	(*)
EC 4T	10'-13'	20043N	(*)	20018N	(*)
EC250 E4	17'	20013N	(*)	20018N	(*)
EC300 E4	17'	20013N	(*)	20018N	(*)
FSE	03'-09'	20043N	(*)	20018N	(*)
FSR	03'-09'	20043N	(*)	20018N	(*)
XC250	17'	20013N	(*)	20018N	(*)
XC300	17'	20013N	(*)	20018N	(*)
HONDA					
CR80R	98'-07'	20001N	(*)	20018N	(*)
CR85R	98'-07'	20001N	(*)	20018N	(*)
CR125R	92'-03'	20001N	(*)	20018N	(*)
CR125R	04'-07'	20002N	(*)	20018N	(*)
CR250R	92'-03'	20001N	(*)	20018N	(*)
CR250R	04'-07'	20002N	(*)	20018N	(*)
CRF150F	03'-17'	20003N	(*)	20018N	(*)
CRF150R	07'-19'	20001N	(*)	20018N	(*)
CRF230F	03'-17'	20003N	(*)	20018N	(*)
CRF250R	04'-06'	20002N	(*)	20018N	(*)
CRF250R	07'-19'	20002N	(*)	20019N	(*)
CRF250RX	19'	20002N	(*)	20018N	(*)
CRF250X	04'-17'	20002N	(*)	20018N	(*)
CRF450R	02'-03'	20001N	(*)	20018N	(*)
CRF450R	04'-06'	20002N	(*)	20018N	(*)
CRF450R	07'-19'	20002N	(*)	20019N	(*)
CRF450RX	17'-19'	20002N	(*)	20019N	(*)
CRF450X	05'-17'	20002N	(*)	20018N	(*)
XR230	05'-12'	20003N	(*)	20015N	(*)
XR230 MOTARD	05'-12'	20003N	(*)	20015N	(*)
XR250	95'-07'	20001N	(*)	20015N	(*)
XR250 MOTARD	95'-07'	20001N	(*)	20015N	(*)
XR400	05'-08'	20001N	(*)	20015N	(*)
XR400 MOTARD	05'-08'	20001N	(*)	20015N	(*)
HUSQVARNA					
RC250 - FREIN BREMBO	18'	20013N	(*)	20014N	(*)
RC250 - FREIN MAGURA	18'	20013N	(*)	20046N	(*)
FC 250	14'-15'	20012N	(*)	20014N	(*)

2021 MODELS: www.puig.tv

MODEL	YEAR	CLUTCH LEVER + ADAPTOR	N	BRAKE LEVER + ADAPTOR	N
FC 250	16'-19'	20013N	(*)	20014N	(*)
FC 250 - FREIN BREMBO	18'	20013N	(*)	20014N	(*)
FC 250 - FREIN MAGURA	18'	20013N	(*)	20018N	(*)
FC 350	14'-15'	20012N	(*)	20018N	(*)
FC 350	16'-19'	20013N	(*)	20018N	(*)
FC 350 - FREIN BREMBO	18'	20013N	(*)	20018N	(*)
FC 350 - FREIN MAGURA	18'	20013N	(*)	20018N	(*)
FC 450	14'-15'	20012N	(*)	20014N	(*)
FC 450	16'-17'	20013N	(*)	20014N	(*)
FC 450 - FREIN BREMBO	18'	20013N	(*)	20014N	(*)
FC 450 - FREIN MAGURA	18'	20013N	(*)	20046N	(*)
FE 250	14'-16'	20012N	(*)	20014N	(*)
FE 250	17'-19'	20013N	(*)	20014N	(*)
FE 501	14'-16'	20012N	(*)	20014N	(*)
FE 501	17'-19'	20013N	(*)	20014N	(*)
FE 501S	14'-16'	20012N	(*)	20014N	(*)
FE 501S	17'-19'	20013N	(*)	20014N	(*)
TE125	14'-16'	20013N	(*)	20014N	(*)
TE250	14'-16'	20012N	(*)	20014N	(*)
TE250	14'-16'	20013N	(*)	20014N	(*)
TE300	14'-16'	20012N	(*)	20014N	(*)
TE300	17'	20013N	(*)	20014N	(*)
TC65	17'-19'	20044N	(*)	20045N	(*)
TC85	14'-19'	20044N	(*)	20045N	(*)
TC125	14'-19'	20013N	(*)	20014N	(*)
TC125 - FREIN BREMBO	18'	20013N	(*)	20014N	(*)
TC125 - FREIN MAGURA	18'	20013N	(*)	20046N	(*)
TC250	14'-19'	20013N	(*)	20014N	(*)
KAWASAKI					
KX65	00'-19'	20008N	(*)	20020N	(*)
KX85	01'-19'	20008N	(*)	20020N	(*)
KX100	01'-19'	20008N	(*)	20020N	(*)
KX125	00'-05'	20008N	(*)	20020N	(*)
KX125	06'-08'	20009N	(*)	20020N	(*)
KX250	00'-04'	20008N	(*)	20020N	(*)
KX250	05'-08'	20009N	(*)	20020N	(*)
KX250	19'	20009N	(*)	20018N	(*)
KX250F	04'	20008N	(*)	20020N	(*)
KX250F	05'-12'	20009N	(*)	20020N	(*)
KX250F	13'-18'	20009N	(*)	20021N	(*)
KX450F	06'-12'	20009N	(*)	20020N	(*)
KX450F	13'-18'	20009N	(*)	20021N	(*)

N
Black

(*) Check price with your distributor.

IMPORTANT: Indicate code color after part#. Example: 0973A.

OFF-ROAD LEVERS

HI-TECH PARTS



2021 MODELS: www.puig.tv

MODEL	YEAR	CLUTCH LEVER + ADAPTOR	N	BRAKE LEVER + ADAPTOR	N
KX450	19'	20210N	(*)	20211N	(*)
KLX450R	08'-15'	20006N	(*)	20020N	(*)
KTM					
65SX	04'-11'	20007N	(*)	20024N	(*)
65SX	14'-19'	20044N	(*)	20045N	(*)
65XC	04'-11'	20007N	(*)	20024N	(*)
65XC	14'-18'	20044N	(*)	20045N	(*)
85SX	03'-12'	20007N	(*)	20024N	(*)
85SX	14'-19'	20044N	(*)	20045N	(*)
85XC	03'-11'	20007N	(*)	20024N	(*)
85XC	14'-18'	20044N	(*)	20045N	(*)
125EXC	05'-08'	20007N	(*)	20023N	(*)
125EXC	09'-13'	20013N	(*)	20023N	(*)
125EXC	14'-16'	20013N	(*)	20014N	(*)
125SX	05'-08'	20007N	(*)	20023N	(*)
125SX	09'-13'	20013N	(*)	20023N	(*)
125SX	14'-15'	20013N	(*)	20014N	(*)
125SX	16'-19'	20012N	(*)	20014N	(*)
125XC-W	17'-19'	20012N	(*)	20018N	(*)
144SX	07'-08'	20007N	(*)	20023N	(*)
150SX	09'-11'	20013N	(*)	20023N	(*)
150SX	12'-13'	20013N	(*)	20023N	(*)
150SX	14'-15'	20013N	(*)	20014N	(*)
150SX	16'-18'	20012N	(*)	20014N	(*)
150XC	09'-11'	20013N	(*)	20023N	(*)
150XC	12'-13'	20013N	(*)	20023N	(*)
150XC	14'-15'	20013N	(*)	20014N	(*)
150XC	16'-18'	20012N	(*)	20014N	(*)
150XC-W	17'-19'	20012N	(*)	20018N	(*)
200XC-W	05'-08'	20007N	(*)	20023N	(*)
200XC-W	09'-13'	20013N	(*)	20023N	(*)
200XC-W	14'-16'	20013N	(*)	20014N	(*)
200EXC	05'-08'	20007N	(*)	20023N	(*)
200EXC	09'-13'	20013N	(*)	20023N	(*)
200EXC	14'-16'	20013N	(*)	20014N	(*)
250EXC (SIX DAYS)	03'-04'	20007N	(*)	20023N	(*)
250EXC (SIX DAYS)	05'	20007N	(*)	20023N	(*)
250EXC (SIX DAYS)	06'-13'	20012N	(*)	20023N	(*)
250EXC (SIX DAYS)	14'-19'	20012N	(*)	20018N	(*)
250EXC-F (SIX DAYS)	03'-04'	20007N	(*)	20014N	(*)
250EXC-F (SIX DAYS)	05'	20007N	(*)	20023N	(*)
250EXC-F (SIX DAYS)	06'-13'	20012N	(*)	20023N	(*)

2021 MODELS: www.puig.tv

MODEL	YEAR	CLUTCH LEVER + ADAPTOR	N	BRAKE LEVER + ADAPTOR	N
250EXC-F (SIX DAYS)	14'-19'	20012N	(*)	20014N	(*)
250 FREERIDE R	14'-17'	20044N	(*)	20045N	(*)
250SX-F	05'-06'	20007N	(*)	20023N	(*)
250SX-F	07'-13'	20012N	(*)	20023N	(*)
250SX-F	14'-19'	20012N	(*)	20014N	(*)
250SX	03'-04'	20007N	(*)	20018N	(*)
250SX	05'	20007N	(*)	20023N	(*)
250SX	06'-13'	20012N	(*)	20023N	(*)
250SX	14'-19'	20012N	(*)	20014N	(*)
250XC	06'-13'	20012N	(*)	20023N	(*)
250XC	14'-19'	20012N	(*)	20014N	(*)
250XC-F	07'-13'	20012N	(*)	20023N	(*)
250XC-F	14'-19'	20012N	(*)	20014N	(*)
250XCF-W	07'-13'	20012N	(*)	20023N	(*)
250XCF-W	14'-19'	20012N	(*)	20014N	(*)
250XC-W	06'-13'	20012N	(*)	20023N	(*)
250XC-W	14'-19'	20012N	(*)	20014N	(*)
300XC-W	06'-13'	20012N	(*)	20023N	(*)
300XC-W	14'-19'	20012N	(*)	20014N	(*)
300EXC (SIX DAYS)	05'	20007N	(*)	20023N	(*)
300EXC (SIX DAYS)	06'-13'	20012N	(*)	20023N	(*)
300EXC (SIX DAYS)	14'-17'	20012N	(*)	20014N	(*)
300XC	06'-13'	20012N	(*)	20023N	(*)
300XC	14'-19'	20012N	(*)	20014N	(*)
350 FREERIDE	14'-17'	20044N	(*)	20045N	(*)
350SX-F(SIX DAYS)	11'-13'	20012N	(*)	20023N	(*)
350SX-F(SIX DAYS)	14'-19'	20012N	(*)	20014N	(*)
350XC-F(SIX DAYS)	11'-13'	20012N	(*)	20023N	(*)
350XC-F(SIX DAYS)	14'-19'	20012N	(*)	20014N	(*)
350XCF-W(SIX DAYS)	11'-13'	20012N	(*)	20023N	(*)
350XCF-W(SIX DAYS)	14'-18'	20012N	(*)	20014N	(*)
350EXC-F(SIX DAYS)	11'-13'	20012N	(*)	20023N	(*)
350EXC-F(SIX DAYS)	14'-19'	20012N	(*)	20014N	(*)
400EXC	09'-11'	20012N	(*)	20023N	(*)
400EXC-R	05'-07'	20007N	(*)	20023N	(*)
400XC-W	09'-10'	20012N	(*)	20023N	(*)
450EXC (SIX DAYS)	05'-06'	20007N	(*)	20023N	(*)
450EXC (SIX DAYS)	07'-13'	20012N	(*)	20023N	(*)
450EXC (SIX DAYS)	14'-19'	20012N	(*)	20014N	(*)
450EXC-F (SIX DAYS)	05'-06'	20007N	(*)	20023N	(*)
450EXC-F (SIX DAYS)	07'-13'	20012N	(*)	20023N	(*)
450EXC-F (SIX DAYS)	14'-19'	20012N	(*)	20014N	(*)

N
Black

(*) Check price with your distributor.

IMPORTANT: Indicate code color after part#. Example: 0973A.

OFF-ROAD LEVERS

HI-TECH PARTS

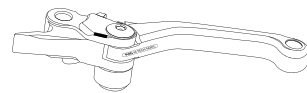
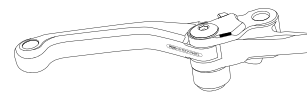

2021 MODELS: www.puig.tv

MODEL	YEAR	CLUTCH LEVER + ADAPTOR	N	BRAKE LEVER + ADAPTOR	N
450SMR	13'	20012N	(*)	20023N	(*)
450SX	05'-08'	20007N	(*)	20023N	(*)
450SX	09'-12'	20013N	(*)	20023N	(*)
450SX	13'	20012N	(*)	20023N	(*)
450SX	14'-19'	20012N	(*)	20014N	(*)
450SX-R	05'-08'	20007N	(*)	20023N	(*)
450SX-R	09'-12'	20013N	(*)	20023N	(*)
450SX-R	13'	20012N	(*)	20023N	(*)
450SX-R	14'-19'	20012N	(*)	20014N	(*)
450SX-F	05'-08'	20007N	(*)	20023N	(*)
450SX-F	09'-12'	20013N	(*)	20023N	(*)
450SX-F	13'	20012N	(*)	20023N	(*)
450SX-F	14'-19'	20012N	(*)	20014N	(*)
450XC	06'-07'	20007N	(*)	20023N	(*)
450XC-F	08'	20012N	(*)	20023N	(*)
450XC-F	09'	20007N	(*)	20023N	(*)
450XC-F	13'	20012N	(*)	20023N	(*)
450XC-F	14'-19'	20012N	(*)	20014N	(*)
450XC-W (SIX DAYS)	07'	20007N	(*)	20023N	(*)
450XC-W (SIX DAYS)	08'-13'	20012N	(*)	20023N	(*)
450XC-W (SIX DAYS)	14'-16'	20012N	(*)	20014N	(*)
450XCR-W (SIX DAYS)	07'	20007N	(*)	20023N	(*)
450XCR-W (SIX DAYS)	08'-13'	20012N	(*)	20023N	(*)
450XCR-W (SIX DAYS)	14'-16'	20012N	(*)	20014N	(*)
500XC-W (SIX DAYS)	12'-13'	20012N	(*)	20023N	(*)
500XC-W (SIX DAYS)	14'-19'	20012N	(*)	20014N	(*)
500EXC (SIX DAYS)	12'-13'	20012N	(*)	20023N	(*)
500EXC (SIX DAYS)	14'-19'	20012N	(*)	20014N	(*)
500EXC-F (SIX DAYS)	12'-13'	20012N	(*)	20023N	(*)
500EXC-F (SIX DAYS)	14'-19'	20012N	(*)	20014N	(*)
525SX	05'-07'	20007N	(*)	20023N	(*)
525SX-R	05'-07'	20007N	(*)	20023N	(*)
525XC	05'-07'	20007N	(*)	20023N	(*)
525XC-W	05'-07'	20007N	(*)	20023N	(*)
530EXC-R	08'-11'	20012N	(*)	20023N	(*)
530EXC	08'-11'	20012N	(*)	20023N	(*)
530XCR-W	08'-11'	20012N	(*)	20023N	(*)
530XCR-W	08'-11'	20012N	(*)	20023N	(*)
SUZUKI					
DRZ400 S	00'-17'	20004N	(*)	20016N	(*)
DRZ400 SM	00'-17'	20004N	(*)	20016N	(*)
RM85	05'-17'	20005N	(*)	20020N	(*)

2021 MODELS: www.puig.tv

MODEL	YEAR	CLUTCH LEVER + ADAPTOR	N	BRAKE LEVER + ADAPTOR	N
RM125	96'-03'	20005N	(*)	20018N	(*)
RM125	04'-08'	20005N	(*)	20020N	(*)
RM250	96'-03'	20005N	(*)	20018N	(*)
RM250	04'-08'	20005N	(*)	20020N	(*)
RMZ250	04'	20008N	(*)	20020N	(*)
RMZ250	05'-06'	20009N	(*)	20020N	(*)
RMZ250	07'-18'	20008N	(*)	20020N	(*)
RMZ450	04'	20008N	(*)	20018N	(*)
RMZ450	05'-18'	20008N	(*)	20020N	(*)
YAMAHA					
WR250F	05'-16'	20006N	(*)	20020N	(*)
WR250F	17'-18'	20006N	(*)	20021N	(*)
WR450F	05'-15'	20006N	(*)	20020N	(*)
WR450F	16'-18'	20006N	(*)	20021N	(*)
WR250R	07'-17'	20005N	(*)	20017N	(*)
WR250X	07'-17'	20005N	(*)	20017N	(*)
YZ65	18'	20010N	(*)	20018N	(*)
YZ80	01'-14'	20005N	(*)	20020N	(*)
YZ80	15'-19'	20010N	(*)	20020N	(*)
YZ85	01'-14'	20005N	(*)	20020N	(*)
YZ85	15'-19'	20010N	(*)	20020N	(*)
YZ125	01'-07'	20009N	(*)	20020N	(*)
YZ125	08'-14'	20009N	(*)	20021N	(*)
YZ125	15'-19'	20010N	(*)	20021N	(*)
YZ125X	17'-19'	20010N	(*)	20021N	(*)
YZ250	01'-07'	20009N	(*)	20020N	(*)
YZ250	08'-14'	20009N	(*)	20021N	(*)
YZ250	15'-19'	20010N	(*)	20021N	(*)
YZ250FX	01'-06'	20009N	(*)	20020N	(*)
YZ250FX	07'-08'	20009N	(*)	20021N	(*)
YZ250FX	09'-19'	20010N	(*)	20021N	(*)
YZ250FX	15'-19'	20010N	(*)	20021N	(*)
YZ250X	16'-19'	20010N	(*)	20021N	(*)
YZ426F	01'-07'	20009N	(*)	20020N	(*)
YZ426F	08'	20009N	(*)	20021N	(*)
YZ426F	09'-19'	20010N	(*)	20021N	(*)
YZ450F	01'-07'	20009N	(*)	20020N	(*)
YZ450F	08'	20009N	(*)	20021N	(*)
YZ450F	09'-19'	20010N	(*)	20021N	(*)
YZ450FX	16'-18'	20010N	(*)	20021N	(*)
YZ450FX	19'	20010N	(*)	20018N	(*)

N
Black

(*) Check price with your distributor.

IMPORTANT: Indicate code color after part#. Example: 0973A.



BRAKE-CLUTCH LIQUID TANK COVER
HI-TECH PARTS | TECHNICAL SECTION

REF. 9264V



LOOKS

Improves the looks of the bike adding a touch of exclusivity.

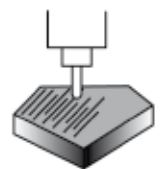

MACHINED

Machined from billet aluminium and anodized in colors.

FOR SPECIFIC MODELS SEE PAGE 204.



GLOVE FOR FRONT BRAKE TANK
HI-TECH PARTS | TECHNICAL SECTION

REF. 5208N



MODEL	REF.	N
GLOVE FOR FRONT BRAKE TANK	5208N	(*)



N
Black

(*) Check price with your distributor.
IMPORTANT: Indicate code color after part#. Example 0973A

BRAKE-CLUTCH LIQUID TANK COVER

HI-TECH PARTS

2021 MODELS: www.puig.tv

MODEL	YEAR	BRAKE LIQUID TANK COVER	R O A T N P V	CLUTCH LIQUID TANK COVER	R O A T N P V
BMW					
F650 GS	08' - 12'	9272	(*)		
F700 GS	12' - 17'	9272	(*)		
F750 GS	18' - 20'	9530	(*)		
F800 GT	13' - 20'	9272	(*)		
F800 GS	08' - 17'	9272	(*)		
F800R	09' - 20'	9272	(*)		
F850 GS	18' - 20'	9530	(*)		
F850 GS ADVENTURE	19' - 20'	9530	(*)		
F900XR	20'	9530	(*)		
G310R	16' - 20'	9612	(*)		
G310 GS	17' - 20'	9612	(*)		
R1200 R	15' - 18'	9273	(*)	9282	(*)
R1200 RS	15' - 18'	9273	(*)	9282	(*)
R1200 GS	13' - 18'	9273	(*)	9282	(*)
R1200GS EXCLUSIVE	17' - 18'	9273	(*)	9282	(*)
R1200GS RALLYE	17' - 18'	9273	(*)	9282	(*)
R1250GS	18' - 20'	9273	(*)	9282	(*)
R1250GS HP	18' - 20'	9273	(*)	9282	(*)
R1250GS ADVENTURE	18' - 20'	9273	(*)	9282	(*)
R1250R	19' - 20'	9273	(*)	9282	(*)
R1250RS	19' - 20'	9273	(*)	9282	(*)
R NINE T	14'	9273	(*)	9282	(*)
R NINE T (#)	15' - 16'	9273	(*)	9282	(*)
R NINE T (&)	15' - 16'	9530	(*)	9531	(*)
R NINE T	17' - 20'	9530	(*)	9531	(*)
R NINE T URBAN G/S	17' - 20'	9530	(*)	9531	(*)
R NINE T PURE	17' - 20'	9530	(*)	9531	(*)
R NINE T RACER	17' - 20'	9530	(*)	9531	(*)
S1000 R	14' - 20'	9264	(*)		
S1000 RR	19' - 20'	9264	(*)		
S1000 RR	15' - 18'	9264	(*)		
S1000 RR	19' - 20'	9264	(*)		
S1000 XR	20'	9530	(*)		
DUCATI					
HYPERMOTARD 821/SP	13' - 15'	9499	(*)		
HYPERMOTARD 939/SP	16' - 19'	9499	(*)		
HYPERSTRADA	13' - 15'	9499	(*)		
MONSTER 696	08' - 14'	9499	(*)		
MONSTER 796	10' - 14'	9499	(*)		
MONSTER 797	17' - 20'	9499	(*)		

2021 MODELS: www.puig.tv

MODEL	YEAR	BRAKE LIQUID TANK COVER	R O A T N P V	CLUTCH LIQUID TANK COVER	R O A T N P V
MONSTER 821	14' - 20'	9499	(*)		
MULTISTRADA 950	17' - 20'	9499	(*)		
SCRAMBLER ICON/CLASSIC/FULL THROTTLE	15' - 20'	9499	(*)		
SCRAMBLER SIXTY2	16' - 20'	9499	(*)		
SCRAMBLER URBAN ENDURO	15' - 16'	9499	(*)		
SCRAMBLER FLAT TRACK PRO	16'	9499	(*)		
SCRAMBLER 1100	18' - 20'	9499	(*)	9540	(*)
SCRAMBLER 1100 SPORT	18' - 20'	9499	(*)	9540	(*)
SCRAMBLER 1100 SPECIAL	18' - 20'	9499	(*)	9540	(*)
HONDA					
CB125R NEO SPORTS CAFE	18' - 20'	9274	(*)		
CB300R NEO SPORTS CAFE	18' - 20'	9274	(*)		
CB500F	13' - 20'	9274	(*)		
CB500X	13' - 20'	9274	(*)		
CB600F HORNET	98' - 06'	9262	(*)		
CB600F HORNET	07' - 15'	9262	(*)		
CB650F	14' - 20'	9262	(*)		
CB650R NEO SPORTS CAFÉ	19' - 20'	9262	(*)		
CB900F HORNET	02' - 05'	9262	(*)		
CB1000R	08' - 16'	9264	(*)	9262	(*)
CB1000R NEO SPORTS CAFE	18' - 20'	9758	(*)		
CB1100	13' - 14'	9262	(*)	9262	(*)
CB1100EX	14' - 20'	9262	(*)	9262	(*)
CB1100RS	17' - 20'	9262	(*)	9262	(*)
CB1300	02' - 10'	9262	(*)	9262	(*)
CBF600/S	04' - 07'	9262	(*)		
CBF600/S	08' - 14'	9262	(*)		
CBR250R	11' - 14'	9274	(*)		
CBR500R	13' - 20'	9274	(*)		
CBR600F	86' - 07'	9262	(*)		
CBR600F	11' - 13'	9262	(*)		
CBR600RR	07' - 09'	9264	(*)		
CBR650F	14' - 19'	9262	(*)		
CBR650R	19' - 20'	9262	(*)		
CBR900RR FIRE BLADE	98' - 99'	9262	(*)		
CBR1000RR FIRE BLADE	04' - 07'	9264	(*)		
CBR1000RR FIRE BLADE	08' - 11'	9264	(*)		
CBR1000RR FIRE BLADE	12' - 16'	9264	(*)		

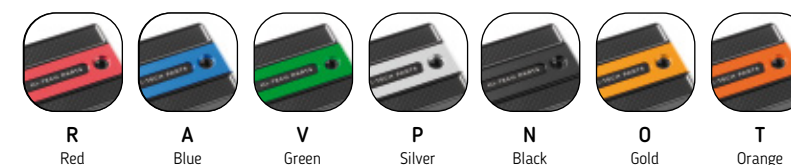

(*) Check price with your distributor.
 (#) BMW R NINE T with production code 0A6, 0A16
 (&) BMW R NINE T with production code 0J01, 0J03
IMPORTANT: Indicate code color after part#. Example 0973A

BRAKE-CLUTCH LIQUID TANK COVER

HI-TECH PARTS

2021 MODELS: www.puig.tv

MODEL	YEAR	BRAKE LIQUID TANK COVER	R O A T N P V	CLUTCH LIQUID TANK COVER	R O A T N P V
CBR1000RR FIREBLADE/SP/SP2	17' - 19'	9264	(*)		
CBR1000RR FIREBLADE/SP	20'	9264	(*)		
CROSSRUNNER	11' - 20'	9262	(*)	9262	(*)
CROSSTOURER	12' - 20'	9262	(*)	9262	(*)
INTEGRA 700	12' - 13'	9262	(*)	9262	(*)
INTEGRA 750	14' - 20'	9262	(*)	9262	(*)
INTEGRA 750S	14' - 16'	9262	(*)	9262	(*)
MSX125	14' - 20'	9274	(*)		
NC700S/X	12' - 13'	9262	(*)		
NC750S/X	14' - 20'	9262	(*)		
NT700V DEAUVILLE	06' - 12'	9262	(*)		
VFR800	02' - 05'	9262	(*)	9262	(*)
VFR800F	14' - 20'	9262	(*)	9262	(*)
X-ADV	17' - 20'	9262	(*)	9262	(*)
KAWASAKI					
ER-6F	09' - 16'	9275	(*)		
ER-6N	09' - 16'	9275	(*)		
NINJA 125	19' - 20'	9274	(*)		
NINJA 400	18' - 20'	3547	(*)		
NINJA 650	20'	9275	(*)		
NINJA H2 SX	18' - 20'	9264	(*)		
NINJA 1000 SX	20'	9264	(*)		
VERSYS 650	09' - 20'	9275	(*)		
VERSYS 1000	15' - 20'	9264	(*)		
VULCAN S	15' - 20'	9275	(*)		
VULCAN S CAFE	17' - 20'	9275	(*)		
Z125	19' - 20'	9274	(*)		
Z400	19' - 20'	3547	(*)		
Z650	17' - 20'	9275	(*)		
Z800	13' - 16'	9275	(*)		
Z800E	13' - 16'	9275	(*)		
Z900	17' - 20'	9275	(*)		
Z900RS	18' - 20'	9264	(*)		
Z900RS CAFÉ	18' - 20'	9264	(*)		
Z1000	07' - 09'	9264	(*)		
Z1000	10' - 20'	9277	(*)		
Z1000R	17' - 20'	9277	(*)		
Z1000SX	10' - 20'	9264	(*)		
ZX-6R	00' - 04'	9264	(*)		
ZX-6R	05' - 06'	9264	(*)		
ZX-6R	07' - 16'	9264	(*)		

2021 MODELS: www.puig.tv

MODEL	YEAR	BRAKE LIQUID TANK COVER	R O A T N P V	CLUTCH LIQUID TANK COVER	R O A T N P V
ZX-6R 636	13' - 16'	9264	(*)		
ZX-6R 636	19' - 20'	9264	(*)		
ZX-9R	98' - 99'	9264	(*)		
ZX-9R	00' - 04'	9264	(*)		
ZX-10R	04' - 05'	9264	(*)		
ZX-10R	06' - 10'	9264	(*)		
ZX-10R	11' - 15'	9264	(*)		
KTM					
125 DUKE	17' - 20'	9612	(*)		
390 DUKE	17' - 20'	9612	(*)		
KYMCO					
AK 550	17' - 20'	9499	(*)	9540	(*)
SUZUKI					
BURGMAN 400	17' - 20'	9274	(*)	9274	(*)
DL250 V-STROM	17' - 20'	9270	(*)		
DL650 V-STROM	04' - 10'	9270	(*)		
DL650 V-STROM	11'	9270	(*)		
DL650 V-STROM	12' - 20'	9270	(*)		
DL650XT V-STROM	15' - 20'	9270	(*)		
DL1000 V-STROM	17' - 20'	9270	(*)		
DL1000XT V-STROM	17' - 20'	9270	(*)		
DL1050 V-STROM	20'	9270	(*)	9270	(*)
DL1050XT V-STROM	20'	9270	(*)	9270	(*)
GSR750	11' - 16'	9270	(*)		
GSX-S125	17' - 20'	9612	(*)		
GSX-R125	17' - 20'	9612	(*)		
GSX-R250	17' - 20'	9270	(*)		
GSX-R600	96' - 03	9270	(*)		
GSX-R600	04' - 16	9264	(*)		
GSX-R750	96' - 03'	9270	(*)		
GSX-R750	04' - 16'	9264	(*)		
GSX-R1000	01' - 04'	9270	(*)		
GSX-R1000	05' - 16'	9264	(*)		
GSX-R1000/R	17' - 20'	9264	(*)		
GSX-S750	17' - 20'	9270	(*)		
INAZUMA	13' - 17'	9270	(*)		
KATANA	19' - 20'	3648	(*)		
SFV650 GLADIUS	09' - 15'	9270	(*)		

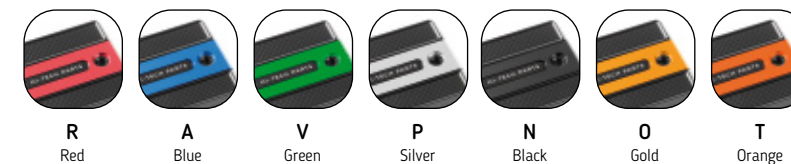



R Red A Blue V Green P Silver N Black O Gold T Orange

(*) Check price with your distributor.
 (#) BMW R NINE T with production code 0A6, 0A16
 (&) BMW R NINE T with production code 0J01, 0J03
IMPORTANT: Indicate code color after part#. Example 0973A



BRAKE-CLUTCH LIQUID TANK COVER

HI-TECH PARTS

2021 MODELS: www.puig.tv

MODEL	YEAR	BRAKE LIQUID TANK COVER		CLUTCH LIQUID TANK COVER	
SV650	99' - 04'	9270	(*)		
SV650	05'	9270	(*)		
SV650	06' - 08'	9270	(*)		
SV650S	99' - 04'	9270	(*)		
SV650S	05'	9270	(*)		
SV650S	06' - 08'	9270	(*)		
SV650	16' - 20'	9270	(*)		
SV650X	18' - 20'	9264	(*)		
TRIUMPH					
DAYTONA 675	06' - 12'	9264	(*)		
DAYTONA 675	13' - 17'	9264	(*)		
SPEED TRIPLE	08' - 10'	9264	(*)		
STREET TRIPLE R	09' - 16'	9264	(*)		
YAMAHA					
FZ1	06' - 15'	9267	(*)		
FZ1 FAZER	06' - 15'	9267	(*)		
FZ6	04' - 06'	9267	(*)		
FZ6 FAZER	07' - 08'	9267	(*)		
FZ8	10' - 16'	9267	(*)		
MT-07	14' - 20'	9267	(*)		
MT-07 TRACER	16' - 20'	9267	(*)		
MT-07 TRACER GT	19'	9267	(*)		
MT-09	13' - 16'	9267	(*)		
MT-09	17' - 20'	9267	(*)		
MT-09 SP	18' - 20'	9267	(*)		
MT-09 TRACER	15' - 20'	9267	(*)		
MT-09 TRACER GT	18' - 20'	9267	(*)		
MT-10	16' - 20'	9267	(*)		
MT-10 SP	17' - 20'	9267	(*)		
NIKEN	18' - 20'	9267	(*)		
TENERE 700	19' - 20'	9267	(*)		
T-MAX 500	08' - 11'	9269	(*)	9269	(*)
T-MAX 530	12' - 14'	9269	(*)	9269	(*)
T-MAX 530	15' - 16'	9269	(*)	9269	(*)
T-MAX 530/DX/SX	17' - 19'	9269	(*)	9269	(*)
T-MAX 560 /SX/DX/MAX TECH	20'	9269	(*)	9269	(*)
XJ6	09' - 16'	9267	(*)		
XJ6 DIVERSION	09' - 16'	9267	(*)		
XJ6 DIVERSION F	10' - 16'	9267	(*)		
XSR700	16' - 20'	9267	(*)		
XSR700 XTRIBUTE	19' - 20'	9267	(*)		

2021 MODELS: www.puig.tv

MODEL	YEAR	BRAKE LIQUID TANK COVER		CLUTCH LIQUID TANK COVER	
XSR900	16' - 20'	9267	(*)		
XT660Z TÉNÉRÉ	08' - 16'	9267	(*)		
XT1200Z SUPER TÉNÉRÉ	18' - 20'	9267	(*)		
YZF-R1	04' - 16'	9264	(*)		
YZF-R1	20'	9264	(*)		
YZF-R1M	20'	9264	(*)		
YZF-R6	06' - 20'	9264	(*)		



(*) Check price with your distributor.
 (#) BMW R NINE T with production code 0A6, 0A16
 (&) BMW R NINE T with production code 0J01, 0J03
IMPORTANT: Indicate code color after part#. Example 0973A

PARKING BRAKE LEVER
HI-TECH PARTS | TECHNICAL SECTION



REF. 85000



LOOK
Improves the looks of the bike adding a touch of exclusivity.

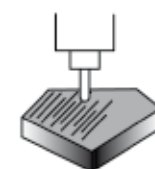

MACHINED
Machined from billet aluminium and anodized in colors.



MODEL	YEAR	REF.	A N O R P
KYMCO			
AK550	17' - 20'	9544	(*)
YAMAHA			
T-MAX 530	12' - 16'	8500	(*)
T-MAX 530/DX/SX	17' - 19'	8500	(*)
T-MAX 560 /SX/DX/MAX TECH	20'	8500	(*)

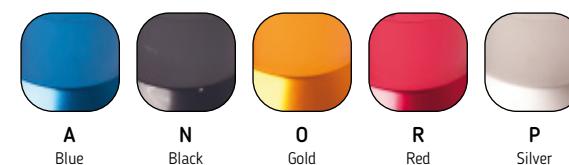

(*) Check price with your distributor.
IMPORTANT: Indicate code color after part#. Example 0973A

VINTAGE GRIPS

HI-TECH PARTS | TECHNICAL SECTION

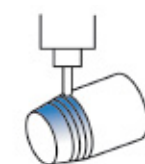
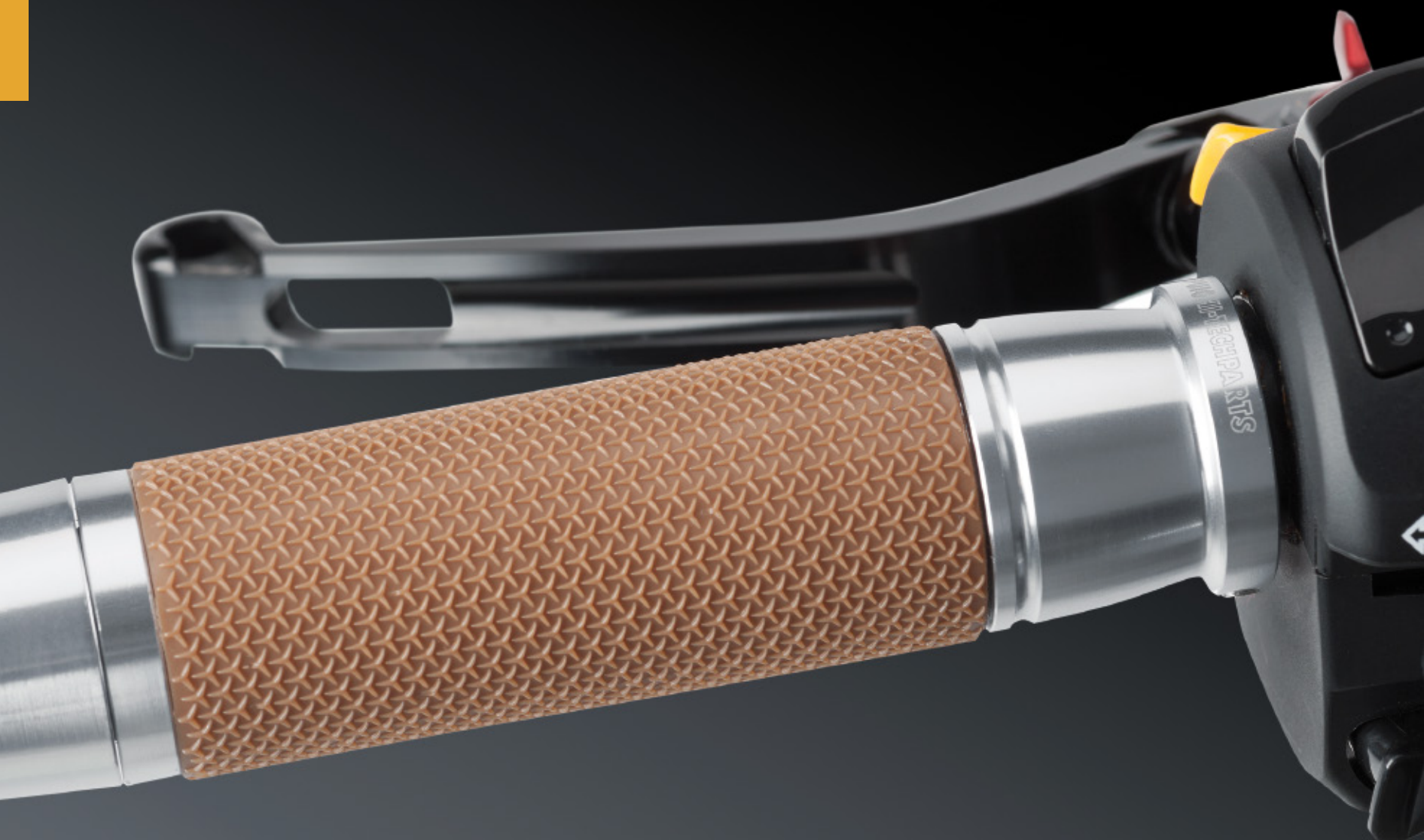

MATERIAL
Manufactured from billet aluminium.



HANDLEBAR
Suitable for diameter 22 mm.



RUBBER
Non-skid texture.
Pleasant compound.



WEIGHT
94 grams.



THROTTLE ADAPTORS
Included.

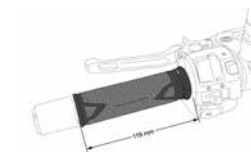

DIMENSIONS
Long 119 mm.



N
Black

P
Silver



REF. 9190N

MODEL	DIMENSIONS	REF.	N P
VINTAGE GRIPS BY PAIR	119 mm.	9190	(*)

* NOT SUITABLE WITH THE ELECTRONIC SYSTEM RIDE BY WIRE.

* NOT SUITABLE WITH OEM HEATED GRIPS.

* NOT SUITABLE FOR BIKES WHERE THE GRIPS CANNOT BE SEPARATED FROM THE GAS CANE.

Check availability for motorcycle models at www.puig.tv typing in the searching window



ASCENT GRIPS

HI-TECH PARTS | TECHNICAL SECTION

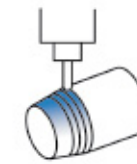

MATERIAL
Manufactured from billet aluminium.



HANDLEBAR
Suitable for diameter 22 mm.



RUBBER
Non-skid texture.
Pleasant compound.



WEIGHT
94 grams.



THROTTLE ADAPTORS
Included.

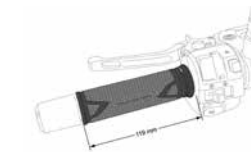

DIMENSIONS
Long 119 mm.



R Red **A** Blue **N** Black **V** Green



P Silver **O** Gold **T** Orange



REF. 6326A

MODEL	DIMENSIONS	REF.	R	O	A	T	N	P	V
ASCENT GRIPS BY PAIR	119 mm.	6326							
ASCENT GRIPS BY PAIR	123 mm.	3553							

* NOT SUITABLE WITH THE ELECTRONIC SYSTEM RIDE BY WIRE.

* NOT SUITABLE WITH OEM HEATED GRIPS.

* NOT SUITABLE FOR BIKES WHERE THE GRIPS CANNOT BE SEPARATED FROM THE GAS CANE.

Check availability for motorcycle models at www.puig.tv typing in the searching window



RADIKAL GRIPS

HI-TECH PARTS | TECHNICAL SECTION

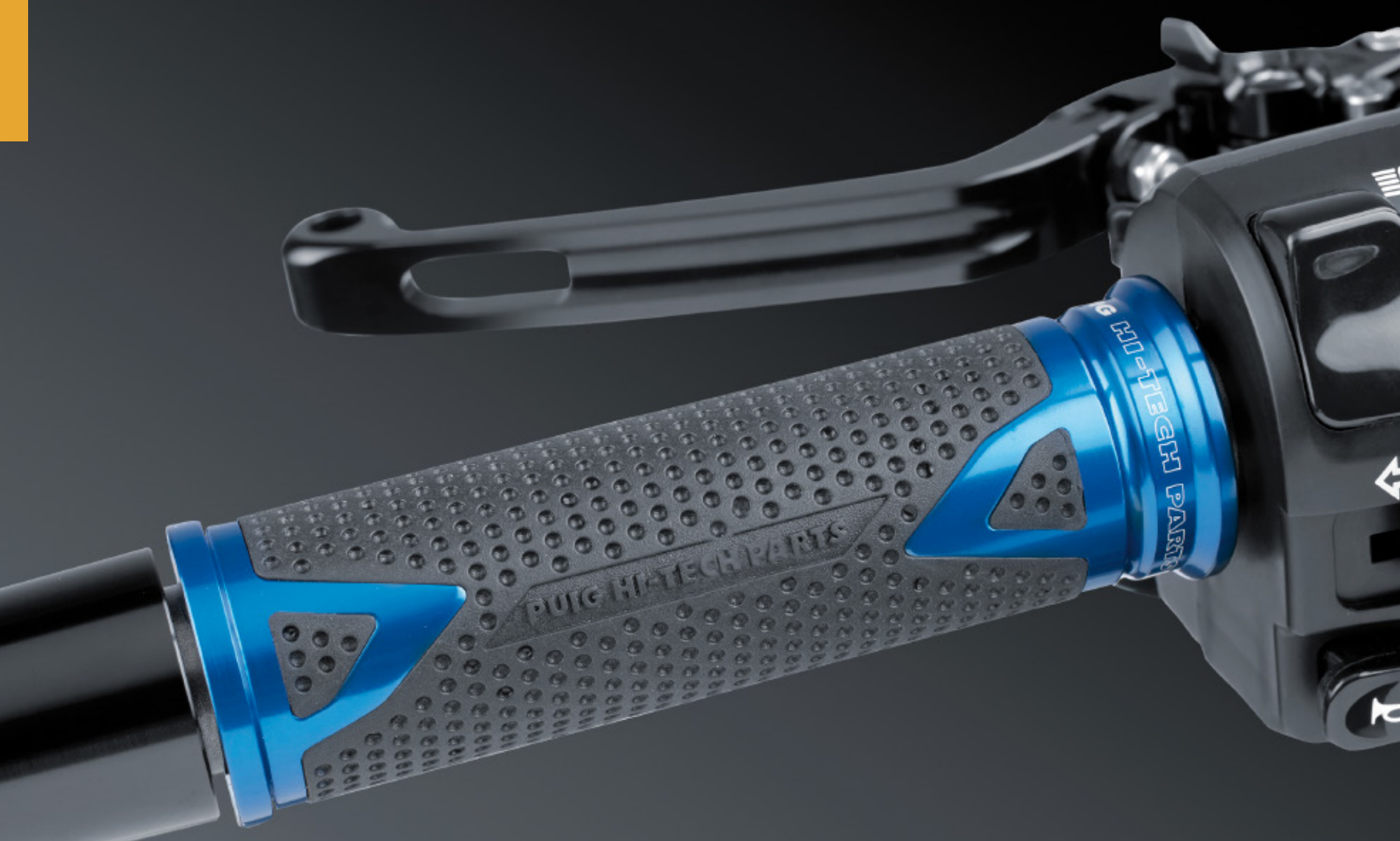

HANDLEBAR
Suitable for diameter 22 mm.



RUBBER
Non-skid texture.
Pleasant compound.



WEIGHT
64 grams.

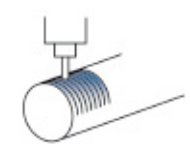

DETAIL
Aluminium anodized
insertion in different
colors.

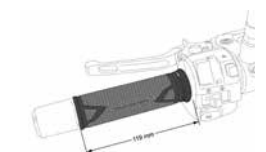

DIMENSIONS
Long 119 mm.

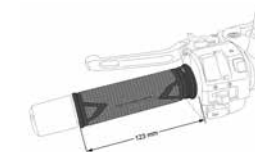

DIMENSIONS
Long 123 mm.



O Gold **V** Green **C** Carbon look **T** Orange



R Red **A** Blue **N** Black **P** Silver



REF. 63250

MODEL	DIMENSIONS	REF.	R	O	A	T	N	P	V	C
RADIKAL GRIPS BY PAIR	119 mm.	6325								
RADIKAL GRIPS BY PAIR	123 mm.	8191								

* NOT SUITABLE WITH THE ELECTRONIC SYSTEM RIDE BY WIRE.
* NOT SUITABLE WITH OEM HEATED GRIPS.
* NOT SUITABLE FOR BIKES WHERE THE GRIPS CANNOT BE SEPARATED FROM THE GAS CANE.

IMPORTANT: Due to the wide variety of original grips, some motorcycles may need to lower the edges of the gas throttle and the use of glue (such as Fischer MS Express) for a correct fixation.
In motorcycle models where it is not possible to separate the rubber grip from the gas cane because they are one piece, it is not possible to install the grips.

Check availability for motorcycle models at www.puig.tv typing in the searching window



RACING GRIPS

HI-TECH PARTS | TECHNICAL SECTION



HANDLEBAR

Suitable for diameter 22 mm.



RUBBER

Non-skid texture.
Pleasant compound.



WEIGHT

68 grams.

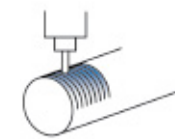

DETAIL

Aluminium anodized
insertion in different
colors.

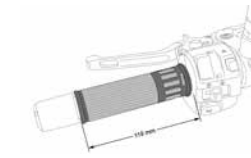

DIMENSIONS

Long 119 mm.

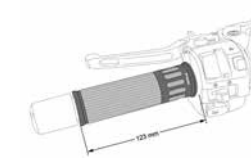

DIMENSIONS

Long 123 mm.



O Gold **V** Green **C** Carbon look **T** Orange



R Red **A** Blue **N** Black **P** Silver



REF. 5879A

MODEL	DIMENSIONS	REF.	R	O	A	T	N	P	V	C
RACING GRIPS BY PAIR	119 mm.	5879								
RACING GRIPS BY PAIR	123 mm.	8188								

* NOT SUITABLE WITH THE ELECTRONIC SYSTEM RIDE BY WIRE.

* NOT SUITABLE WITH OEM HEATED GRIPS.

* NOT SUITABLE FOR BIKES WHERE THE GRIPS CANNOT BE SEPARATED FROM THE GAS CANE.

IMPORTANT: Due to the wide variety of original grips, some motorcycles may need to lower the edges of the gas throttle and the use of glue (such as Fischer MS Express) for a correct fixation.

In motorcycle models where it is not possible to separate the rubber grip from the gas cane because they are one piece, it is not possible to install the grips.

Check availability for motorcycle models at www.puig.tv typing in the searching window



BASIC GRIPS

HI-TECH PARTS | TECHNICAL SECTION

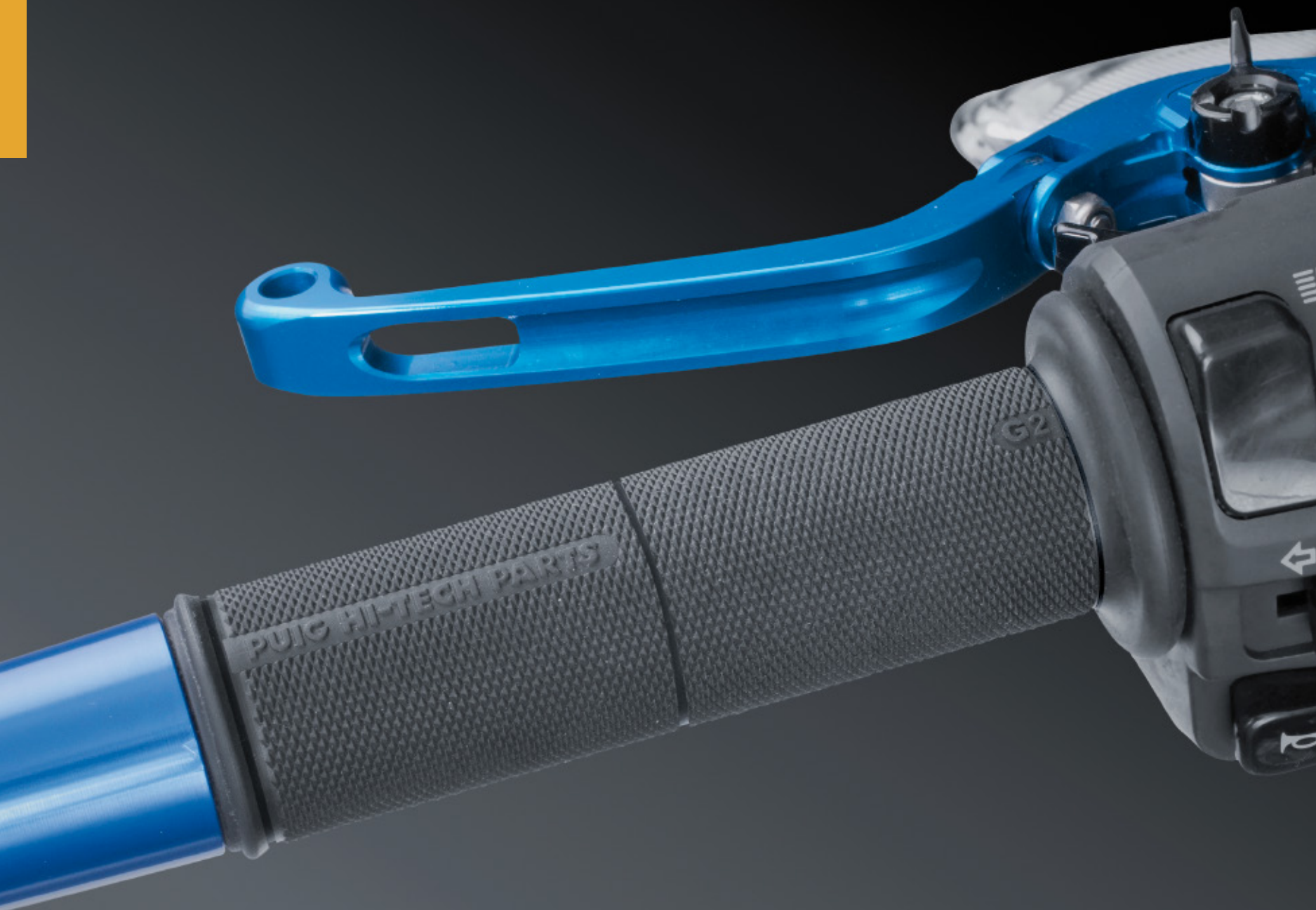

HANDLEBAR

Suitable for diameter 22 mm.



RUBBER

Non-skid texture.
Pleasant compound.

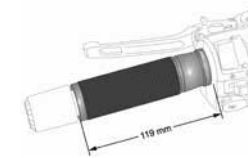

DIMENSIONS

Long 119 mm.



N
Black



REF. 6405N

MODEL	TOUCH	REF.	N
GRIPS OPENED END BY PAIR	SOFT	6404N	(*)
GRIPS OPENED END BY PAIR	MEDIUM	6405N	(*)
GRIPS OPENED END BY PAIR	HARD	6406N	(*)

* NOT SUITABLE WITH THE ELECTRONIC SYSTEM RIDE BY WIRE.

* NOT SUITABLE WITH OEM HEATED GRIPS.

* NOT SUITABLE FOR BIKES WHERE THE GRIPS CANNOT BE SEPARATED FROM THE GAS CANE.

IMPORTANT: Due to the wide variety of original grips, some motorcycles may need to lower the edges of the gas throttle and the use of glue (such as Fischer MS Express) for a correct fixation.

In motorcycle models where it is not possible to separate the rubber grip from the gas cane because they are one piece, it is not possible to install the grips.

Check availability for motorcycle models at www.puig.tv typing in the searching window

BASIC

BAR ENDS THRUSTER MODEL

HI-TECH PARTS | TECHNICAL SECTION



REF. 9420

The black sections and the end caps are sold separately.



REF. 9411N + 9420V

THRUSTER MODEL	REF.	R	O	A	T	N
		N	P	V		
BLACK SECTION BY PAIR THRUSTER MODEL	SEE WEB					
UNIVERSAL BLACK SECTION BY PAIR FOR HANDLEBARS DIAMETERS BETWEEN 13-18 mm.	9411					(*)
END CAPS BY PAIR	9420	(*)				(*)
BLACK SECTION BY PAIR FOR PUIG HANDLEBAR WITH INTERIOR THREAD	9594					(*)



SPARES	REF.	N
WELLNUT M10 BY PAIR	6815N	(*)
WELLNUT M15 BY PAIR	6816N	(*)
WELLNUT M17 BY PAIR	6817N	(*)



R Red A Blue V Green N Black



P Silver O Gold T Orange

(*) Check price with your distributor.

IMPORTANT: Indicate code color after part#. Example 0973A

Check availability for motorcycle models at www.puig.tv typing in the searching window

BAR ENDS LONG AND SHORT MODELS

HI-TECH PARTS | TECHNICAL SECTION



REF. 5777N



REF. 6203N

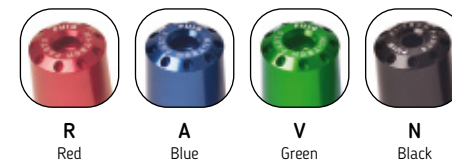

R Red A Blue V Green N Black

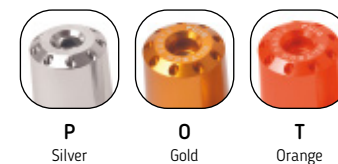

P Silver O Gold T Orange

LONG MODEL	REF.		
BAR ENDS BY PAIR LONG MODEL	SEE WEB		
UNIVERSAL BAR ENDS BY PAIR FOR HANDLEBAR DIAMETERS BETWEEN 13-18 mm.	5777	(*)	
BAR ENDS BY PAIR FOR PUIG HANDLEBAR WITH INTERIOR THREAD	7425	(*)	



SHORT MODEL	REF.		
BAR ENDS BY PAIR SHORT MODEL	SEE WEB		
UNIVERSAL BAR ENDS BY PAIR FOR HANDLEBAR DIAMETERS BETWEEN 13-18 mm.	6203	(*)	
BAR ENDS BY PAIR FOR PUIG HANDLEBAR WITH INTERIOR THREAD	7424	(*)	



SPARES	REF.	PRICE
WELLNUT M10 BY PAIR	6815N	(*)
WELLNUT M15 BY PAIR	6816N	(*)
WELLNUT M17 BY PAIR	6817N	(*)

(*) Check price with your distributor.

IMPORTANT: Indicate code color after part#. Example 0973A

Check availability for motorcycle models at www.puig.tv typing in the searching window

BAR ENDS SHORT WITH RING AND RACE MODELS

HI-TECH PARTS | TECHNICAL SECTION



REF. 8498N

SHORT WITH RING MODEL	REF.	N
BAR ENDS BY PAIR SHORT WITH RING MODELS	SEE WEB	
UNIVERSAL BAR ENDS BY PAIR FOR HANDLEBAR DIAMETERS BETWEEN 13-18 mm.	8498	(*)
BAR ENDS BY PAIR FOR PUIG HANDLEBAR WITH INTERIOR THREAD	8334	(*)
SPARES		
RINGS BY PAIR	9170	(*)



The set includes 12 rings (2 each color): blue, orange, black, gold, silver and red.

Green rings only for Kawasaki and Universal models.



REF. 62220

RACE MODEL	REF.	R O A T N P V
UNIVERSAL BAR ENDS BY PAIR FOR HANDLEBAR DIAMETERS BETWEEN 13-18 mm.	6222	(*)

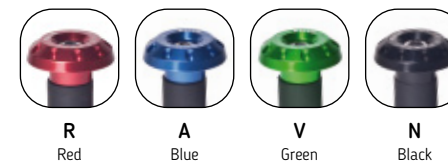

SPARES	REF.	PRICE
WELLNUT M10 BY PAIR	6815N	(*)
WELLNUT M15 BY PAIR	6816N	(*)
WELLNUT M17 BY PAIR	6817N	(*)

(*) Check price with your distributor.

IMPORTANT: Indicate code color after part#. Example 0973A

Check availability for motorcycle models at www.puig.tv typing in the searching window

BAR ENDS

REARVIEW MIRROR LOOK

HI-TECH PARTS | TECHNICAL SECTION



ANTI-GLARE GLASS

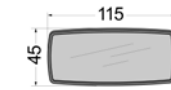

NOT HOMOLOGATED
Ø 58 mm.



DIMENSIONS



ADJUSTABLE
Inclination and height.

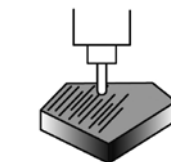

MATERIAL
Manufactured from billet aluminium and anodized.



ADAPTABLE
Specific available adapters for bike model.

For handlebars with inner diameter of 13/18 mm.

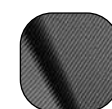

N
Black

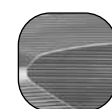

D
Aluminium Anodized



REF. 3764D

MODEL	SIDE	REF.	N D
UNIVERSAL	RIGHT	3764	(*)
UNIVERSAL	LEFT	3764	(*)

(*) Check price with your distributor.

IMPORTANT: Indicate code color after part#. Example 0973A

Check availability for motorcycle models at www.puig.tv typing in the searching window

LOOK

REARVIEW MIRROR GRAND TRACKER

HI-TECH PARTS | TECHNICAL SECTION



**ANTI GLARE
GLASS**

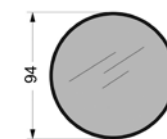

HOMOLOGATED
Ø 94 mm.

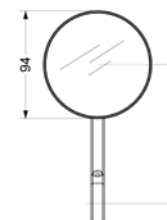

DIMENSIONS



ADJUSTABLE
Inclination and height.



ADAPTABLE
Specific available adapters for bike model.

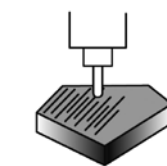

MATERIAL
Manufactured from billet aluminium and anodized.

For handlebars with inner diameter of 13/18 mm.

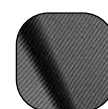

N
Black

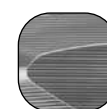

D
Aluminium Anodized



MODEL	SIDE	REF.	N D
UNIVERSAL	RIGHT	9691	(*)
UNIVERSAL	LEFT	9691	(*)

(*) Check price with your distributor.

IMPORTANT: Indicate code color after part#. Example 0973A

Check availability for motorcycle models at www.puig.tv typing in the searching window

GRAND TRACKER

REARVIEW MIRROR TRACKER

HI-TECH PARTS | TECHNICAL SECTION



**ANTI GLARE
GLASS**

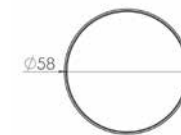

NOT HOMOLOGATED
Ø 58 mm.

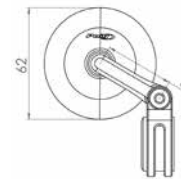

ADJUSTABLE
Inclination and height.



ADAPTABLE
To handlebar bar end.

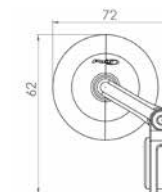

MATERIAL
Manufactured from
billet aluminium and
anodized.

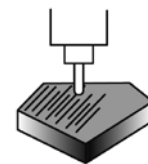

ADAPTABLE
Specific available
adapters for bike model.

For handlebars with inner diameter of 13/18 mm.

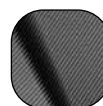

N
Black

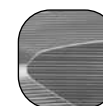

D
Aluminium Anodized



REF. 9506D

MODEL	SIDE	REF.	N D
UNIVERSAL	RIGHT	9506	(*)
UNIVERSAL	LEFT	9506	(*)

(*) Check price with your distributor.

IMPORTANT: Indicate code color after part#. Example 0973A

Check availability for motorcycle models at www.puig.tv typing in the searching window



REARVIEW MIRROR HI-TECH IV

HI-TECH PARTS | TECHNICAL SECTION



ANTI-GLARE GLASS

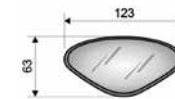

NOT HOMOLOGATED

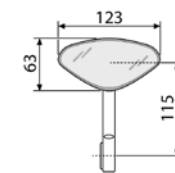

DIMENSIONS



ADJUSTABLE
Inclination and height.



ADAPTABLE
Specific available adapters for bike model.

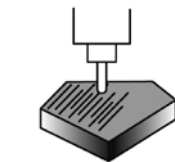

MATERIAL
Manufactured from billet aluminium and anodized.

For handlebars with inner diameter of 13/18 mm.

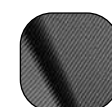

N
Black

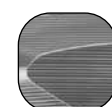

D
Aluminium Anodized



MODEL	SIDE	REF.	N D
UNIVERSAL	RIGHT	6994	(*)
UNIVERSAL	LEFT	6994	(*)

(*) Check price with your distributor.

IMPORTANT: Indicate code color after part#. Example 0973A

Check availability for motorcycle models at www.pulg.tv typing in the searching window



REARVIEW MIRROR MP

HI-TECH PARTS | TECHNICAL SECTION

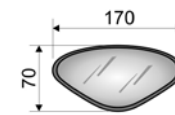

NOT HOMOLOGATED

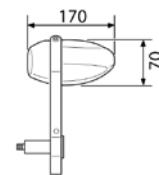

DIMENSIONS



ADAPTABLE

Specific available adapters for bike model.

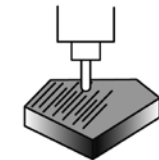

MATERIAL

Manufactured from billet aluminium and anodized.



For handlebars with inner diameter of 13/18 mm.

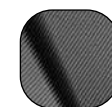

N
Black

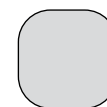

P
Silver



REF. 5220N

MODEL	SIDE	REF.	N	P
UNIVERSAL	RIGHT	5220	(*)	(*)
UNIVERSAL	LEFT	5220	(*)	(*)

(*) Check price with your distributor.

IMPORTANT: Indicate code color after part#. Example 0973A

Check availability for motorcycle models at www.puig.tv typing in the searching window

REARVIEW MIRROR MONACO

HI-TECH PARTS | TECHNICAL SECTION



**ANTI GLARE
GLASS**

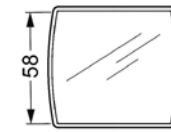

NOT HOMOLOGATED
Ø 58 mm.

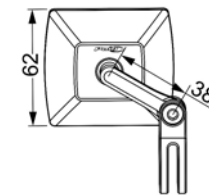

ADJUSTABLE
Inclination and height.

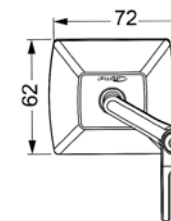
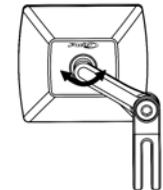

ADAPTABLE
To handlebar bar end.

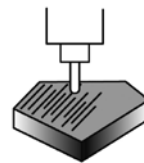

MATERIAL
Manufactured from
billet aluminium and
anodized.



ADAPTABLE
Specific available
adapters for bike model.

For handlebars with inner diameter of 13/18 mm.

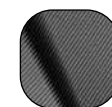

N
Black

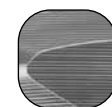

D
Aluminium Anodized



REF. 3668D

MODEL	SIDE	REF.	N D
UNIVERSAL	RIGHT	3668	(*)
UNIVERSAL	LEFT	3668	(*)

(*) Check price with your distributor.

IMPORTANT: Indicate code color after part#. Example 0973A

Check availability for motorcycle models at www.puig.tv typing in the searching window



REARVIEW MIRROR RETRO

HI-TECH PARTS | TECHNICAL SECTION

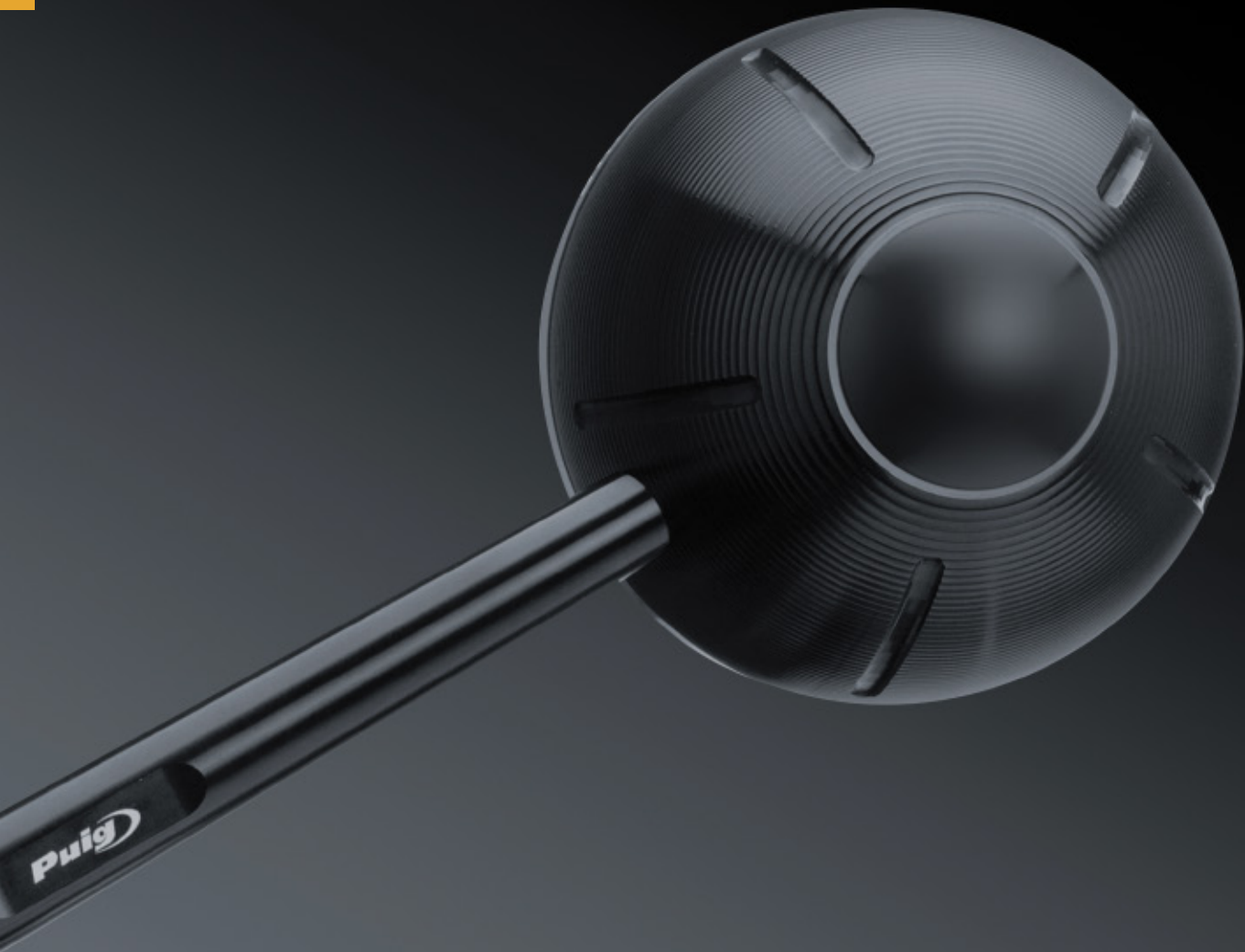

**ANTI GLARE
GLASS**

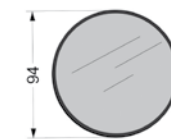

HOMOLOGATED
Ø 94 mm.

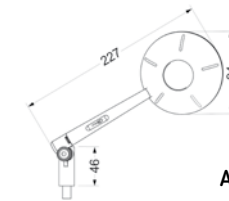

ADJUSTABLE
Inclination and height.

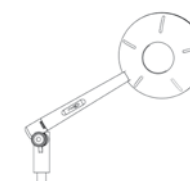
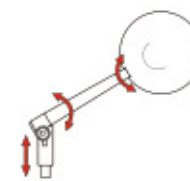

ADAPTABLE
To the handlebar and
adapters available for
the original fairing.

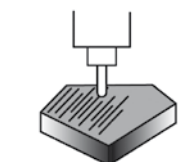

MATERIAL
Manufactured from
billet aluminium and
anodized.

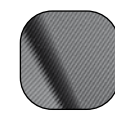
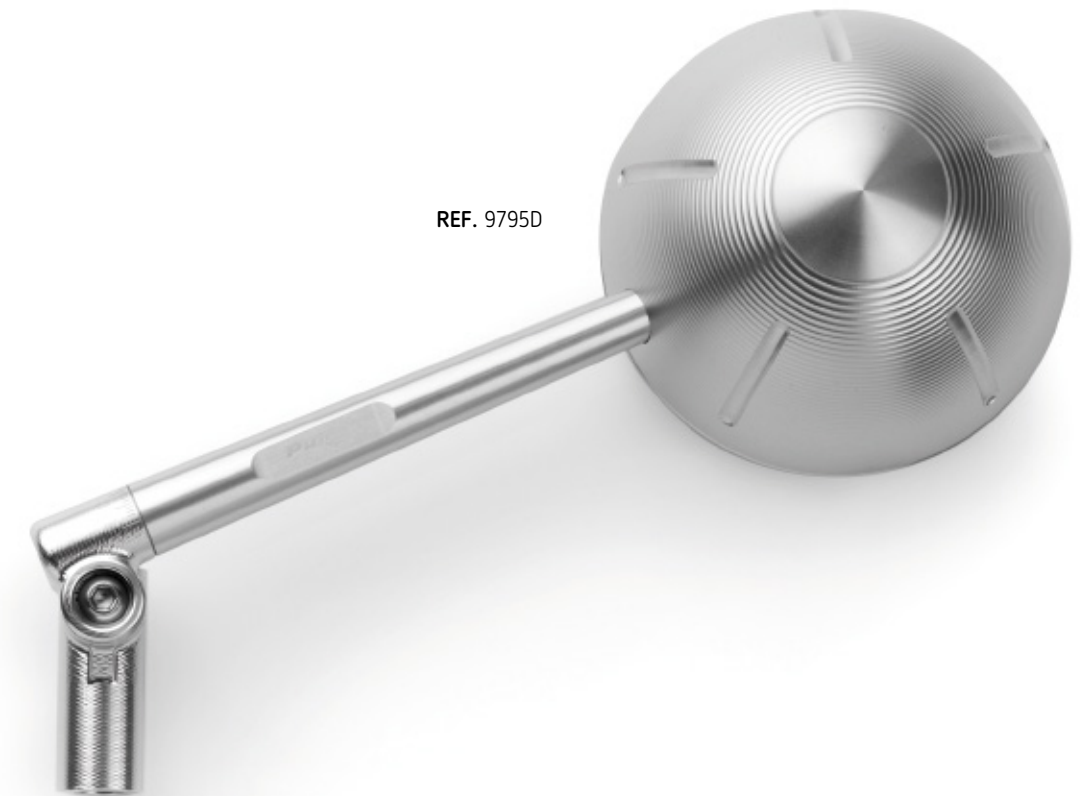

N
Black

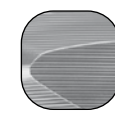

D
Aluminium Anodized

MODEL	SIDE	REF.	N	D
UNIVERSAL THREAD M10/125	RIGHT	9794 (#)	(*)	
UNIVERSAL THREAD M10/125	LEFT	9795	(*)	

(#) ADAPTOR KIT INCLUDED: 2 M10 / 125 SCREWS + 1 M10 / 125 LEFT THREAD SCREW.

(*) Check price with your distributor.

Check availability for motorcycle models at www.puig.tv typing in the searching window

[BACK MIRROR RETRO](#) 🔍

REARVIEW MIRROR HYPERNAKED

HI-TECH PARTS | TECHNICAL SECTION



**ANTI GLARE
GLASS**



NOT HOMOLOGATED
145 x 48 mm.

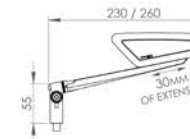

ADJUSTABLE
Inclination, adjustment,
and extension of the
mirror.

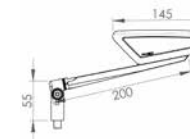
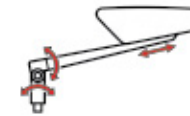

ADAPTABLE
Available adapters for
handlebar and fairing
fitting.

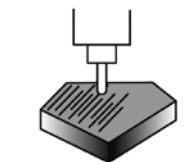

MATERIAL
Manufactured from
billet aluminium and
anodized.



REF. 9884D

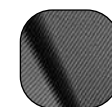

N
Black

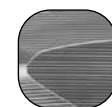

D
Aluminium Anodized

MODEL	SIDE	REF.	N	D
UNIVERSAL THREAD M10/125	RIGHT	9883 (#)	(*)	
UNIVERSAL THREAD M10/125	LEFT	9884	(*)	

(#) ADAPTOR KIT INCLUDED: 2 M10 / 125 SCREWS + 1 M10 / 125 LEFT THREAD SCREW.

(*) Check price with your distributor.

Check availability for motorcycle models at www.puig.tv typing in the searching window



REARVIEW MIRROR EXPLORER

HI-TECH PARTS | TECHNICAL SECTION

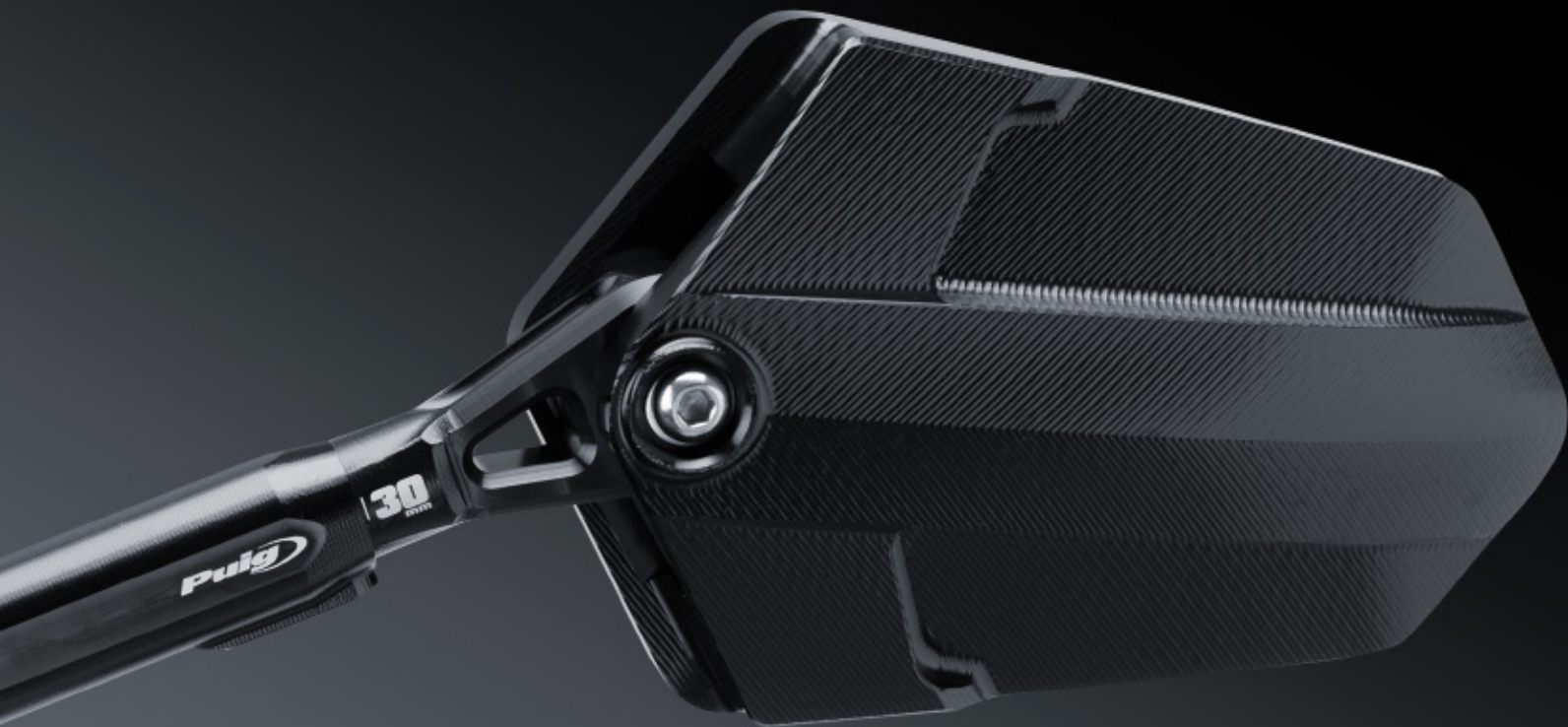

ANTI-GLARE GLASS

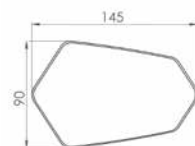

HOMOLOGATED:
145 x 90 mm.

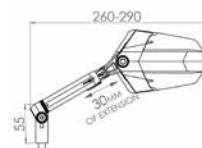

ADJUSTABLE
Inclination, adjustment, and extension of the mirror.

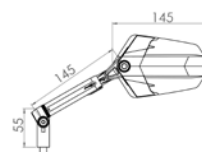
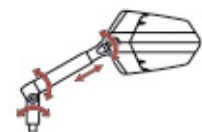

ADAPTABLE
Available adapters for handlebar and fairing fitting.

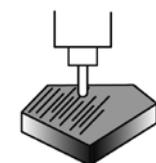

MATERIAL
Manufactured from billet aluminium and anodized.



N
Black

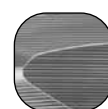

D
Aluminium Anodized



MODEL	SIDE	REF.	N	D
UNIVERSAL THREAD M10/125	RIGHT	010NN (1) (#)	(*)	
UNIVERSAL THREAD M10/125	RIGHT	010DD (2) (#)	(*)	
UNIVERSAL THREAD M10/125	RIGHT	010DN (3) (#)	(*)	
UNIVERSAL THREAD M10/125	RIGHT	010ND (4) (#)	(*)	
UNIVERSAL THREAD M10/125	LEFT	014NN (1)	(*)	
UNIVERSAL THREAD M10/125	LEFT	014DD (2)	(*)	
UNIVERSAL THREAD M10/125	LEFT	014DN (3)	(*)	
UNIVERSAL THREAD M10/125	LEFT	014ND (4)	(*)	

(#) ADAPTOR KIT INCLUDED: 2 M10 / 125 SCREWS + 1 M10 / 125 LEFT THREAD SCREW.

(*) Check price with your distributor.

Check availability for motorcycle models at www.puig.tv typing in the searching window



REARVIEW MIRROR GT.1

HI-TECH PARTS | TECHNICAL SECTION



ANTI-GLARE GLASS

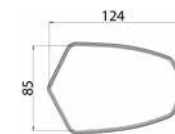

HOMOLOGATED

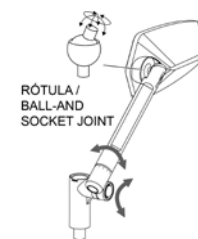

ADJUSTABLE

Inclination and height.

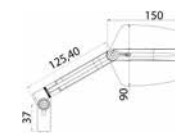

ADAPTABLE

Available adapters for handlebar and fairing fitting.

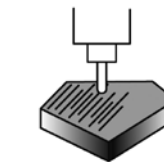

MATERIAL

Manufactured from billet aluminium and anodized.

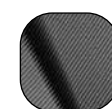

N
Black

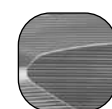

D
Aluminium Anodized

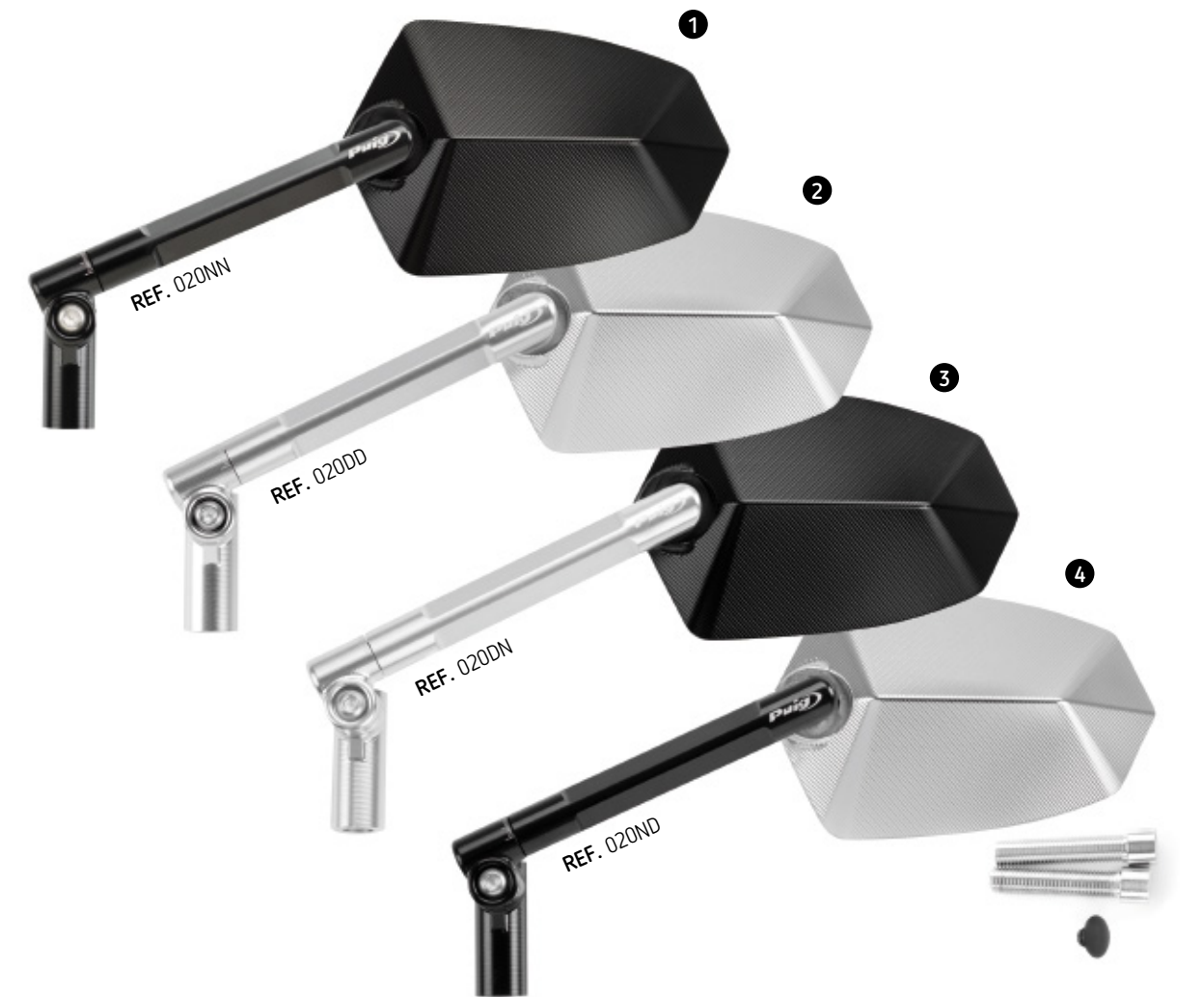

MODEL	SIDE	REF.	N	D
UNIVERSAL THREAD M10/125	RIGHT	020NN (1)	(*)	
UNIVERSAL THREAD M10/125	RIGHT	020DD (2)	(*)	
UNIVERSAL THREAD M10/125	RIGHT	020DN (3)	(*)	
UNIVERSAL THREAD M10/125	RIGHT	020ND (4)	(*)	
UNIVERSAL THREAD M10/125	LEFT	019NN (1) (#)	(*)	
UNIVERSAL THREAD M10/125	LEFT	019DD (2) (#)	(*)	
UNIVERSAL THREAD M10/125	LEFT	019DN (3) (#)	(*)	
UNIVERSAL THREAD M10/125	LEFT	019ND (4) (#)	(*)	

(#) ADAPTOR KIT INCLUDED: 2 M10 / 125 SCREWS + 1 M10 / 125 LEFT THREAD SCREW.

(*) Check price with your distributor.

Check availability for motorcycle models at www.puig.tv typing in the searching window

GT.1

REARVIEW MIRROR GTI

HI-TECH PARTS | TECHNICAL SECTION



ANTI-GLARE GLASS

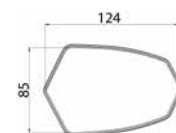

HOMOLOGATED

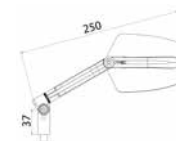

ADJUSTABLE
Inclination and height.

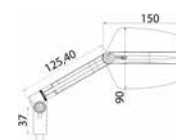
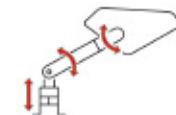

ADAPTABLE
Available adapters for handlebar and fairing fitting.

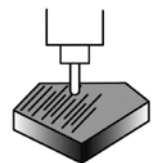

MATERIAL
Manufactured from billet aluminium and anodized.

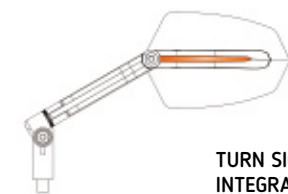

TURN SIGNAL INTEGRATED

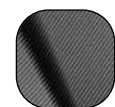

N
Black

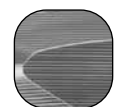

D
Aluminium Anodized

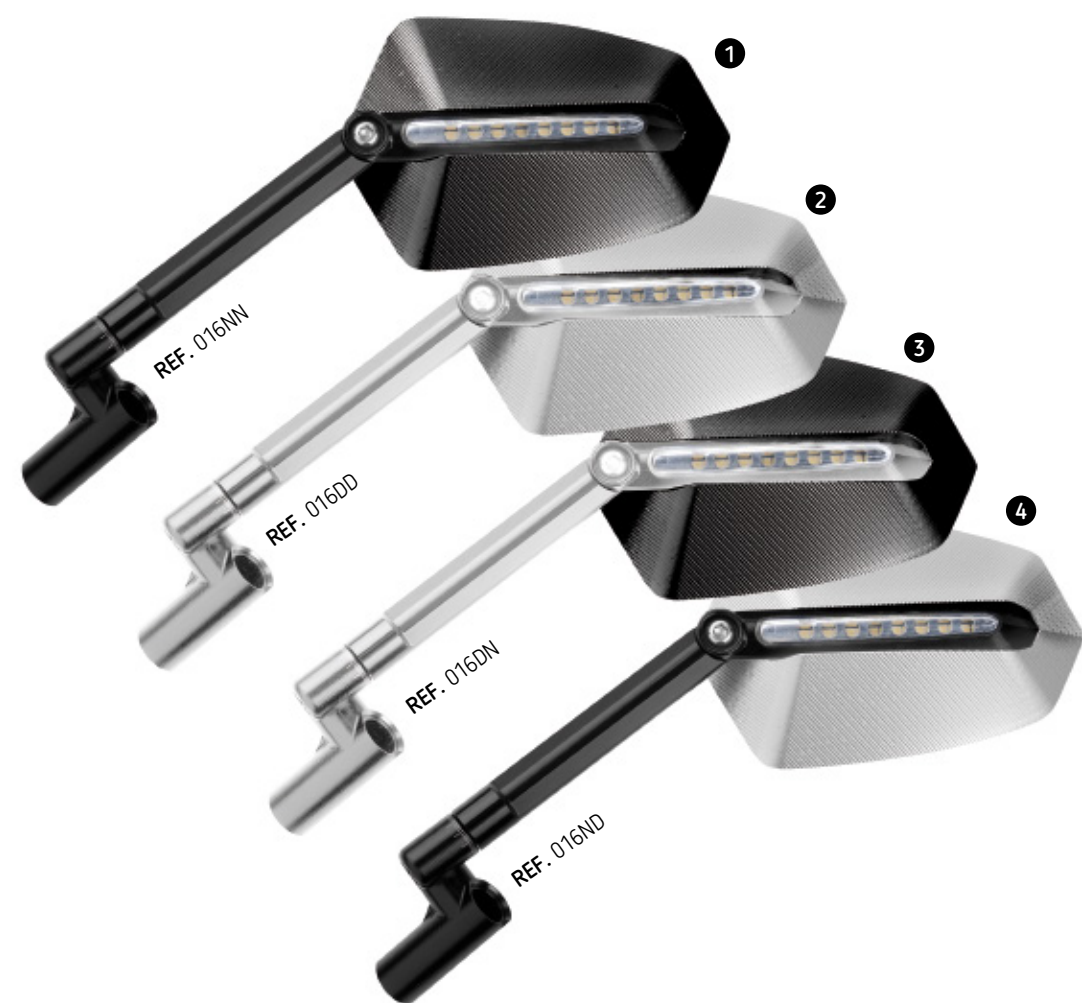

MODEL	SIDE	REF.	N	D
UNIVERSAL THREAD M10/125	RIGHT	015NN (1) (#)	(*)	
UNIVERSAL THREAD M10/125	RIGHT	015DD (2) (#)	(*)	
UNIVERSAL THREAD M10/125	RIGHT	015DN (3) (#)	(*)	
UNIVERSAL THREAD M10/125	RIGHT	015ND (4) (#)	(*)	
UNIVERSAL THREAD M10/125	LEFT	016NN (1)	(*)	
UNIVERSAL THREAD M10/125	LEFT	016DD (2)	(*)	
UNIVERSAL THREAD M10/125	LEFT	016DN (3)	(*)	
UNIVERSAL THREAD M10/125	LEFT	016ND (4)	(*)	

(#) ADAPTOR KIT INCLUDED: 2 M10 / 125 SCREWS + 1 M10 / 125 LEFT THREAD SCREW.

(*) Check price with your distributor.

Check availability for motorcycle models at www.puig.tv typing in the searching window



REARVIEW MIRROR F1.1.

HI-TECH PARTS | TECHNICAL SECTION



ANTI-GLARE GLASS

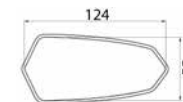

NOT HOMOLOGATED

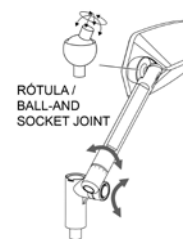

ADJUSTABLE

Inclination and height.

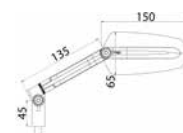

ADAPTABLE

Available adapters for handlebar and fairing fitting.

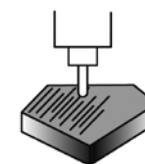

MATERIAL

Manufactured from billet aluminium and anodized.

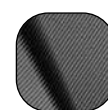

N
Black

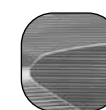

D
Aluminium Anodized

MODEL	SIDE	REF.	N	D
UNIVERSAL THREAD M10/125	RIGHT	017NN (1) (#)	(*)	
UNIVERSAL THREAD M10/125	RIGHT	017DD (2) (#)	(*)	
UNIVERSAL THREAD M10/125	RIGHT	017DN (3) (#)	(*)	
UNIVERSAL THREAD M10/125	RIGHT	017ND (4) (#)	(*)	
UNIVERSAL THREAD M10/125	LEFT	018NN (1)	(*)	
UNIVERSAL THREAD M10/125	LEFT	018DD (2)	(*)	
UNIVERSAL THREAD M10/125	LEFT	018DN (3)	(*)	
UNIVERSAL THREAD M10/125	LEFT	018ND (4)	(*)	

(#) ADAPTOR KIT INCLUDED: 2 M10 / 125 SCREWS + 1 M10 / 125 LEFT THREAD SCREW.

(*) Check price with your distributor.

Check availability for motorcycle models at www.puig.tv typing in the searching window



// REARVIEW MIRROR RS1

MODEL	SIDE	REF.	N	C
(1) UNIVERSAL WITH BAR	RIGHT	7340 (#)	(*)	
(1) UNIVERSAL WITH BAR	LEFT	7341 (#)	(*)	
(2) UNIVERSAL 30° FAIRING FITTING	RIGHT	7342	(*)	
(2) UNIVERSAL 30° FAIRING FITTING	LEFT	7343	(*)	
(3) UNIVERSAL FAIRING FITTING	RIGHT	7344	(*)	
(3) UNIVERSAL FAIRING FITTING	LEFT	7345	(*)	
(4) UNIVERSAL 70° FAIRING FITTING	RIGHT	7346	(*)	
(4) UNIVERSAL 70° FAIRING FITTING	LEFT	7347	(*)	

(#) ADAPTOR KIT INCLUDED: M10x1,25RH, 10x1,25LH, M8x1,25RH, M8x1,25LH.
REAR MIRROR WITH PLASTIC BASE.

HOMOLOGATED

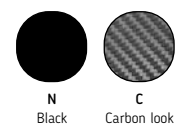

(*) Check price with your distributor.

IMPORTANT: Indicate code color after part#. Example 0973A

Check availability for motorcycle models at www.puig.tv typing in the searching window



RS1

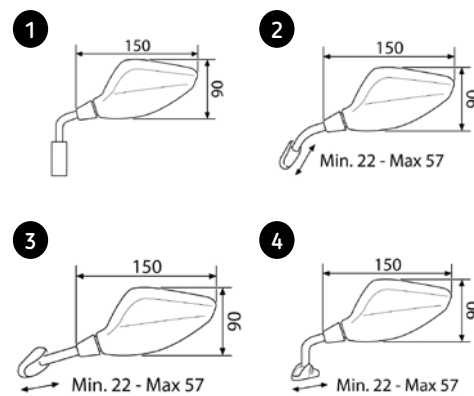

// REARVIEW MIRROR RS2

MODEL	SIDE	REF.	N	C
(1) UNIVERSAL WITH BAR	RIGHT	7348 (#)	(*)	
(1) UNIVERSAL WITH BAR	LEFT	7349 (#)	(*)	
(2) UNIVERSAL 30° FAIRING FITTING	RIGHT	7350	(*)	
(2) UNIVERSAL 30° FAIRING FITTING	LEFT	7351	(*)	
(3) UNIVERSAL FAIRING FITTING	RIGHT	7352	(*)	
(3) UNIVERSAL FAIRING FITTING	LEFT	7353	(*)	
(4) UNIVERSAL 70° FAIRING FITTING	RIGHT	7354	(*)	
(4) UNIVERSAL 70° FAIRING FITTING	LEFT	7355	(*)	

(#) ADAPTOR KIT INCLUDED: M10x1,25RH, 10x1,25LH, M8x1,25RH, M8x1,25LH.
REAR MIRROR WITH PLASTIC BASE.

NOT HOMOLOGATED

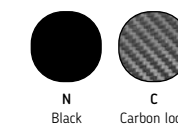

(*) Check price with your distributor.

IMPORTANT: Indicate code color after part#. Example 0973A

Check availability for motorcycle models at www.puig.tv typing in the searching window



RS2

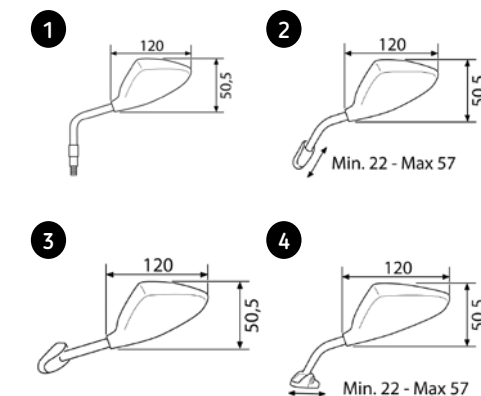



// REARVIEW MIRROR MT

MODEL	SIDE	REF.	N
UNIVERSAL THREAD M10	RIGHT	4310 (#)	(*)
UNIVERSAL THREAD M10	LEFT	4311	(*)

(#) ADAPTOR KIT INCLUDED: M10 x 1,25 (reverse thread).
REAR MIRROR WITH ALUMINIUM BASE.

(*) Check price with your distributor.

IMPORTANT: Indicate code color after part#. Example 0973A

Check availability for motorcycle models at www.puig.tv
typing in the searching window

MT

NOT HOMOLOGATED

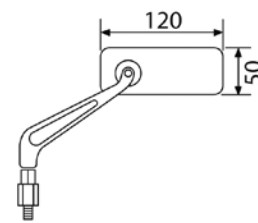
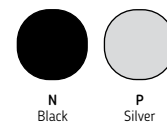

// REARVIEW MIRROR MG

MODEL	SIDE	REF.	N
UNIVERSAL THREAD M10	RIGHT	4497 (#)	(*)
UNIVERSAL THREAD M10	LEFT	4498	(*)

(#) ADAPTOR KIT INCLUDED: M10 x 1,25 (reverse thread).
REAR MIRROR WITH ALUMINIUM BASE.

(*) Check price with your distributor.

IMPORTANT: Indicate code color after part#. Example 0973A

Check availability for motorcycle models at www.puig.tv
typing in the searching window

MG

NOT HOMOLOGATED

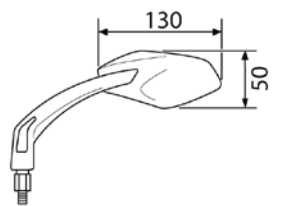



// REARVIEW MIRROR Z1

MODEL	SIDE	REF.	C
(1) UNIVERSAL THREAD M10 TO HANDLEBAR	RIGHT	4306 (#)	(*)
(1) UNIVERSAL THREAD M10 TO HANDLEBAR	LEFT	4307	(*)
(2) FAIRING FITTING	RIGHT	4251	(*)
(2) FAIRING FITTING	LEFT	4252	(*)

(#) ADAPTOR KIT INCLUDED: M10 x 1.25 (reverse thread).
REAR MIRROR WITH CARBON LOOK BASE.

(*) Check price with your distributor.

IMPORTANT: Indicate code color after part#. Example 0973A

Check availability for motorcycle models at www.puig.tv typing in the searching window

HOMOLOGATED



C
Carbon look

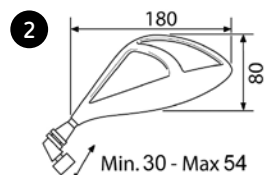
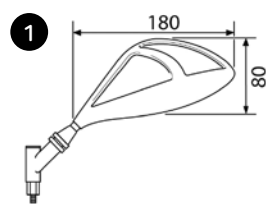

ORIGINAL REARVIEW MIRRORS LEADS, SUPPORT, FLANGE AND SHIFTER

HI-TECH PARTS

REF. 7511N



// BASE CAPS FOR OEM REAR MIRRORS BY PAIR

MODEL	YEAR	REF.	A	N	O	R
YAMAHA						
T-MAX 530	12' - 16'	7511		(*)		
T-MAX 530/DX/SX	17' - 19'	7511		(*)		
T-MAX 560 /SX/DX/MAX TECH	20'	3875		(*)		

REF. 5216N



// HANDLEBAR BASE CLAMP MIRROR 22 MM.

MODEL	REF.	N
Ø 10 RIGHT THREAD	5216N	(*)
Ø 10 LEFT THREAD	5217N	(*)

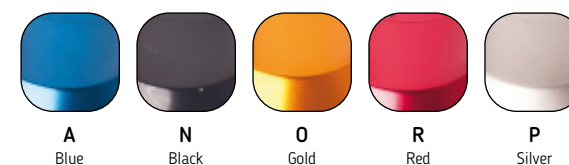

REF. 7517N

// ADAPTOR TO AXLE LEVER

MODEL	YEAR	REF.	N
YAMAHA			
T-MAX 530	12' - 16'	7517	(*)
T-MAX 530/DX/SX	17' - 19'	7517 (#)	(*)
T-MAX 560/DX/SX/TECH MAX	20'	3883	(*)

(#) FOR T-MAX 530/SX/DX 17' COMPATIBLE ONLY FOR V-TECH LINES SPORT / TOURING PUIG



REF. 5021N

// REARVIEW MIRROR MOVE SET

MODEL	REF.	N
UNIVERSAL DISPLACER MIRROR DIAMETER 10 mm. LEFT SIDE	5021N	(*)
UNIVERSAL REAR MIRROR MOVE SET DIAMETER 10 mm. RIGHT SIDE	5021N	(*)
UNIVERSAL REAR MIRROR MOVE SET DIAMETER 10 mm. RIGHT SIDE LEFT THREAD	5107N	(*)

(*) Check price with your distributor.

IMPORTANT: Indicate code color after part#. Example: 0973A.

REARVIEW MIRROR CAPS

HI-TECH PARTS | TECHNICAL SECTION



FUNCTION

Cover the fairing holes when the original rearview mirrors are taken out. Specific models for each motorbike.

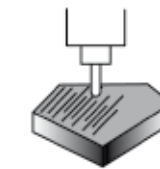

MACHINED

Machined and anodized black aluminium cap with a design that fits the motorcycle perfectly.



REF. 3845N



REF. 3847N



N
Black

MODEL	YEAR	REF.	N
DUCATI			
PANIGALE V2	20'	20427N	(*)
HONDA			
CBR500R	13' - 19'	3854N	(*)
CBR600RR	13' - 16'	3854N	(*)
CBR650F	14'-19'	3854N	(*)
CBR650R	19'	3854N	(*)
CBR1000RR FIREBLADE/SP/SP2	17' - 19'	3843N	(*)
CBR1000RR FIREBLADE/SP/SP2	17' - 19'	3843N	(*)
CBR1000RR FIREBLADE/SP	20'	3843N	(*)
KAWASAKI			
NINJA 125	19'	3859N	(*)
NINJA 250SL	15'-16'	3859N	(*)
NINJA 400	18'-19'	3859N	(*)
NINJA 650	20'	3859N	(*)
ZX-10R	16' - 19'	3847N	(*)
ZX-10R	16' - 19'	3847N	(*)
ZX-10RR	17' - 19'	3847N	(*)
ZX-10RR	17' - 19'	3847N	(*)
SUZUKI			
GSX-R125	17'-19'	3851N	(*)
GSX-R125	17'-19'	3851N	(*)
GSX-R250	17'-19'	3851N	(*)
GSX-R250	17'-19'	3851N	(*)
GSX-R1000/R	17' - 19'	3848N	(*)
GSX-R1000/R	17' - 19'	3848N	(*)
TRIUMPH			
DAYTONA 675/R	13' - 16'	3852N	(*)
DAYTONA 675/R	13' - 16'	3852N	(*)
YAMAHA			
XJ6 DIVERSION	09'-16'	3855N	(*)
YZF-R1	09'-14'	3855N	(*)
YZF-R1	15'-19'	3845N	(*)
YZF-R1	15'-20'	3845N	(*)
YZF-R1M	20'	3845N	(*)
YZF-R3	15'-19'	3856N	(*)
YZF-R6	06'-16'	3857N	(*)
YZF-R6	06'-16'	3857N	(*)
YZF-R6	17'-19'	3845N	(*)
YZF-R6	17'-19'	3845N	(*)

(*) Check price with your distributor.

IMPORTANT: Indicate code color after part#. Example 0973A.

MOTORCYCLE HANDGUARDS

HI-TECH PARTS | TECHNICAL SECTION

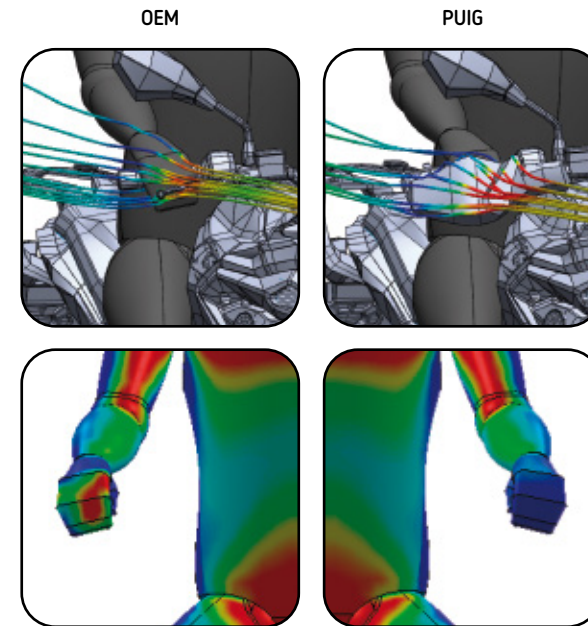
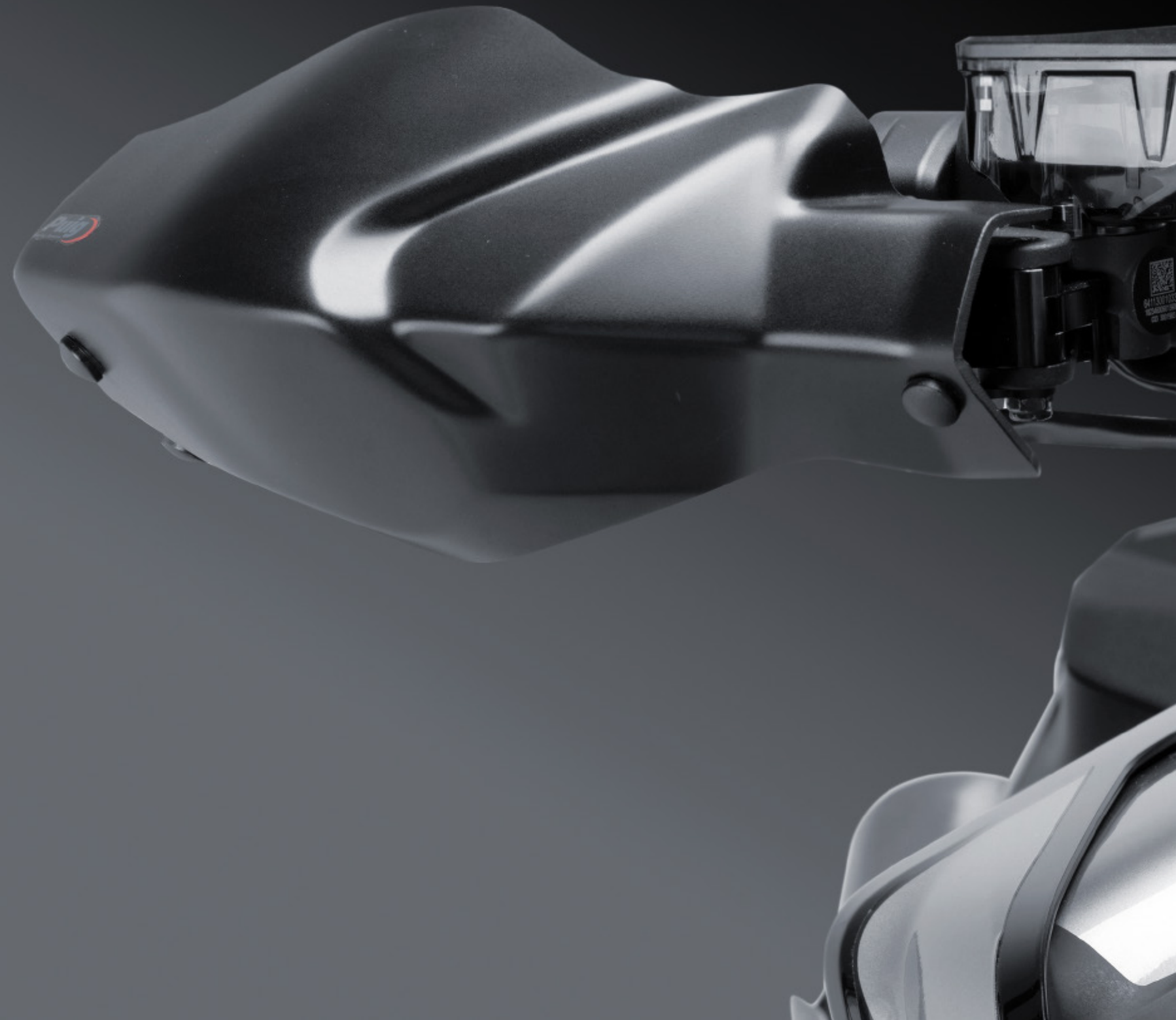

Puig offers a wide range of handguards for those motorcycles that do not have them. Manufactured in a matt black plastic material. They are light, durable and matching your motorcycle lines.

Designed with the best aerodynamic software to protect your hands and arms from the rain, air and possible small impacts from small rocks or insects.

Available in two models according to the protection or style you prefer, sport or touring.

FOR SPECIFIC MODELS SEE PAGE 266.

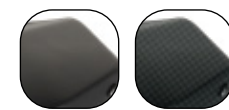

J Matt black C Carbon look

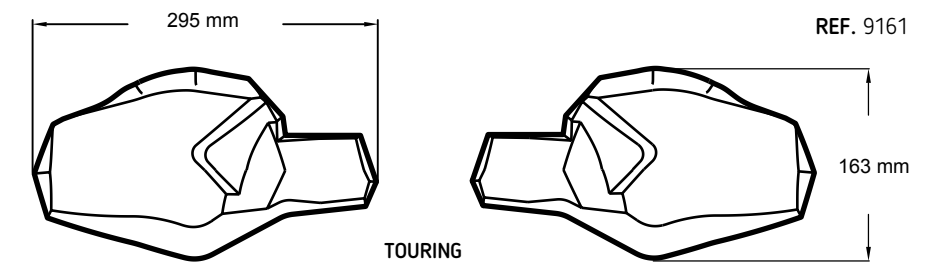
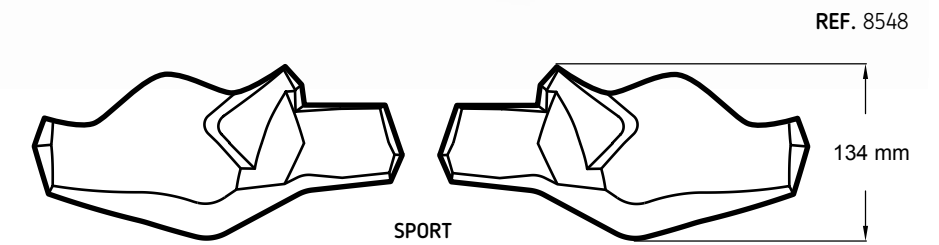

MOTORCYCLE HANDGUARD EXTENSIONS

HI-TECH PARTS | TECHNICAL SECTION

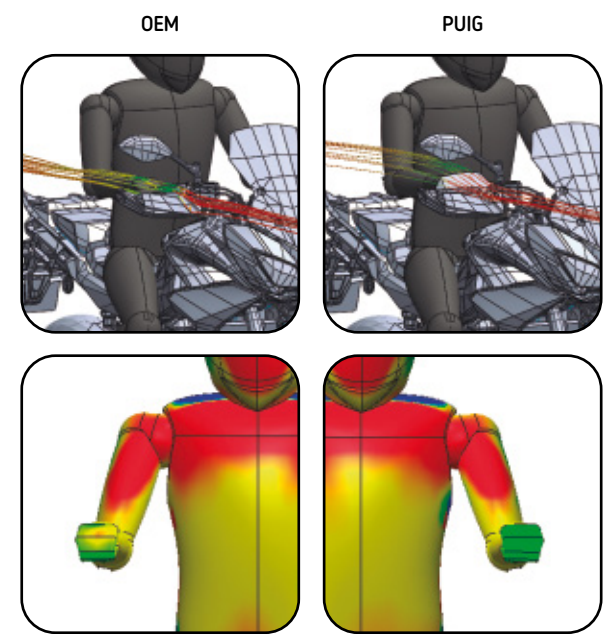

The Puig handguard extension is a product destined to the client that looks for maximum protection or that suffers from the impact of the wind on his arms and shoulders.

These small and discrete parts have been specially designed through a comprehensive aerodynamic study to redirect air flow, water or small impacts to your upper arms and thus offering the best riding comfort.

FOR SPECIFIC MODELS SEE PAGE 266.

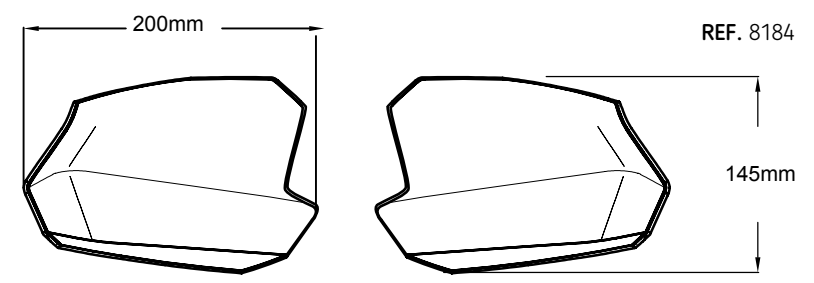

MAXISCOOTER HANDGUARDS

HI-TECH PARTS | TECHNICAL SECTION

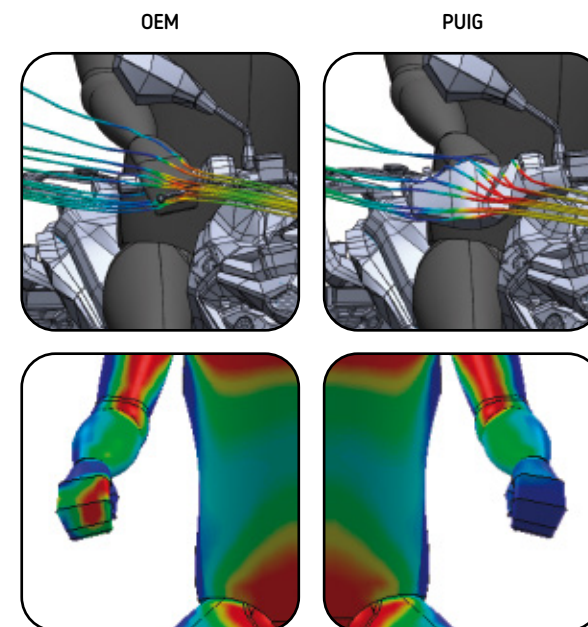

Puig offers a line of handguards for Scooters and Maxiscooters. They are fabricated in very durable material, they are light and made with soft and discrete lines that will match your motorcycle perfectly.

Designed with the best aerodynamic software to protect your hands and arms from the rain, air and possible small impacts from small rocks or insects.

Available in three shades, smoke, dark smoke and transparent.

FOR SPECIFIC MODELS SEE PAGE 266.

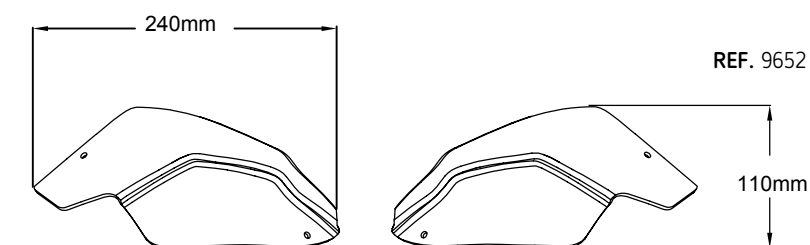

HANDGUARDS

HI-TECH PARTS | TYPE OF HANDGUARDS:

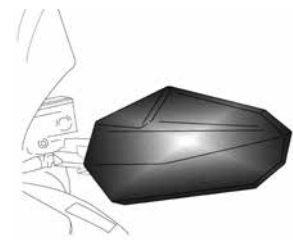

MAXISCOOTER HANDGUARDS

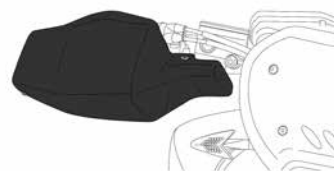

MOTORCYCLE HANDGUARDS

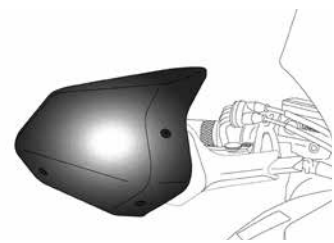

EXTENSION MOTORCYCLE HANDGUARDS

2021 MODELS: www.puig.tv

MODEL	YEAR	TYPE OF HANGUARDS	MATERIAL	ADHESIVE KIT	REF.	J	C	W H F T
BMW								
F750 GS	18' - 20'	EXTENSION	PMMA	NOT INCLUDED	3763			(*)
F800 R	15' - 19'	MOTORBIKE TOURING	ABS	INCLUDED	8939	(*)		
F800 GS	13' - 17'	MOTORBIKE TOURING	ABS	INCLUDED	8939	(*)		
F800GS ADVENTURE	13' - 18'	EXTENSION	PMMA	NOT INCLUDED	3763			(*)
F850GS	18' - 20'	EXTENSION	PMMA	NOT INCLUDED	3763			(*)
F850GS ADVENTURE	19' - 20'	EXTENSION	PMMA	NOT INCLUDED	3763			(*)
F900XR	20'	EXTENSION	PMMA	NOT INCLUDED	3763			(*)
G310 GS	17' - 20'	MOTORBIKE TOURING	ABS	INCLUDED	9881	(*)		
G310 R	16' - 20'	MOTORBIKE TOURING	ABS	INCLUDED	9881	(*)		
G650 GS	11' - 16'	MOTORBIKE TOURING	ABS	INCLUDED	8937	(*)		
R1200 GS	13' - 18'	EXTENSION	PMMA	NOT INCLUDED	3763			(*)
R1200GS EXCLUSIVE	17' - 18'	EXTENSION	PMMA	NOT INCLUDED	3763			(*)
R1200GS RALLYE	17' - 18'	EXTENSION	PMMA	NOT INCLUDED	3763			(*)
R1200GS ADVENTURE	14' - 18'	EXTENSION	PMMA	NOT INCLUDED	3763			(*)
R1200 R	15' - 18'	MOTORBIKE TOURING	ABS	INCLUDED	8940	(*)		
R1250GS	18' - 20'	EXTENSION	PMMA	NOT INCLUDED	3763			(*)
R1250GS HP	18' - 20'	EXTENSION	PMMA	NOT INCLUDED	3763			(*)
R1250GS ADVENTURE	18' - 20'	EXTENSION	PMMA	NOT INCLUDED	3763			(*)
R1250R	19' - 20'	MOTORBIKE TOURING	ABS	INCLUDED	8940	(*)		
R NINE T	14' - 20'	MOTORBIKE TOURING	ABS	INCLUDED	9393	(*)		
R NINE T SCRAMBLER	15' - 20'	MOTORBIKE TOURING	ABS	INCLUDED	9393	(*)		
S1000 XR	15' - 19'	EXTENSION	PMMA	NOT INCLUDED	3763			(*)
S1000 XR	20'	EXTENSION	PMMA	NOT INCLUDED	3763			(*)
DUCATI								
SCRAMBLER SIXTY2	16' - 20'	MOTORBIKE TOURING	ABS	INCLUDED	8949	(*)		
HONDA								
CB500F	16 - 20'	MOTORBIKE TOURING	ABS	INCLUDED	9236	(*)		
CB500X	13' - 18'	MOTORBIKE TOURING	ABS	INCLUDED	8943	(*)		
CB650F	14' - 16'	MOTORBIKE TOURING	ABS	INCLUDED	8944	(*)		
CROSSRUNNER	15' - 20'	MOTORBIKE TOURING	ABS	INCLUDED	8946	(*)		
CRF1000L AFRICA TWIN	12' - 19'	EXTENSION	PMMA	NOT INCLUDED	8948			(*)

2021 MODELS: www.puig.tv

MODEL	YEAR	TYPE OF HANGUARDS	MATERIAL	ADHESIVE KIT	REF.	J	C	W H F T
CRF1100L AFRICA TWIN	20'	EXTENSION	PMMA	NOT INCLUDED	3824			(*)
CRF1100L AFRICA TWIN ADVENTURE SPORTS	20'	EXTENSION	PMMA	NOT INCLUDED	3824			(*)
INTEGRA 750	14' - 20'	MAXISCOOTER	PMMA	NOT INCLUDED	9652			(*)
INTEGRA 750S	14' - 20'	MAXISCOOTER	PMMA	NOT INCLUDED	9652			(*)
NC700X	12' - 13'	MOTORBIKE TOURING	ABS	INCLUDED	8549	(*)		
NC750S	16' - 20'	MOTORBIKE TOURING	ABS	INCLUDED	8549	(*)		
NC750X	14' - 20'	MOTORBIKE TOURING	ABS	INCLUDED	8549	(*)		
PCX 125	14' - 20'	MAXISCOOTER	PMMA	NOT INCLUDED	9652			(*)
PCX 150	18' - 20'	MAXISCOOTER	PMMA	NOT INCLUDED	9652			(*)
X-ADV	17' - 20'	MAXISCOOTER	PMMA	NOT INCLUDED	9652			(*)
X-ADV	17' - 20'	EXTENSION	PMMA	INCLUDED	3621			(*)
KAWASAKI								
J125	16' - 20'	MAXISCOOTER	PMMA	NOT INCLUDED	3488			(*)
J300	14' - 20'	MAXISCOOTER	PMMA	NOT INCLUDED	3488			(*)
VERSYS 650	10' - 14'	MOTORBIKE TOURING	ABS	INCLUDED	8952	(*)		
VERSYS 650	15' - 20'	MOTORBIKE TOURING	ABS	INCLUDED	8951	(*)		
VERSYS 1000	15' - 18'	MOTORBIKE TOURING	ABS	INCLUDED	8951	(*)		
Z650	17' - 20'	MOTORBIKE TOURING	ABS	INCLUDED	9398	(*)		
Z900	17' - 20'	MOTORBIKE TOURING	ABS	INCLUDED	9398	(*)		
KTM								
390 ADVENTURE	20'	EXTENSION	PMMA	NOT INCLUDED	9622			(*)
690 DUKE	16' - 18'	EXTENSION	PMMA	NOT INCLUDED	9622			(*)
690 DUKE R	16' - 17'	EXTENSION	PMMA	NOT INCLUDED	9622			(*)
690 ENDURO R	19' - 20'	EXTENSION	PMMA	NOT INCLUDED	9622			(*)
690 SMC R	19' - 20'	EXTENSION	PMMA	NOT INCLUDED	9622			(*)
790 ADVENTURE/R	19' - 20'	EXTENSION	PMMA	NOT INCLUDED	3589			(*)
790 ADVENTURE R RALLY	20'	EXTENSION	PMMA	NOT INCLUDED	9622			(*)
790 DUKE	18' - 20'	EXTENSION	PMMA	NOT INCLUDED	9622			(*)
790 DUKE	18' - 20'	MOTORBIKE TOURING	ABS	INCLUDED	0072	(*)		
890 DUKE R	20'	EXTENSION	PMMA	NOT INCLUDED	9622			(*)
990 SUPERMOTO	08' - 13'	EXTENSION	PMMA	NOT INCLUDED	9622			(*)
990 SUPERMOTO R	09' - 13'	EXTENSION	PMMA	NOT INCLUDED	9622			(*)
1050 ADVENTURE	15' - 16'	EXTENSION	PMMA	NOT INCLUDED	9622			(*)
1090 ADVENTURE/R	17' - 20'	EXTENSION	PMMA	NOT INCLUDED	9622			(*)
1190 ADVENTURE/R	13' - 16'	EXTENSION	PMMA	NOT INCLUDED	9622			(*)
1290 SUPERDUKE R	14' - 20'	EXTENSION	PMMA	NOT INCLUDED	9622			(*)
1290 SUPERDUKE GT	16' - 20'	MOTORBIKE TOURING	ABS	INCLUDED	9186	(*)		
1290 SUPER ADVENTURE	15' - 16'	EXTENSION	PMMA	NOT INCLUDED	9622			(*)
1290 SUPER ADVENTURE T	17'	EXTENSION	PMMA	NOT INCLUDED	9622			(*)



(*) Check price with your distributor.

IMPORTANT: Indicate code color after part#. Example 0973A

HANDGUARDS

HI-TECH PARTS | TYPE OF HANDGUARDS:

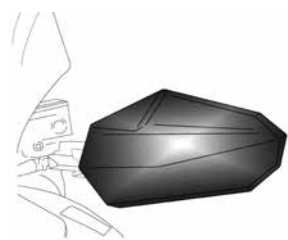

MAXISCOOTER HANDGUARDS

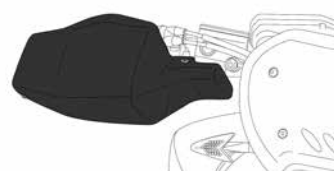

MOTORCYCLE HANDGUARDS

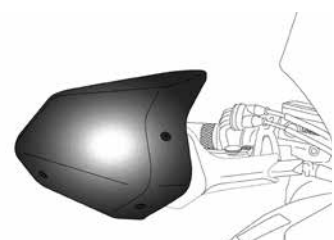

EXTENSION MOTORCYCLE HANDGUARDS

2021 MODELS: www.puig.tv

MODEL	YEAR	TYPE OF HANGUARDS	MATERIAL	ADHESIVE KIT	REF.	J	C	W H F T
1290 SUPER ADVENTURE R	17' - 20'	EXTENSION	PMMA	NOT INCLUDED	9622			(*)
1290 SUPER ADVENTURE S	17' - 20'	EXTENSION	PMMA	NOT INCLUDED	9622			(*)
KYMCO								
AK550	17' - 20'	MAXISCOOTER	PMMA	NOT INCLUDED	9652			(*)
DOWNTOWN 125i	09' - 14'	MAXISCOOTER	PMMA	NOT INCLUDED	9652			(*)
DOWNTOWN 300i	09' - 14'	MAXISCOOTER	PMMA	NOT INCLUDED	9652			(*)
GRAND DINK 125	16' - 20'	MAXISCOOTER	PMMA	NOT INCLUDED	9652			(*)
GRAND DINK 300	16' - 20'	MAXISCOOTER	PMMA	NOT INCLUDED	9652			(*)
G-DINK 50	12' - 18'	MAXISCOOTER	PMMA	NOT INCLUDED	9652			(*)
G-DINK 125i	12' - 18'	MAXISCOOTER	PMMA	NOT INCLUDED	9652			(*)
G-DINK 300i	12' - 18'	MAXISCOOTER	PMMA	NOT INCLUDED	9652			(*)
K-XCT 125i	13' - 16'	MAXISCOOTER	PMMA	NOT INCLUDED	9652			(*)
K-XCT 300i	13' - 16'	MAXISCOOTER	PMMA	NOT INCLUDED	9652			(*)
NEW DOWNTOWN 125i	15' - 20'	MAXISCOOTER	PMMA	NOT INCLUDED	9652			(*)
NEW DOWNTOWN 350i	15' - 20'	MAXISCOOTER	PMMA	NOT INCLUDED	9652			(*)
SUPERDINK 125i	09' - 20'	MAXISCOOTER	PMMA	NOT INCLUDED	9652			(*)
SUPERDINK 350i	09' - 20'	MAXISCOOTER	PMMA	NOT INCLUDED	9652			(*)
XCITING 400i	14' - 16'	MAXISCOOTER	PMMA	NOT INCLUDED	9652			(*)
X-TOWN 125	16' - 20'	MAXISCOOTER	PMMA	NOT INCLUDED	9652			(*)
X-TOWN 300	16' - 20'	MAXISCOOTER	PMMA	NOT INCLUDED	9652			(*)
YAGER GT 125i	13' - 18'	MAXISCOOTER	PMMA	NOT INCLUDED	9652			(*)
YAGER GT 300i	13' - 18'	MAXISCOOTER	PMMA	NOT INCLUDED	9652			(*)
SUZUKI								
BURGMAN 125	10' - 20'	MAXISCOOTER	PMMA	NOT INCLUDED	9652			(*)
BURGMAN 400	17' - 20'	MAXISCOOTER	PMMA	NOT INCLUDED	9652			(*)
DL1000 V-STROM	14' - 16'	MOTORBIKE TOURING	ABS	INCLUDED	8950	(*)		
TRIUMPH								
SPEED TRIPLE/R	16' - 20'	MOTORBIKE TOURING	ABS	INCLUDED	9255			
TIGER 800	11' - 14'	MOTORBIKE TOURING	ABS	INCLUDED	8953	(*)		
TIGER 800 XC	11' - 14'	MOTORBIKE TOURING	ABS	INCLUDED	8953	(*)		
TIGER 800 XC/XC/XCA	15' - 20'	MOTORBIKE TOURING	ABS	INCLUDED	8953	(*)		
TIGER 800 XR/XR/XRT	15' - 20'	MOTORBIKE TOURING	ABS	INCLUDED	8953	(*)		

2021 MODELS: www.puig.tv

MODEL	YEAR	TYPE OF HANGUARDS	MATERIAL	ADHESIVE KIT	REF.	J	C	W H F T
TIGER 900	20'	EXTENSION	PMMA	NOT INCLUDED	20378			(*)
TIGER 900 GT	20'	EXTENSION	PMMA	NOT INCLUDED	20378			(*)
TIGER 900 GT LOW	20'	EXTENSION	PMMA	NOT INCLUDED	20378			(*)
TIGER 900 GT PRO	20'	EXTENSION	PMMA	NOT INCLUDED	20378			(*)
TIGER 900 RALLY	20'	EXTENSION	PMMA	NOT INCLUDED	20378			(*)
TIGER 900 RALLY PRO	20'	EXTENSION	PMMA	NOT INCLUDED	20378			(*)
YAMAHA								
MT-03	16' - 20'	MOTORBIKE SPORT	ABS	INCLUDED	8897	(*)	(*)	
MT-07	14' - 20'	MOTORBIKE TOURING	ABS	INCLUDED	8548	(*)		
MT-07	14' - 20'	MOTORBIKE SPORT	ABS	INCLUDED	9161	(*)	(*)	
MT-07 TRACER	16 - 19'	EXTENSION	PMMA	NOT INCLUDED	9214			(*)
MT-07 TRACER	20'	EXTENSION	PMMA	NOT INCLUDED	20436			(*)
MT-07 TRACER GT	19'	EXTENSION	PMMA	NOT INCLUDED	9214			(*)
MT-09	13' - 20'	MOTORBIKE TOURING	ABS	INCLUDED	8548	(*)		
MT-09	13' - 20'	MOTORBIKE SPORT	ABS	INCLUDED	9161	(*)	(*)	
MT-09 SP	18' - 20'	MOTORBIKE TOURING	ABS	INCLUDED	8548	(*)		
MT-09 SP	18' - 20'	MOTORBIKE SPORT	ABS	INCLUDED	9161	(*)	(*)	
MT-09 TRACER	15' - 17'	EXTENSION	PMMA	NOT INCLUDED	8184			(*)
MT-09 TRACER	18' - 20'	EXTENSION	PMMA	NOT INCLUDED	9727			(*)
MT-09 TRACER GT	18' - 20'	EXTENSION	PMMA	NOT INCLUDED	9727			(*)
MT-10	16' - 20'	MOTORBIKE TOURING	ABS	INCLUDED	8548	(*)		
MT-10	16' - 20'	MOTORBIKE SPORT	ABS	INCLUDED	9161	(*)	(*)	
MT-10 SP	17' - 20'	MOTORBIKE TOURING	ABS	INCLUDED	8548	(*)		
MT-10 SP	17' - 20'	MOTORBIKE SPORT	ABS	INCLUDED	9161	(*)	(*)	
NMAX 125	15' - 20'	MAXISCOOTER	PMMA	NOT INCLUDED	9652			(*)
TENERE 700	19' - 20'	EXTENSION	PMMA	NOT INCLUDED	3729			(*)
T-MAX 530	12' - 16'	MAXISCOOTER	PMMA	NOT INCLUDED	8200			(*)
T-MAX 530/DX/SX	17' - 19'	MAXISCOOTER	PMMA	NOT INCLUDED	8200			(*)
T-MAX 530/DX/SX	17' - 19'	MAXISCOOTER	PMMA	NOT INCLUDED	3488			(*)
T-MAX 560/DX/SX/TECH MAX	20'	MAXISCOOTER	PMMA	NOT INCLUDED	8200			(*)
T-MAX 560/DX/SX/TECH MAX	20'	MAXISCOOTER	PMMA	NOT INCLUDED	9652			(*)
X-MAX 125	14' - 20'	MAXISCOOTER	PMMA	NOT INCLUDED	8111			(*)
X-MAX 250	14' - 16'	MAXISCOOTER	PMMA	NOT INCLUDED	8111			(*)
X-MAX 300	17' - 20'	MAXISCOOTER	PMMA	NOT INCLUDED	8111			(*)
X-MAX 400	13' - 20'	MAXISCOOTER	PMMA	NOT INCLUDED	8111			(*)
XSR 700	16' - 20'	MOTORBIKE TOURING	ABS	INCLUDED	8548	(*)		
XSR 700	16' - 20'	MOTORBIKE SPORT	ABS	INCLUDED	9161	(*)	(*)	
XSR 900	16' - 20'	MOTORBIKE TOURING	ABS	INCLUDED	8548	(*)		
XSR 900	16' - 20'	MOTORBIKE SPORT	ABS	INCLUDED	9161	(*)	(*)	



J Matt black C Carbon look H Smoke F Dark Smoke W Transparent T Orange

(*) Check price with your distributor.

IMPORTANT: Indicate code color after part#. Example 0973A

HANDLEBAR DEFLECTORS

HI-TECH PARTS | TECHNICAL SECTION



REF. 9397



2021 MODELS: www.puig.tv			
MODEL	YEAR	REF.	W H F
BMW			
F750GS	18' - 20'	1319	(*)
F850GS	18' - 20'	1319	(*)
F850GS ADVENTURE	19' - 20'	1319	(*)
R1200GS	13' - 18'	9397	(*)
R1200GS ADVENTURE	14' - 18'	9397	(*)
R1200GS EXCLUSIVE	17' - 18'	9397	(*)
R1200GS RALLYE	17' - 18'	9397	(*)
R1250GS	18' - 20'	9397	(*)
R1250GS ADVENTURE	18' - 20'	9397	(*)
R1250GS HP	18' - 20'	9397	(*)
S1000 XR	15' - 18'	9397	(*)

(*) Check price with your distributor.
 IMPORTANT: Indicate code color after part#. Example: 0973A.

MOBILE PHONE SUPPORT

HI-TECH PARTS | TECHNICAL SECTION

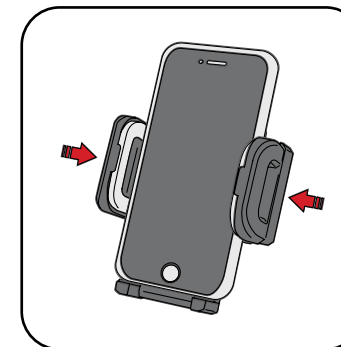
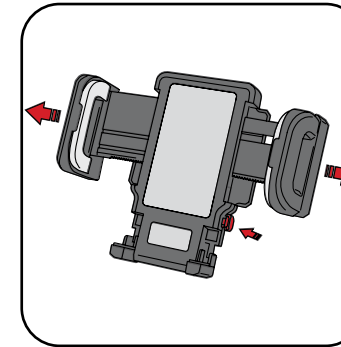
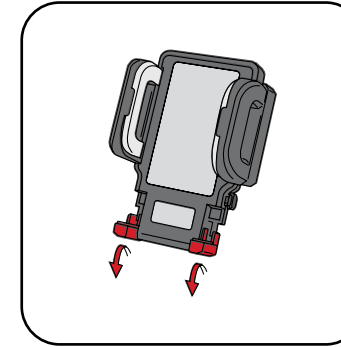
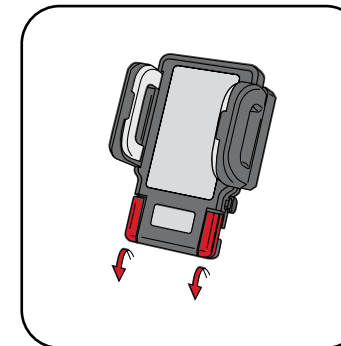

REF. 3836N

// HORIZONTAL SMARTPHONE PHONE HOLDER

Thanks to the Puig phone holder you can use your smartphone as a browser without suffering for its integrity and security. In addition, in our catalog you will find a line of accessories related to your mobile phone and its protection during journeys of all kinds and with different weather scenarios.

The support will allow you to integrate your phone comfortably and without affecting the final visibility of the road. The locking mechanism adapts to the inches of today's phones. The padded area on the sides and the back, where it rests, improves its grip, and prevents vibration that could affect its operating system.

You can mount the phone holder on the base of the mirror, the mirror rod, on the handlebar and on the seat post of the motorcycle where it will be more immobilized against possible impacts or potholes on the road.

MODEL	DIMENSIONS (mm.)	REF.	N
MOBILE PHONE SUPPORT	500 x 500 -115	3836N	(*)



N
Black

(*) Check price with your distributor.
IMPORTANT: Indicate code color after part#. Example: 0973A.

MOBILE CASE

HI-TECH PARTS | TECHNICAL SECTION



REF. 3531N
TACTILE

185 mm
30 mm
100 mm



REF. 3530N
TACTILE

165 mm
30 mm
100 mm

// LARGE MOBILE CASE

MODEL	DIMENSIONS	REF.	N
MOBILE CASE	185 x 100	3531N	(*)

// SMALL MOBILE CASE

MODEL	DIMENSIONS	REF.	N
MOBILE CASE	165 x 100	3530N	(*)



REF. 6390N

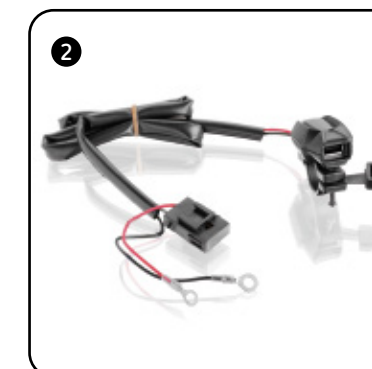

REF. 6840N



N
Black

// IN-TAKE CHARGE

MODEL	REF.	N
(1) IN-TAKE CHARGE C/BLACK	6390N	(*)
(2) USB IN-TAKE CHARGE N/BLACK INPUT:12v OUTPUT:2.5A	6840N	(*)

(*) Check price with your distributor.
IMPORTANT: Indicate code color after part#. Example: 0973A.

MOBILE SUPPORTS
HI-TECH PARTS | TECHNICAL SECTION

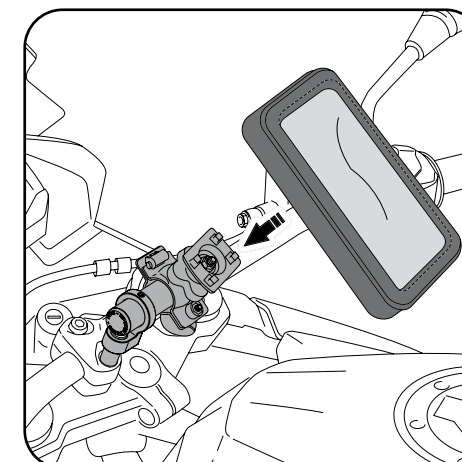
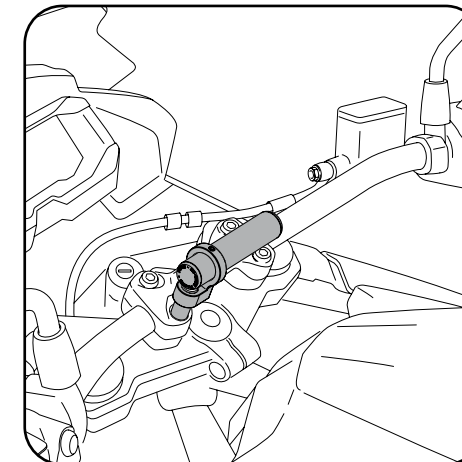
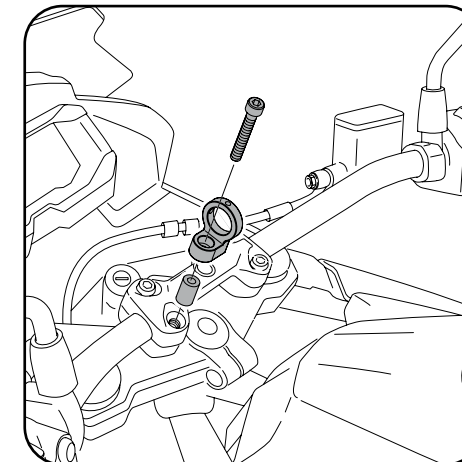

REF. 3570P

// RISERS HANDLEBAR SUPPORT

Smartphone mount of superior quality, with machined parts in billet aluminium and anodized in silver color. Diameter of the tube is 20mm and 80mm in length which allows the attachment of several products such as GPS, cel phone, etc. It attaches easily and quickly. It is offered with screws in different lengths to adapt it to any motorcycle.

It is required to purchase support 3534N. Compatible with Puig Motoplastic covers for fast application ref. 3530N and 3531N.

Available for a wide range of models, consult adjustability to the motorcycle model in the web.

MODEL	REF.	(P)
HANDLEBAR BAR SUPPORT	3570P	(*)

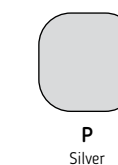

(*) Check price with your distributor.

IMPORTANT: Indicate code color after part#. Example 0973A

Check availability for motorcycle models at www.puig.tv typing in the searching window

MOBILE SUPPORTS

HI-TECH PARTS | TECHNICAL SECTION

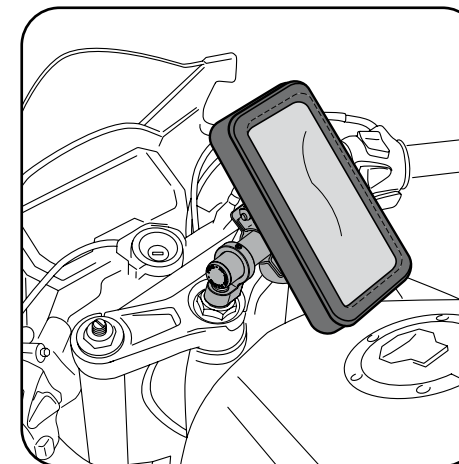
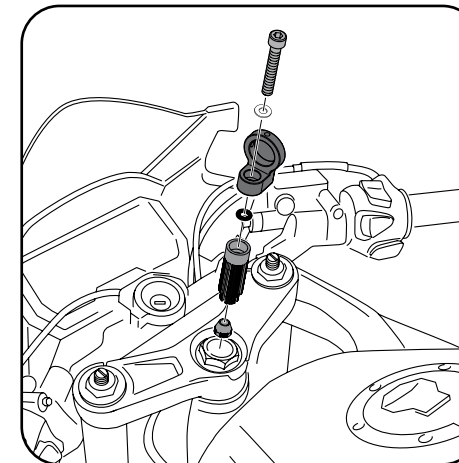
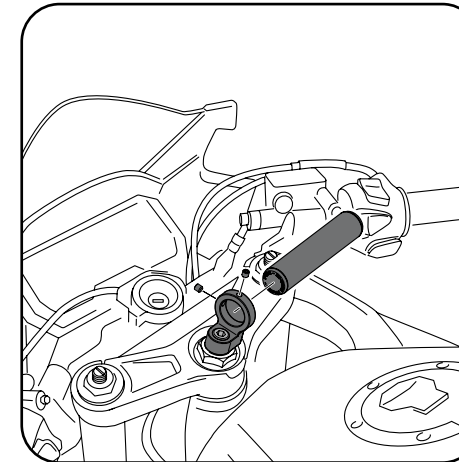

REF. 3756N



REF. 3756P



// SUPPORT TO CENTRAL HOLE YOKE

Universal support for Sport motorcycles. It is fixed in the center of the yoke axle. Allows you to adjust the inclination and lateral movement. It consists of a machined aluminum body in silver or black, with a bar of the same color and a plastic support with an adjustable hemisphere that allows a quick adjustment without tools.

It can be mounted on any motorcycle that has a hole in the yoke axle (or a plug) with dimensions between $\varnothing 13$ and $\varnothing 18$, where the stamping pin will pass. Easy to assemble. **Compatible with Puig quick fix covers ref.3530N and 3531N. Check the compatibility of the motorcycle at Puig Motoplástico website.**

Available for a wide range of models, consult adjustability to the motorcycle model in the web.

MODEL	REF.	
SUPPORT TO CENTRAL HOLE YOKE	3756N	(*)

N
BlackP
Silver

(*) Check price with your distributor.

IMPORTANT: Indicate code color after part#. Example 0973A

Check availability for motorcycle models at www.puig.tv typing in the searching window

MOBILE SUPPORTS

MOBILE SUPPORTS

HI-TECH PARTS | TECHNICAL SECTION

// HANDLEBAR

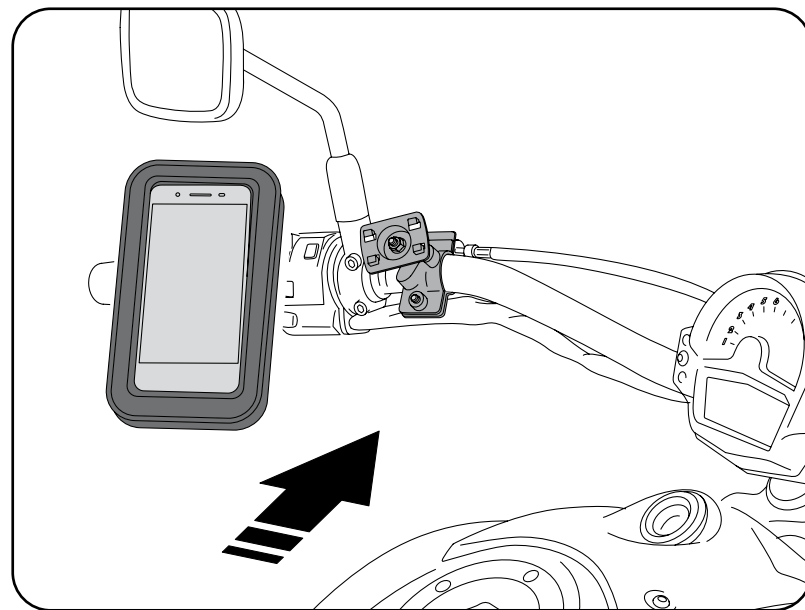

This element allows you to directly adjust the support for the Smartphone to the handlebar of the motorcycle. It is made out of two halves that adjust to each other with the handlebar in between, while they adjusted through a thumbscrew. We also offer different thickness rubber spacers, so that it ends up perfectly adjusted to the motorcycle.

This part is good for any handlebar that has a diameter of Ø20 until Ø25 mm and just like any of our supports, it is compatible with our cel phone covers.



REF. 3534N

MODEL	REF.	N
HANDLEBAR BRACKET	3534N	(*)

(*) Check price with your distributor.

IMPORTANT: Indicate code color after part#. Example 0973A

Check availability for motorcycle models at www.puig.tv typing in the searching window

MOBILE SUPPORTS

// REARVIEW MIRROR BASE

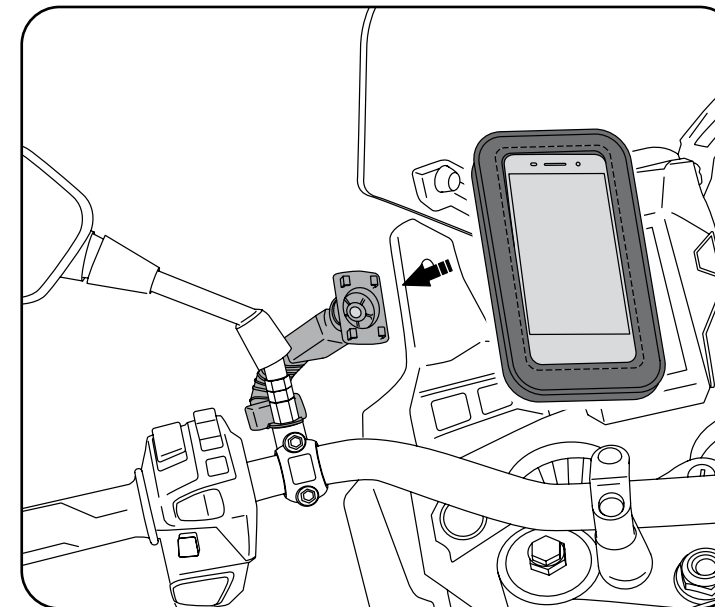

// REARVIEW MIRROR ROD

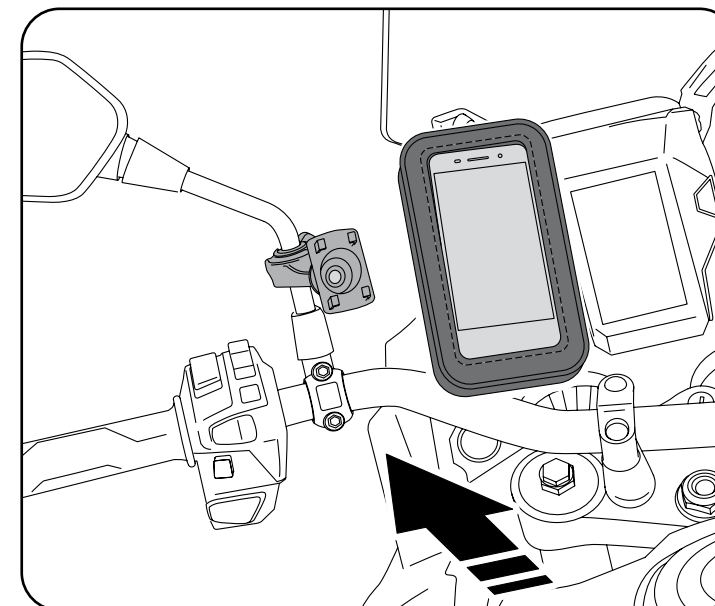

Support for the rearview mirror base, it is an universal support with complete mobility, 360° and also allows 100% adjustability to guarantee the best view during the ride, so the rider doesn't lose focus of the road.

The support is made of a metal base and a semi-rigid arm that guarantees a perfect attachment to the base of the rearview mirror. This support is good for all those motorcycle models that carry the rearview mirrors over the handlebars and are also compatible with Puig's covers.



REF. 3532N

MODEL	REF.	N
REARVIEW BASE SUPPORT	3532N	(*)

A support of easy and quick application, where the plastic cover hugs the rearview mirror rod and it is attached by a thumbscrew. It is offered with different rubber spacers, of different thickness, to adapt it to the different motorcycles needs.

This support is good for mounting over any rearview mirror with a cylindrical rod of Ø0 until Ø25 and just like the last one it is compatible with our covers.



REF. 3533N

MODEL	REF.	N
REAR VIEW MIRROR SUPPORT	3533N	(*)

(*) Check price with your distributor.

IMPORTANT: Indicate code color after part#. Example 0973A

Check availability for motorcycle models at www.puig.tv typing in the searching window

MOBILE SUPPORTS

N
BlackN
Black

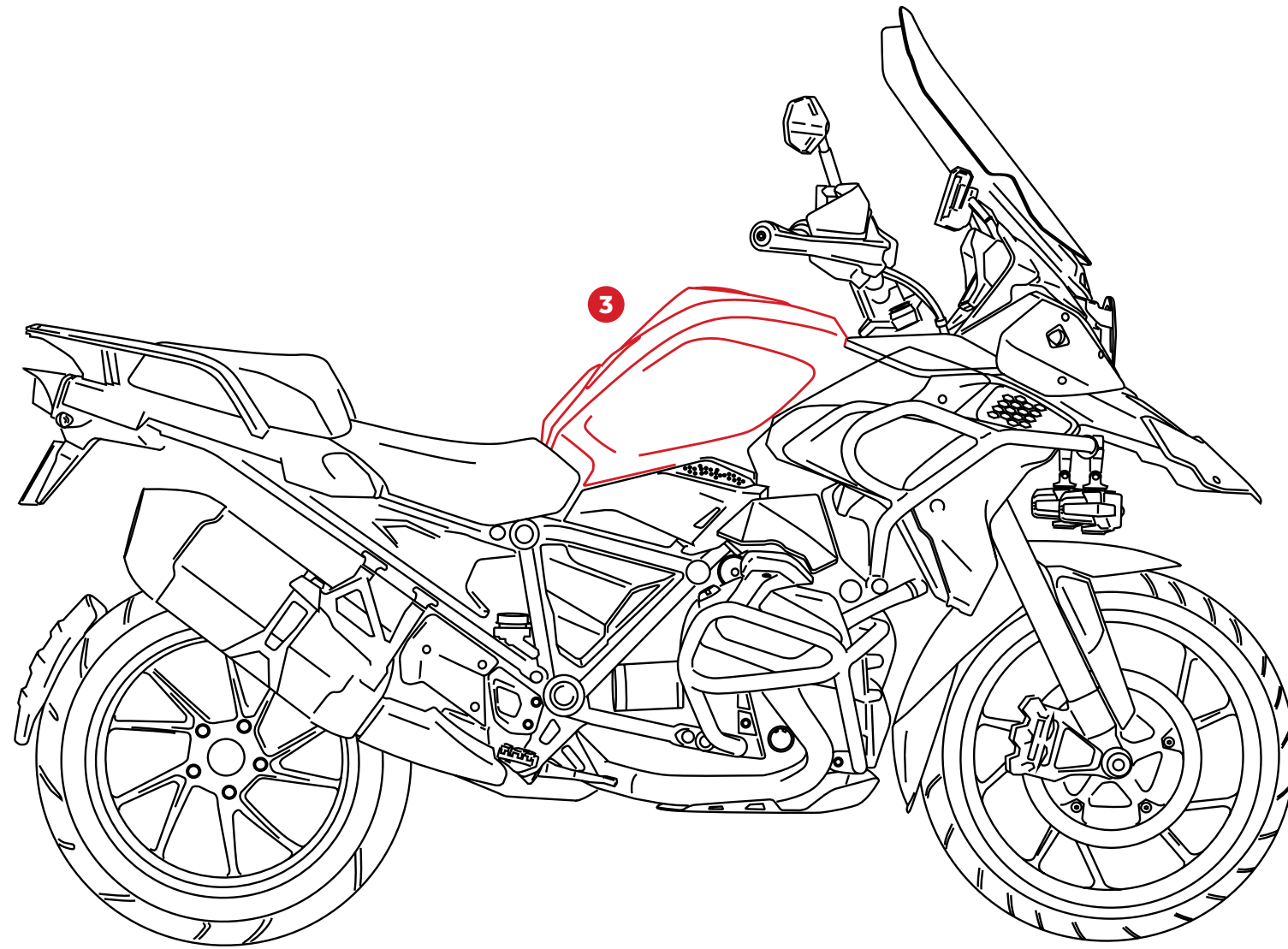

GAS TANK AREA

ADHESIVE FOAM SEAT	321
ADHESIVE NAKED YOKE & TANK PADS	289
ADHESIVE RADIKAL YOKE & TANK PADS	293
ADHESIVE TANK PADS	301
ADHESIVE X-TREME YOKE & TANK PADS	297
BUMPS-SHEET	321
FLAT SHEET	321
HANDHOLDS	285
SCRATCH PADS PROTECTOR	323
TANK PADS SPIRIT	313
TANK PADS DREI	306
TANK PADS FUTURE / VIOLENT / SPIRIT II / ONE	315
TANK PADS MOON / SCREAM / JOKER / CLOWN	317
TANK PADS PERFORMANCE	307
TANK PADS PERFORMANCE 2	308
TANK PADS MINI/ARROW/WAY/SUN	319
TANK PADS SKULL / SKULL I / COLOURY	320
TANK PADS TIRE / LEATHER / SOFT	309
TANK PADS WINGS	311
TANK SIDE PROTECTORS ANTI-SLIP	303

HANDHOLDS

HI-TECH PARTS

2021 MODELS: www.puig.tv

MODEL	YEAR	N° SCREWS	REF.	N
APRILIA				
RSV4	09' - 12'	WITHOUT SCREWS	3615N	(*)
RSV4 FACTORY	13' - 14'	WITHOUT SCREWS	3615N	(*)
RSV4 R	13' - 14'	WITHOUT SCREWS	3615N	(*)
RSV4 RF/RR	15' - 20'	WITHOUT SCREWS	9035N	(*)
SHIVER 750	07' - 20'	WITHOUT SCREWS	5148N	(*)
SHIVER 900	17' - 20'	WITHOUT SCREWS	5148N	(*)
TUONO V4R	11' - 14'	WITHOUT SCREWS	9035N	(*)
TUONO V4 1100 RR	15' - 20'	WITHOUT SCREWS	9035N	(*)
TUONO V4 1100 FACTORY	15' - 20'	WITHOUT SCREWS	9035N	(*)
BMW				
F900R	20'	6	9037N	(*)
F900XR	20'	6	9037N	(*)
G310R	16' - 20'	WITHOUT SCREWS	5148N	(*)
R1250R	19' - 20'	6	9037N	(*)
R1250RS	19' - 20'	6	9037N	(*)
S1000 R	14' - 20'	WITHOUT SCREWS	6741N	(*)
S1000 RR	09' - 20'	WITHOUT SCREWS	6741N	(*)
DUCATI				
1199 PANIGALE	12' - 14'	WITHOUT SCREWS	9035N	(*)
1299 PANIGALE/S	15' - 17'	WITHOUT SCREWS	9035N	(*)

N
Black2021 MODELS: www.puig.tv

MODEL	YEAR	N° SCREWS	REF.	N
959 PANIGALE	16' - 20'	WITHOUT SCREWS	9035N	(*)
959 PANIGALE CORSE	18' - 20'	WITHOUT SCREWS	9035N	(*)
PANIGALE 1100 V4	18' - 20'	WITHOUT SCREWS	9035N	(*)
PANIGALE 1100 V4S	18' - 20'	WITHOUT SCREWS	9035N	(*)
PANIGALE 1100 V4R	19' - 20'	WITHOUT SCREWS	9035N	(*)
SUPERSPORT 939/S	17' - 20'	5	5149N	(*)
STREETFIGHTER V4/S	20'	WITHOUT SCREWS	9035N	(*)
HONDA				
CB500F	19' - 20'	5	9036N	(*)
CBR600F	91' - 07'	7	4614N	(*)
CBR500R	16' - 20'	5	9036N	(*)
CBR600RR	03' - 13'	7	4614N	(*)
CBR650R	19' - 20'	5	9036N	(*)
CBR900RR FIRE BLADE	92' - 03'	7	4614N	(*)
CBR1000RR FIRE BLADE	04' - 14'	7	4614N	(*)
CBR1000RR FIRE BLADE	15' - 20'	5	9036N	(*)
CBR1100XX BLACKBIRD	97' - 07'	7	4614N	(*)
NT650 REVERE	88' - 98'	7	4614N	(*)
VFR800F	98' - 01'	7	4614N	(*)
VFR800F	15' - 18'	5	9036N	(*)
VFR800	02' - 13'	7	4614N	(*)
VFR1200F	10' - 16'	7	4614N	(*)
VTR1000F FIRE STORM	97' - 07'	7	4614N	(*)
VTR1000 SP-1	00' - 02'	7	4614N	(*)
VTR1000 SP-2	02' - 05'	7	4614N	(*)
KAWASAKI				
ER-6F	06' - 16'	5	4613N	(*)
ER-6N	05' - 16'	5	4613N	(*)
GT1400	07' - 16'	5	4613N	(*)

MADE IN LIGHT ALUMINIUM.

(*) Check price with your distributor.

IMPORTANT: Indicate code color after part#. Example: 0973A

HANDHOLDS

HI-TECH PARTS

2021 MODELS: www.puig.tv

MODEL	YEAR	Nº SCREWS	REF.	N
NINJA 250R	08' - 12'	6	6742N	(*)
NINJA 300	13' - 15'	6	6742N	(*)
NINJA 400	18' - 20'	WITHOUT SCREWS	3761N	(*)
NINJA 650	17' - 20'	WITHOUT SCREWS	3761N	(*)
NINJA H2 SX	20'	WITHOUT SCREWS	3761N	(*)
NINJA 1000 SX	20'	WITHOUT SCREWS	3761N	(*)
Z250SL	15' - 17'	6	6742N	(*)
Z400	19' - 20'	WITHOUT SCREWS	3761N	(*)
Z650	17' - 20'	WITHOUT SCREWS	3761N	(*)
Z750	07' - 12'	5	4613N	(*)
Z750R	11' - 12'	5	4613N	(*)
Z800	13' - 16'	5	4613N	(*)
Z900	17' - 20'	WITHOUT SCREWS	3761N	(*)
Z1000	03' - 13'	5	4613N	(*)
Z1000	14' - 20'	5	9700N	(*)
Z1000SX	17' - 19'	5	4613N	(*)
ZX-6R	00' - 16'	5	4613N	(*)
ZX-6R	18' - 20'	WITHOUT SCREWS	3761N	(*)
ZX-6R 636	13' - 16'	5	4613N	(*)
ZX-10R	04' - 20'	5	4613N	(*)
ZZR1400	06' - 20'	5	4613N	(*)
KTM				
1290 SUPERDUKE R	14' - 20'	6	9037N	(*)
MV AGUSTA				
F3 675	12' - 20'	6	9038N	(*)
F4	10' - 20'	5	5150N	(*)
F4 750	99' - 04'	5	5150N	(*)



N
Black

2021 MODELS: www.puig.tv

MODEL	YEAR	Nº SCREWS	REF.	N
BRUTALE	05' - 09'	5	5150N	(*)
BRUTALE 675	12' - 16'	6	9038N	(*)
BRUTALE 800/RR	13' - 16'	6	9038N	(*)
BRUTALE 1090 RR	13' - 18'	WITHOUT SCREWS	3616N	(*)
DRAGSTER 800/RR	14' - 16'	6	9038N	(*)
RIVALE 800	13' - 16'	6	9038N	(*)
SUZUKI				
BANDIT 1250F	17'	5	4612N	(*)
GSF650 BANDIT	05' - 17'	5	4612N	(*)
GSF650S BANDIT	05' - 14'	5	4612N	(*)
GSF650S BANDIT	07' - 14'	7	6842N	(*)
GSR600	05' - 13'	5	4612N	(*)
GSR750	11' - 16'	5	4612N	(*)
GSX650	05' - 17'	5	4612N	(*)
GSX-R250	17' - 20'	5	4612N	(*)
GSX-R300	17' - 20'	5	4612N	(*)
GSX-R150	18' - 20'	5	4611N	(*)
GSX-R600	04' - 17'	5	4611N	(*)
GSX-R750	93' - 03'	7	6842N	(*)
GSX-R750	04' - 17'	5	4611N	(*)
GSX-R1000	03' - 04'	5	4612N	(*)
GSX-R1000	05' - 18'	5	4611N	(*)
GSX-R1000	19' - 20'	5	4612N	(*)
GSX-R1300 HAYABUSA	99' - 07'	7	6842N	(*)
GSX-R1300 HAYABUSA	08' - 15'	5	4612N	(*)
GSX-R600	98' - 03'	7	6842N	(*)
GSX-S750	17' - 20'	5	4612N	(*)
GSX-S1000	15' - 20'	5	4612N	(*)
GSX-S1000F	15' - 20'	5	4612N	(*)
GSX1250F	17'	5	4612N	(*)
INAZUMA	13' - 17'	5	4612N	(*)
KATANA	19' - 20'	5	4612N	(*)
SV1000	00' - 03'	7	6842N	(*)
SV650	00' - 03'	7	6842N	(*)

MADE IN LIGHT ALUMINIUM.

(*) Check price with your distributor.

IMPORTANT: Indicate code color after part#. Example: 0973A

2021 MODELS: www.puig.tv

MODEL	YEAR	Nº SCREWS	REF.	N
SFV650 GLADIUS	09' - 15'	5	4612N	(*)
SV650	04' - 08'	5	4611N	(*)
SV650	16' - 17'	5	4612N	(*)
SV650X	18' - 20'	5	4612N	(*)
SV1000	04'-07'	5	4611N	(*)
TRIUMPH				
DAYTONA 675/R	06' - 19'	6	5148N	(*)
DAYTONA 955i	02' - 06'	6	5148N	(*)
SPEED FOUR 600	00' - 06'	6	5148N	(*)
SPEED TRIPLE	08' - 20'	6	5148N	(*)
SPRINT ST	08' - 15'	6	5148N	(*)
STREET TRIPLE/R	08' - 19'	6	5148N	(*)
STREET TRIPLE R/S	20'	6	5148N	(*)
STREET TRIPLE RS	18' - 20'	6	5148N	(*)
YAMAHA				
FAZER8	13' - 16'	5	4616N	(*)
FZ1/ FZ1 FAZER	06' - 15'	5	4616N	(*)
FZ6	04' - 06'	5	4616N	(*)
FZ6 FAZER	07' - 08'	5	4616N	(*)
FZ8	10' - 16'	5	4616N	(*)
FZ8 FAZER	10' - 12'	5	4616N	(*)
MT-01	05' - 13'	5	4616N	(*)
MT-03	06' - 14'	5	4616N	(*)
MT-09	13' - 20'	5	4616N	(*)
MT-09 SP	18' - 20'	5	4616N	(*)
MT-10	16' - 20'	3	9039N	(*)
NIKEN	18' - 20'	5	4616N	(*)
XJ6	09' - 16'	5	4616N	(*)
XJ6 DIVERSION	09' - 16'	5	4616N	(*)
XJ6 DIVERSION F	10' - 16'	5	4616N	(*)
YZF-R1	02' - 14'	5	4615N	(*)
YZF-R1	15' - 20'	3	9040N	(*)
YZF-R3	18'	5	4615N	(*)
YZF-R3	19' - 20'	3	9040N	(*)
YZF-R6	04' - 16'	5	4615N	(*)



N
Black

MADE IN LIGHT ALUMINIUM.

(*) Check price with your distributor.

IMPORTANT: Indicate code color after part#. Example: 0973A

ADHESIVE NAKED YOKE & TANK PADS HI-TECH PARTS



// TANK PAD

MODEL	REF.	U
UNIVERSAL	6291U	(*)



// PLUG DEPOSIT PROTECTOR

MODEL	REF.	U
SPECIFIC MODELS (#)	CHECK OUR WEBSITE	(*)



// YOKE PROTECTOR

MODEL	REF.	U
SPECIFIC MODELS	CHECK OUR WEBSITE	(*)

(#) DRAWINGS OF ALL FUEL CAP PROTECTORS AVAILABLE SEE PAGE 290.

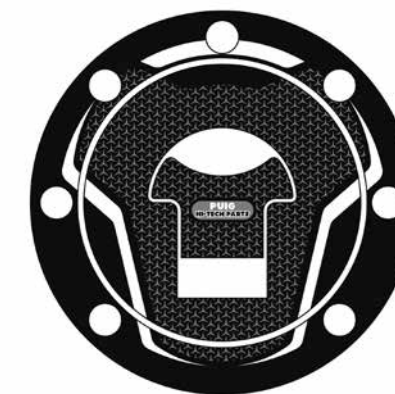

(*) Check price with your distributor.

IMPORTANT: Indicate code color after part#. Example 0973A

Check availability for motorcycle models at www.puig.tv typing in the searching window

TANKPAD NAKED

NAKED FUEL CAP COVER

HI-TECH PARTS

2021 MODELS: www.puig.tv

2021 MODELS: www.puig.tv

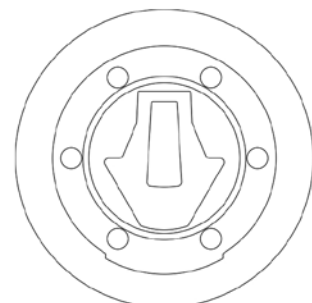

3698

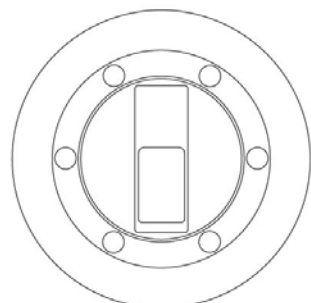

6293

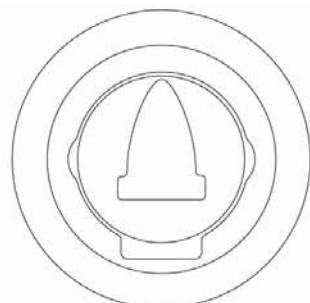

6295

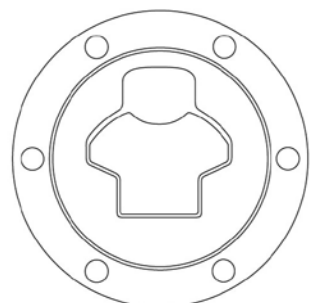

6297

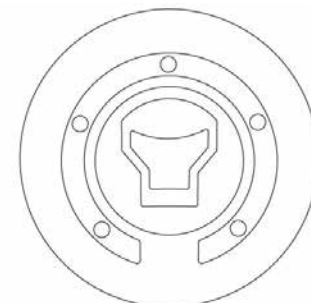

7571

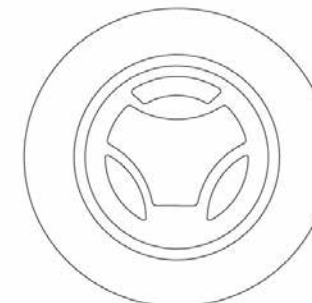

7583

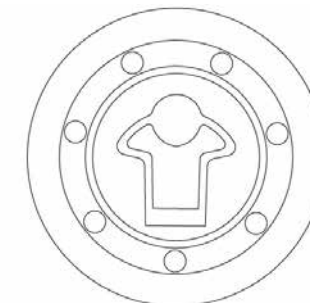

7610

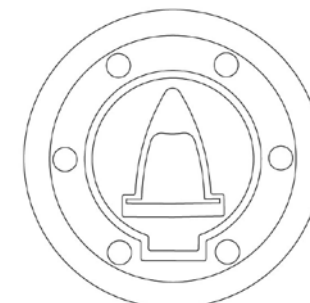

8172

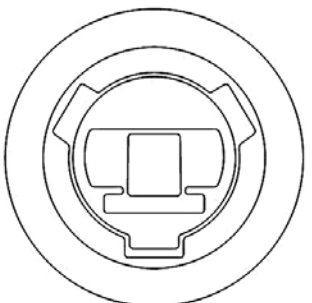

6299

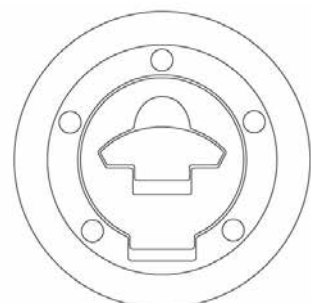

6303

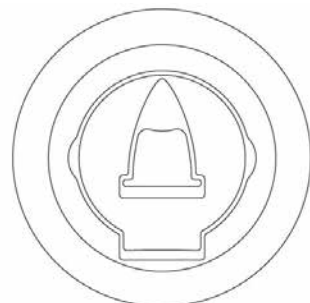

6305



6307

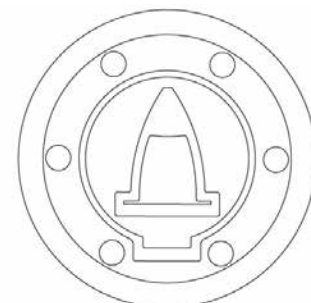

8236

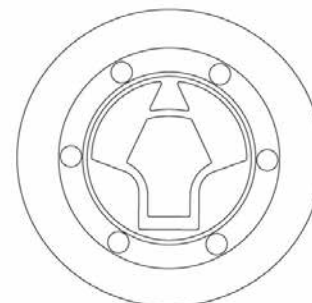

8242

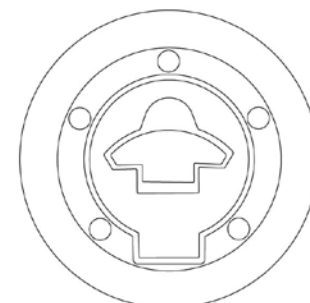

8254

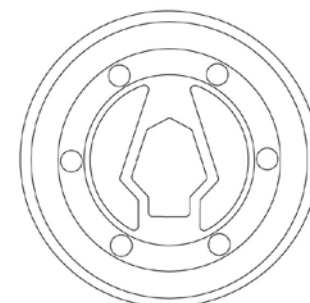

8968

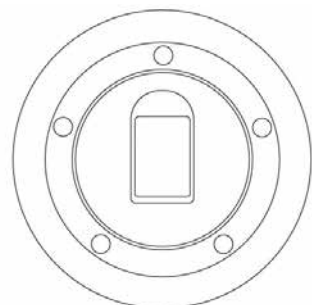

6309

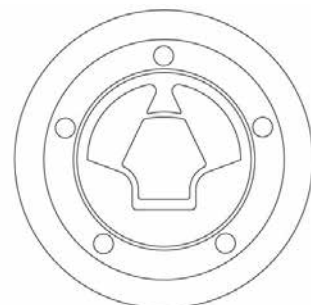

6311

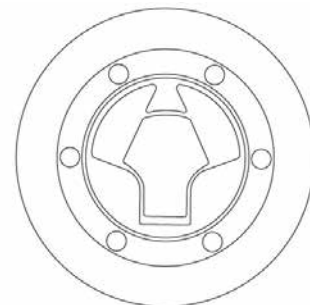

6313

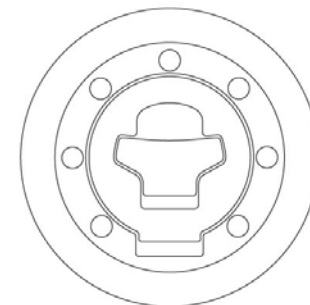

6315

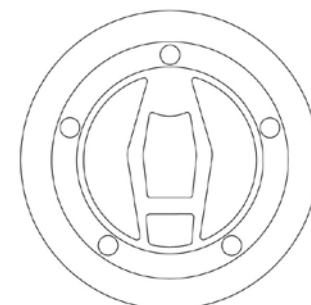

8976

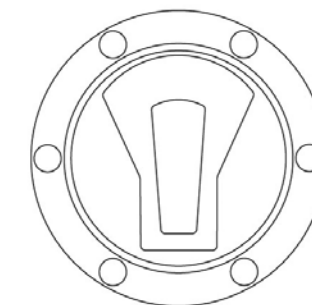

8978

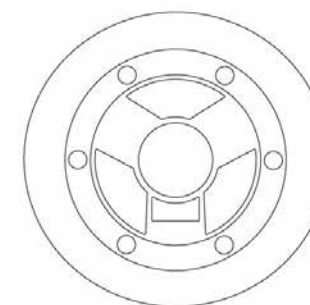

8980

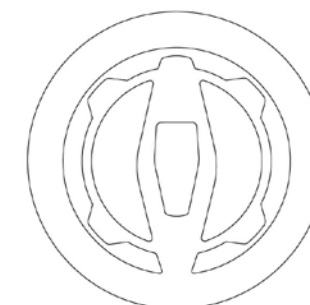

9361

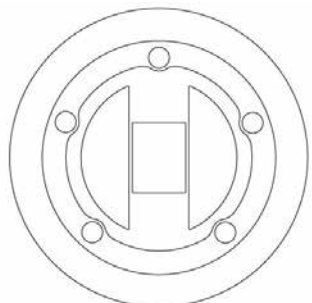

6317

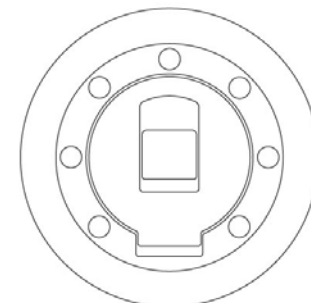

6321

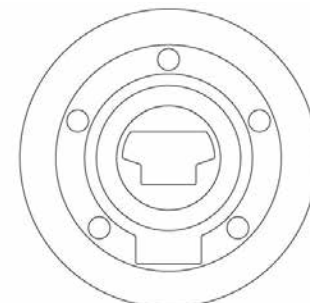

6323

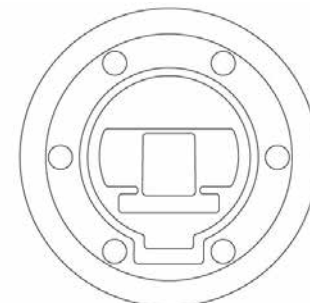

6824

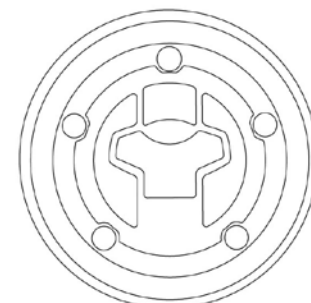

9428

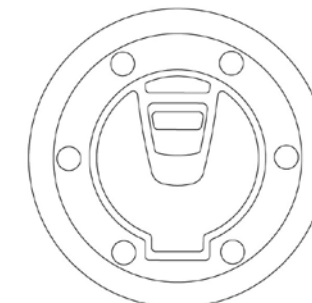

9446

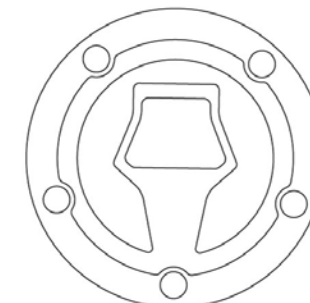

9608

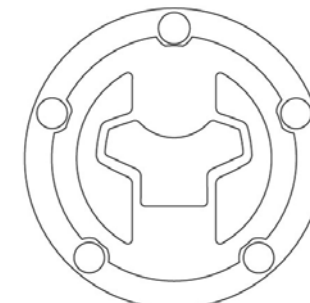

9964

IMPORTANT: We recommend verify the design of the cap with the above diagrams when ordering.

IMPORTANT: We recommend verify the design of the cap with the above diagrams when ordering.

ADHESIVE RADIKAL YOKE & TANK PADS HI-TECH PARTS



// TANK PAD

MODEL	REF.	R	V	A	U
UNIVERSAL	6292				(*)



// PLUG DEPOSIT PROTECTOR

MODEL	REF.	R	V	A	U
SPECIFIC MODELS (#)	CHECK OUR WEBSITE				(*)

(#) DRAWINGS OF ALL FUEL CAP PROTECTORS AVAILABLE SEE PAGE 294.



// YOKE PROTECTOR

MODEL	REF.	R	V	A	U
SPECIFIC MODELS	CHECK OUR WEBSITE				(*)



(*) Check price with your distributor.

Check availability for motorcycle models at www.puig.tv typing in the searching window

RADIKAL FUEL CAP COVER

HI-TECH PARTS

2021 MODELS: www.puig.tv

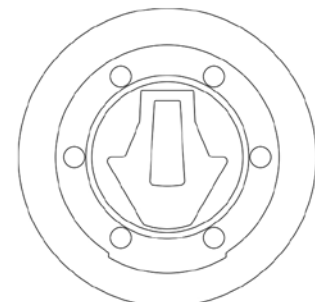

3696

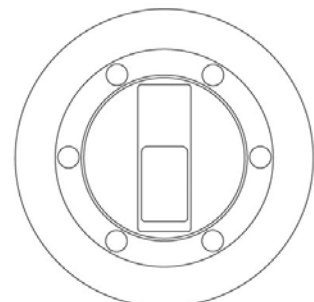

6294

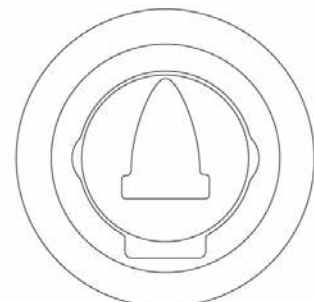

6296

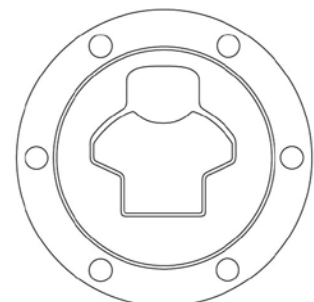

6298

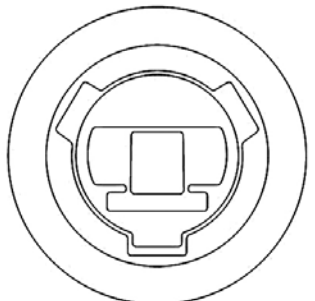

6300

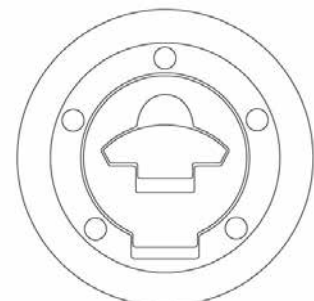

6304

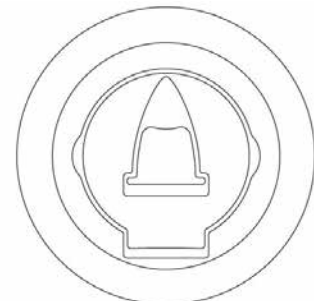

6306

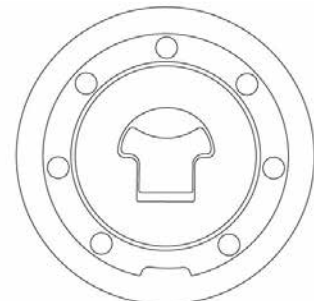

6308

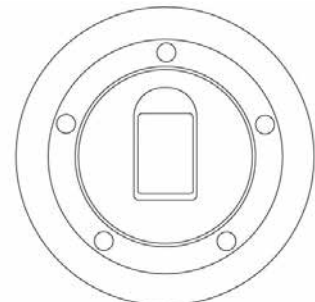

6310

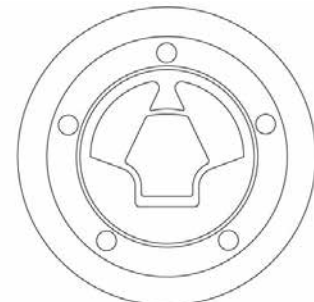

6312

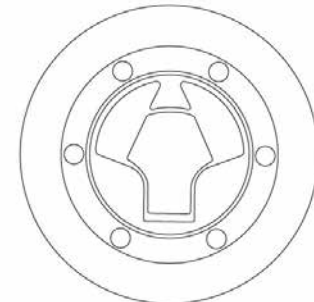

6314

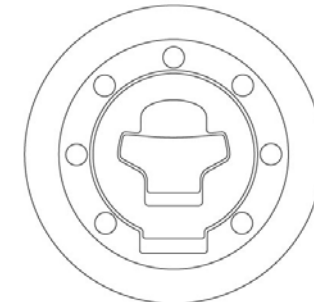

6316

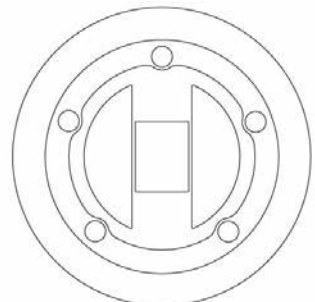

6318

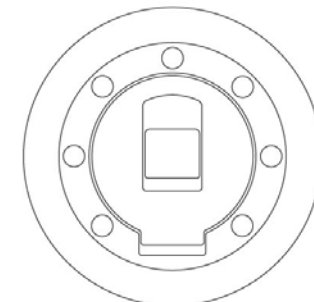

6322

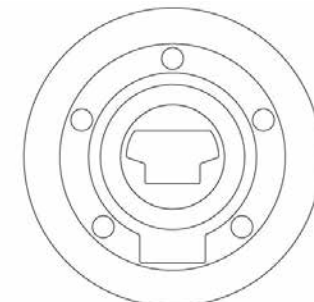

6324

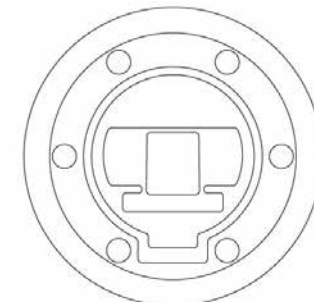

6825

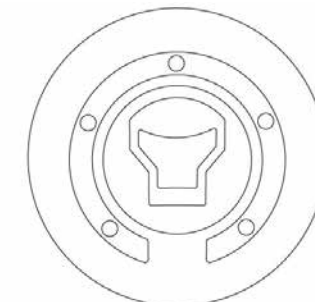

7572

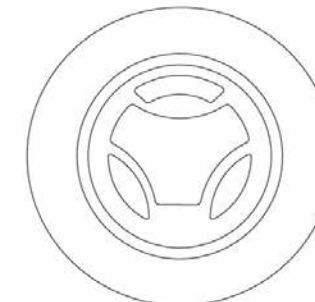

7584

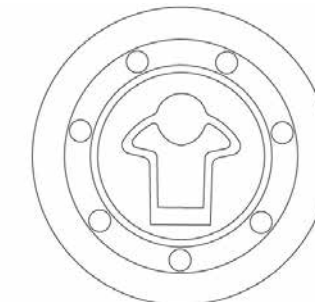

7611

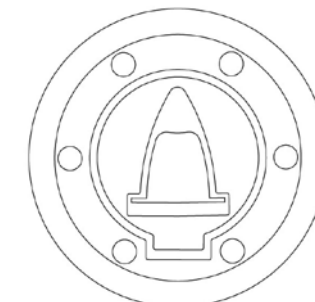

8174

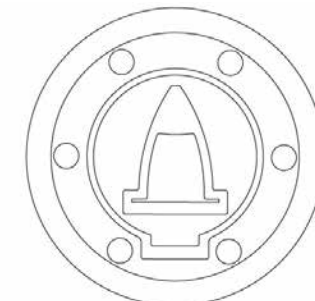

8263

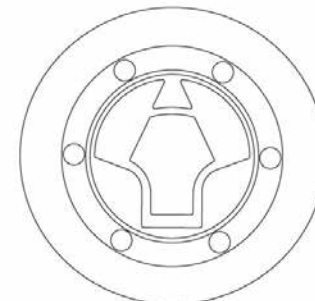

8269

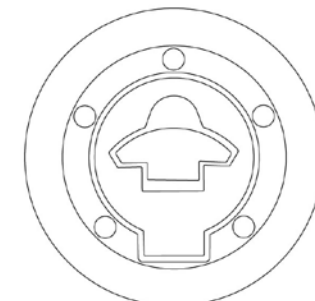

8281

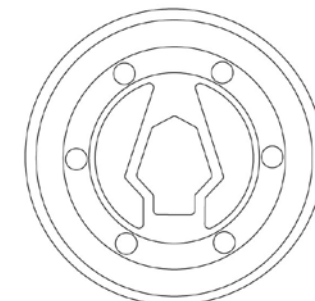

9041

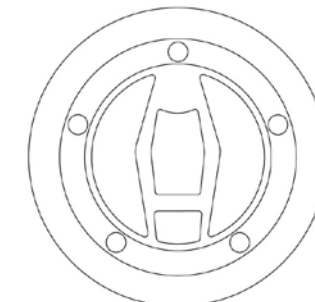

9049

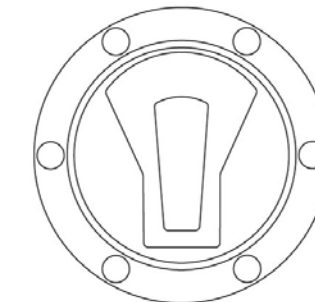

9051

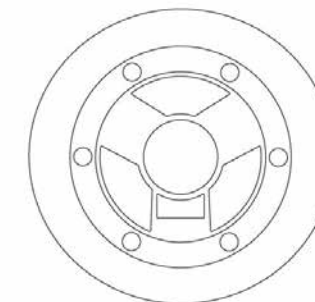

9053

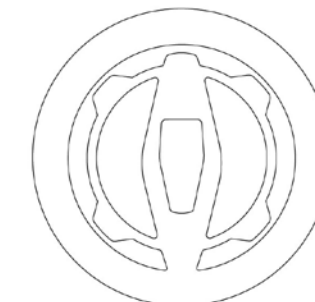

9362

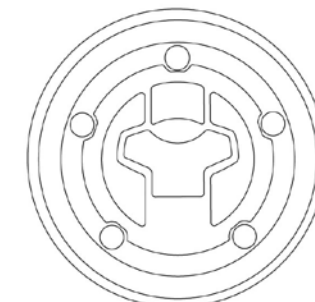

9429

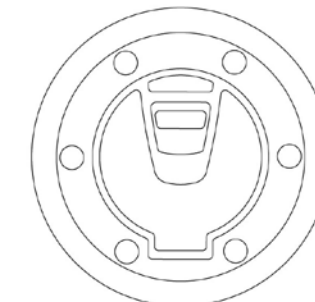

9447

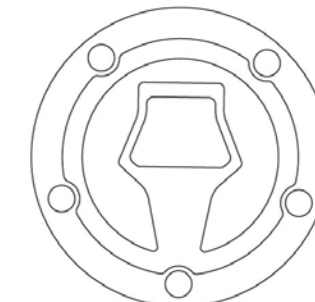

9609

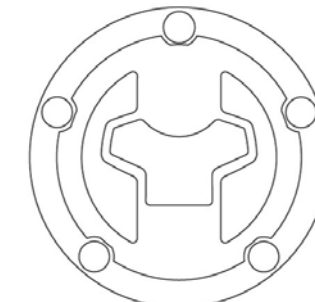

9965

IMPORTANT: We recommend verify the design of the cap with the above diagrams when ordering.

IMPORTANT: We recommend verify the design of the cap with the above diagrams when ordering.

ADHESIVE X-TREME YOKE & TANK PADS HI-TECH PARTS



// TANK PAD

MODEL	REF.	€
UNIVERSAL	7597C	(*)



// PLUG DEPOSIT PROTECTOR

MODEL	REF.	€
SPECIFIC MODELS (#)	CHECK OUR WEBSITE	(*)

(#) DRAWINGS OF ALL FUEL CAP PROTECTORS AVAILABLE SEE PAGE 298.



// YOKE PROTECTOR

MODEL	REF.	€
SPECIFIC MODELS	CHECK OUR WEBSITE	(*)



The central section of the tank pad is transparent.



(*) Check price with your distributor.

IMPORTANT: Indicate code color after part#. Example 0973A

Check availability for motorcycle models at www.puig.tv typing in the searching window



X-TREME FUEL CAP COVER

HI-TECH PARTS

2021 MODELS: www.puig.tv

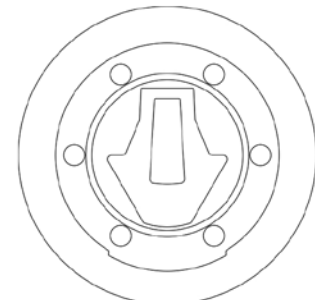

3697

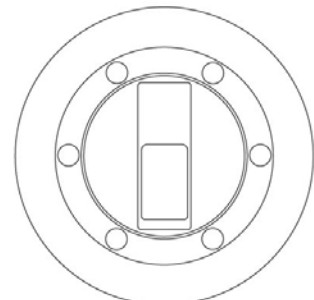

8375

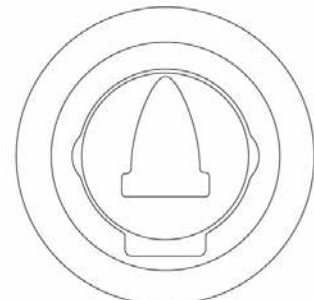

8376

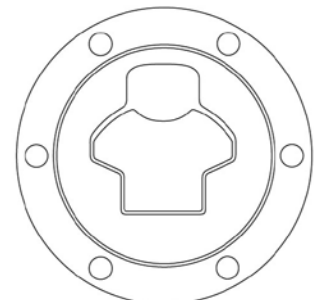

8382

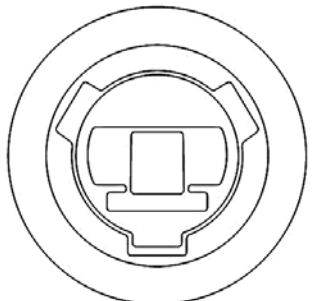

8383

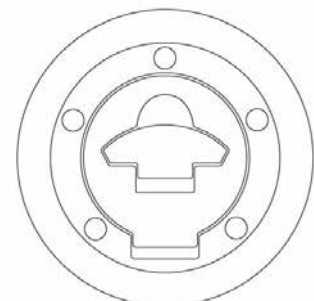

8385

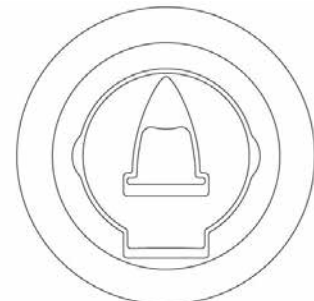

8386

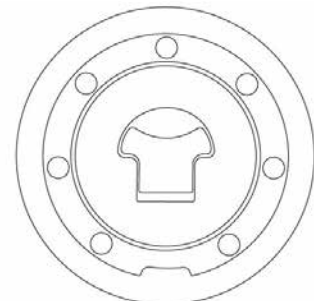

8390

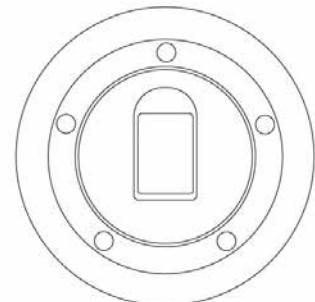

8401

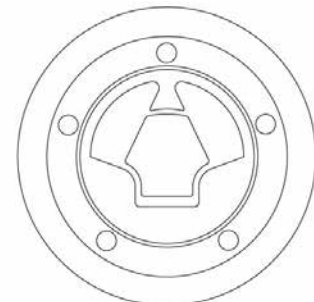

8402

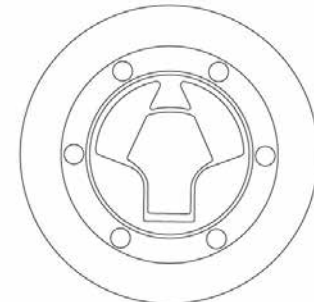

8394

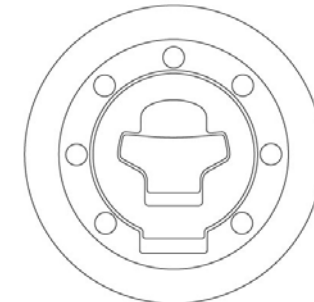

8409

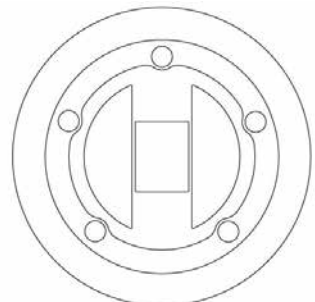

8410

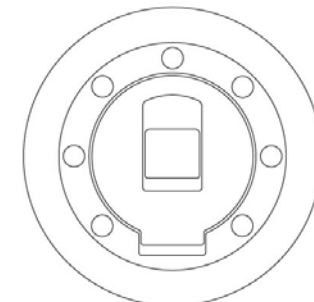

8415

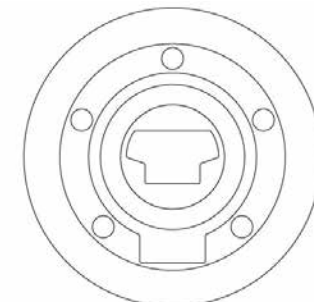

8416

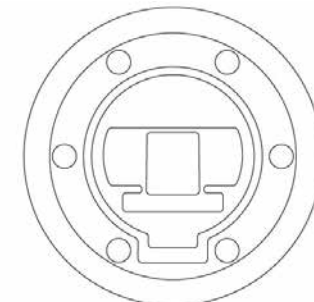

8379

2021 MODELS: www.puig.tv

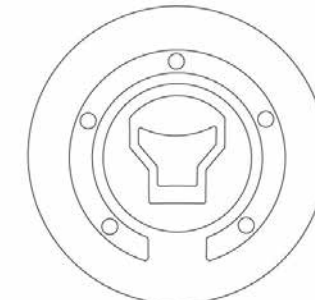

8391

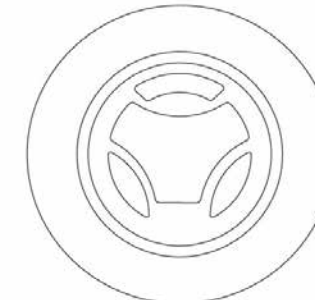

8414

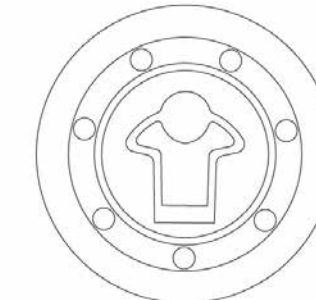

8405

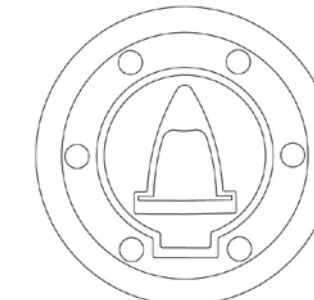

8175

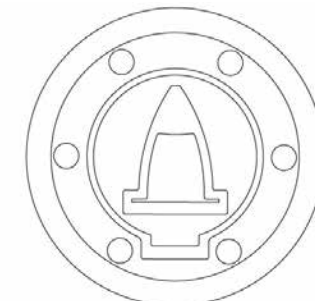

8384

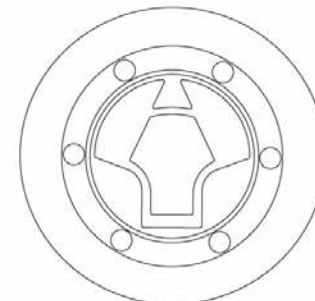

8399

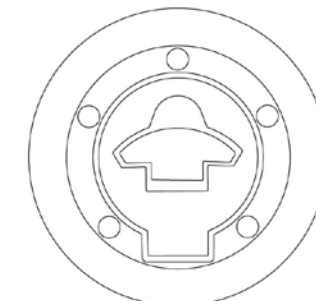

8413

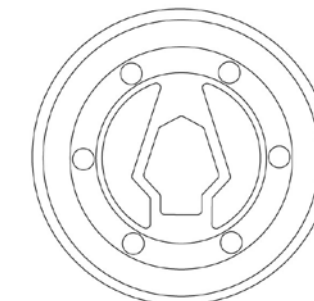

9057

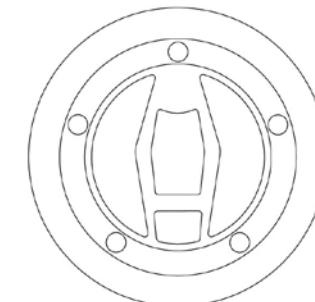

9065

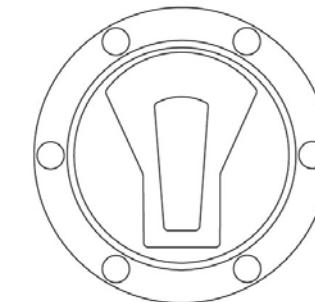

9067

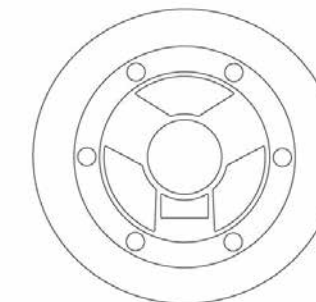

9069

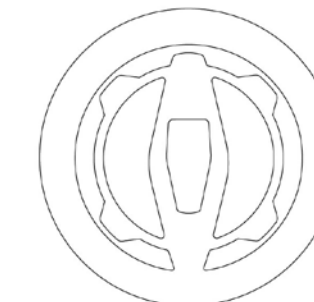

9363

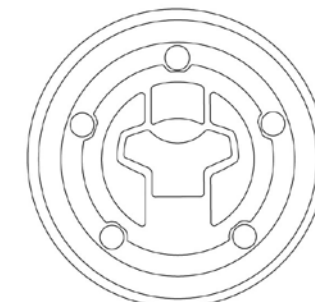

9430

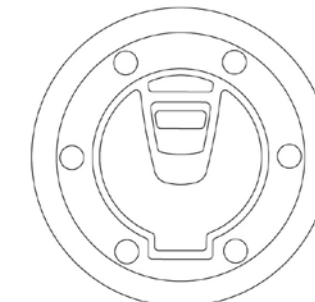

9448

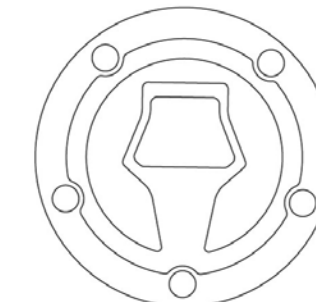

9610

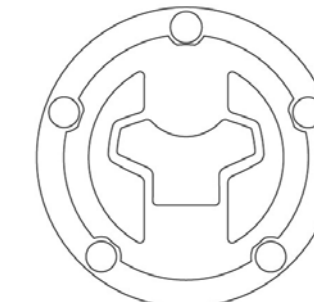

9966

IMPORTANT: We recommend verify the design of the cap with the above diagrams when ordering.

IMPORTANT: We recommend verify the design of the cap with the above diagrams when ordering.

ADHESIVE TANK PADS

HI-TECH PARTS

// FORM DESIGNED SPECIFICALLY FOR EACH MODEL MOTORCYCLE

The kit consists of three elements: The frontal protection and the two lateral ones that improve grip in turns.

2021 MODELS: www.puig.tv

MODEL	YEAR	REF.	C
BMW			
F800R	09' - 20'	8433C	(*)
F750GS	18' - 20'	3716C	(*)
F850GS	18' - 20'	3717C	(*)
F850GS ADVENTURE	19' - 20'	3718C	(*)
S1000R	14' - 20'	9130C	(*)
S1000XR	15' - 20'	3715C	(*)
R1200GS	13 - 16'	8434C	(*)
R1200GS	17' - 18'	9463C	(*)
R1200GS EXCLUSIVE	17' - 18'	9463C	(*)
R1200GS RALLYE	17' - 18'	9463C	(*)
R1250GS	18' - 20'	3719C	(*)
R1250GS HP	18' - 20'	3719C	(*)
R1250GS ADVENTURE	18' - 20'	3720C	(*)
R NINE T	14' - 20'	9129C	(*)
R NINE T SCRAMBLER	16' - 20'	9129C	(*)
R NINE T PURE	17' - 20'	9129C	(*)
R NINE T RACER	17' - 20'	9129C	(*)
R NINE T URBAN G/S	17' - 20'	9129C	(*)
DUCATI			
SCRAMBLER 1100	18' - 20'	9131C	(*)
SCRAMBLER 1100 SPORT	18' - 20'	9131C	(*)
SCRAMBLER 1100 SPECIAL	18' - 20'	9131C	(*)
SCRAMBLER ICON/CLASSIC/FULL THROTTLE	15' - 20'	9131C	(*)
SCRAMBLER SIXTY2	16' - 20'	9131C	(*)
SCRAMBLER URBAN ENDURO	15' - 16'	9131C	(*)
SCRAMBLER FLAT TRACK PRO	16'	9131C	(*)
SCRAMBLER DESERT SLED	17' - 20'	9131C	(*)
SCRAMBLER CAFE RACER	17' - 20'	9131C	(*)
HONDA			
CMX 500 REBEL	17' - 20'	3721C	(*)
CRF1000L AFRICA TWIN	16' - 19'	9303C	(*)
CRF1000L AFRICA TWIN ADVENTURE SPORTS	18' - 19'	9303C	(*)
KAWASAKI			
ER-6N	12' - 16'	9132C	(*)
Z650	17' - 20'	9297C	(*)



C

Carbon Look combined with transparent

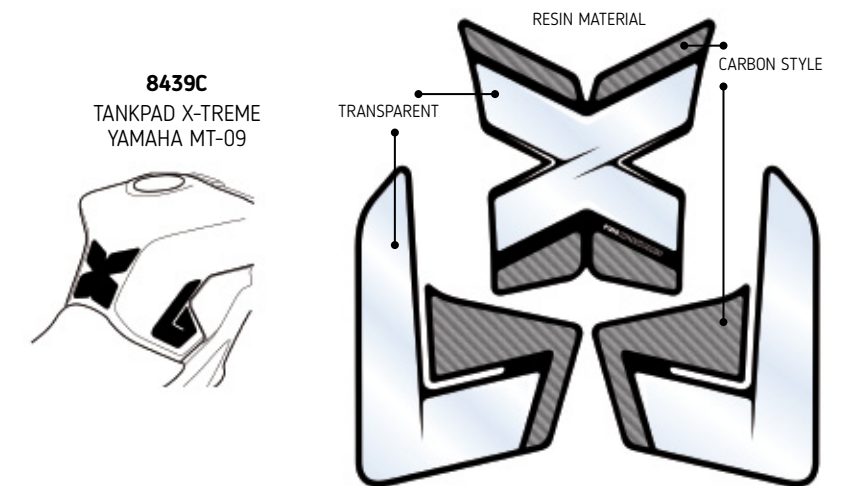

8439C
TANKPAD X-TREME
YAMAHA MT-09

2021 MODELS: www.puig.tv

MODEL	YEAR	REF.	C
Z800/E	13' - 16'	8435C	(*)
Z900	17' - 20'	9296C	(*)
Z1000	14' - 19'	8436C	(*)
KTM			
390 DUKE	17 - 20'	3722C	(*)
790 DUKE	18' - 20'	3723C	(*)
1290 SUPERDUKE R	14' - 20'	9298C	(*)
SUZUKI			
GSR750	11' - 16'	8437C	(*)
GSX-S750	17' - 20'	9295C	(*)
YAMAHA			
MT-07	14' - 20'	8438C	(*)
MT-07 TRACER	16' - 20'	9301C	(*)
MT-07 TRACER GT	19'	9301C	(*)
MT-09	13' - 20'	8439C	(*)
MT-09 SP	18' - 20'	8439C	(*)
MT-09 TRACER	15' - 20'	9302C	(*)
MT-09 TRACER GT	18' - 20'	9302C	(*)
MT-10	16' - 20'	9294C	(*)
MT-10 SP	17' - 20'	9294C	(*)
XSR700	16' - 20'	9300C	(*)
XSR700 XTRIBUTE	19' - 20'	9300C	(*)
XSR900	16' - 20'	9299C	(*)



(*) Check price with your distributor.

IMPORTANT: Indicate code color after part#. Example 0973A

TANK SIDE PROTECTORS ANTI-SLIP

HI-TECH PARTS | TECHNICAL SECTION



REF. 20060N



EASY MOUNTING
PROCESS



ANTI-SCRATCH



IMPROVE
GRIP

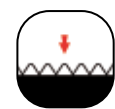

SOFT RUBBER
FEEL

REF. 20060W



N
Black

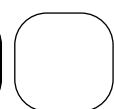

W
Transparent



TANK SIDE PROTECTORS ANTI-SLIP

HI-TECH PARTS

2021 MODELS: www.puig.tv				
MODEL	YEAR	REF.	 	
APRILIA				
RSV4	09' - 12'	20060	(*)	
RSV4 FACTORY	09' - 15'	20060	(*)	
RSV4 R	13' - 14'	20060	(*)	
RSV4 RF/RR	15' - 20'	20060	(*)	
TUONO V4R	11' - 14'	20060	(*)	
BMW				
R1200 GS	04' - 12'	20061	(*)	
R1200 GS	13' - 18'	20062	(*)	
R1200 GS RALLYE	17' - 18'	20062	(*)	
R1200 GS EXCLUSIVE	17' - 18'	20062	(*)	
R1200 GS ADVENTURE	06' - 13'	20061	(*)	
R1200GS ADVENTURE	14' - 18'	20063	(*)	
R1200 RS	14' - 19'	20064	(*)	
S1000 R	09' - 20'	20065	(*)	
S1000 RR	09' - 18'	20065	(*)	
S1000 RR	19' - 20'	20290	(*)	
DUCATI				
899 PANIGALE	14' - 15'	20066	(*)	
959 PANIGALE	16' - 20'	20066	(*)	
1199 PANIGALE	12' - 14'	20066	(*)	
1299 PANIGALE/S	15' - 17'	20066	(*)	
PANIGALE 1100 V4	18' - 20'	20067	(*)	
PANIGALE 1100 V4 S	18' - 20'	20067	(*)	
MONSTER 797	17' - 20'	20068	(*)	
MONSTER 821	14' - 20'	20068	(*)	
MONSTER 1200/S	14' - 20'	20068	(*)	
MONSTER 1200 R	16' - 20'	20068	(*)	
MULTISTRADA 950	17' - 20'	20291	(*)	
MULTISTRADA 1200/ S	15' - 17'	20069	(*)	
MULTISTRADA 1200 ENDURO/PRO	16' - 20'	20070	(*)	
MULTISTRADA 1200 PIKES PEAK	16' - 17'	20069	(*)	
MULTISTRADA 1260/S/S D'AJAIR	18' - 20'	20069	(*)	

2021 MODELS: www.puig.tv				
MODEL	YEAR	REF.	 	
MULTISTRADA 1260 PIKES PEAK	18' - 20'	20069	(*)	
MULTISTRADA 1260 ENDURO	18' - 20'	20070	(*)	
SCRAMBLER ICON/CLASSIC/FULL THROTTLE	15' - 20'	20071	(*)	
SCRAMBLER SIXTY2	16' - 20'	20071	(*)	
SCRAMBLER URBAN ENDURO	15' - 16'	20071	(*)	
SCRAMBLER FLAT TRACK PRO	16'	20071	(*)	
SCRAMBLER DESERT SLED	17' - 20'	20071	(*)	
SCRAMBLER CAFE RACER	17' - 20'	20071	(*)	
SCRAMBLER 1100	15' - 20'	20071	(*)	
SCRAMBLER 1100 SPORT	15' - 20'	20071	(*)	
SCRAMBLER 1100 SPECIAL	15' - 20'	20071	(*)	
HONDA				
CBR600RR	13' - 16'	20072	(*)	
CBR650R	19' - 20'	20469	(*)	
CBR1000RR FIREBLADE/SP	12' - 16'	20073	(*)	
CBR1000RR FIREBLADE/SP/SP2	17' - 20'	20074	(*)	
CRF1000L AFRICA TWIN	16' - 19'	20075	(*)	
CRF1000L AFRICA TWIN ADVENTURE SPORTS	18' - 19'	20075	(*)	
CRF1100L AFRICA TWIN	20'	20487	(*)	
CRF1100L AFRICA TWIN ADVENTURE SPORTS	20'	20487	(*)	
KAWASAKI				
NINJA 400	18' - 20'	20076	(*)	
NINJA 650	17' - 19'	20080	(*)	
VERSYS 1000	15' - 20'	20077	(*)	
Z900	17' - 20'	20078	(*)	
Z1000	18' - 20'	20079	(*)	
Z1000SX	11' - 20'	20079	(*)	
ZX-6R	09' - 16'	20080	(*)	
ZX-6R 636	09' - 16'	20080	(*)	
ZX-10R	11' - 20'	20081	(*)	
KTM				
690 DUKE	08' - 11'	20171	(*)	
1050 ADVENTURE	15' - 16'	20171	(*)	

2021 MODELS: www.puig.tv				
MODEL	YEAR	REF.	 	
1090 ADVENTURE /R	17' - 20'	20171	(*)	
1190 ADVENTURE /R	13' - 16'	20171	(*)	
1290 SUPER ADVENTURE	15' - 16'	20171	(*)	
1290 SUPER ADVENTURE R	17' - 20'	20171	(*)	
1290 SUPER ADVENTURE S	17' - 20'	20171	(*)	
1290 SUPER ADVENTURE T	17' - 20'	20171	(*)	
SUZUKI				
DL1000 V-STROM	14' - 20'	20082	(*)	
DL1000XT V-STROM	17' - 20'	20082	(*)	
GSX-R600	11' - 16'	20083	(*)	
GSX-R750	11' - 16'	20083	(*)	
GSX-R1000/R	17' - 20'	20084	(*)	
GSX-S750	17' - 20'	20085	(*)	
GSX-S1000	15' - 20'	20086	(*)	
GSX-S1000F	16' - 20'	20086	(*)	
TRIUMPH				
DAYTONA 675	13' - 17'	20087	(*)	
DAYTONA 675 R	13' - 17'	20087	(*)	
STREET TRIPLE	13' - 19'	20087	(*)	
STREET TRIPLE R	13' - 19'	20087	(*)	
STREET TRIPLE S/RS	17' - 19'	20087	(*)	
TIGER EXPLORER XC/XR/XRX/XRT/XCX/XCA	16' - 20'	20088	(*)	
YAMAHA				
MT-07	18' - 20'	20089	(*)	
MT-09	13' - 20'	20090	(*)	
MT-09 SP	18' - 20'	20090	(*)	
MT-09 TRACER	15' - 20'	20091	(*)	
MT-09 TRACER GT	18' - 20'	20091	(*)	
MT-10	16' - 20'	20092	(*)	
MT-10 SP	17' - 20'	20092	(*)	
XT1200Z SUPER TÉNÉRÉ	12' - 20'	20093	(*)	
YZF-R1	15' - 20'	20094	(*)	
YZF-R1M	17' - 20'	20094	(*)	

2021 MODELS: www.puig.tv				
MODEL	YEAR	REF.	 	
YZF-R3	19' - 20'	20292	(*)	
YZF-R6	08' - 16'	20095	(*)	
YZF-R6	17' - 20'	20096	(*)	
FIXATIVE PROMOTER KIT		20220N	(*)	

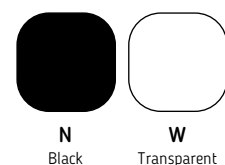

(*) Check price with your distributor.
IMPORTANT: Indicate code color after part#. Example: 0973A

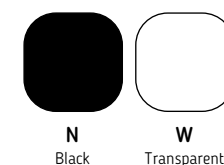

(*) Check price with your distributor.
IMPORTANT: Indicate code color after part#. Example: 0973A

DREI TANK PADS HI-TECH PARTS



MODEL	REF.	PRICE
DREI CARBON LOOK	3075C	(*)
DREI TRANSPARENT	3075W	(*)

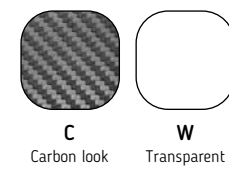

(*) Check price with your distributor.
IMPORTANT: Indicate code color after part#. Example 0973A

PERFORMANCE TANK PADS HI-TECH PARTS



MODEL	REF.	PRICE
PERFORMANCE CARBON LOOK	4051C	(*)
PERFORMANCE TRANSPARENT	4051W	(*)
PERFORMANCE SILVER	4051P	(*)
PERFORMANCE GREY	4051U	(*)
50° ANNIVERSARY	7427C	(*)

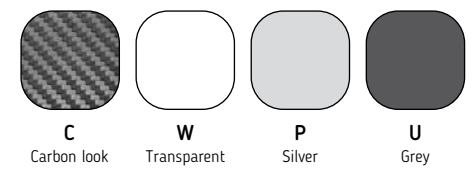

(*) Check price with your distributor.
IMPORTANT: Indicate code color after part#. Example 0973A

PERFORMANCE 2 TANK PADS
HI-TECH PARTS

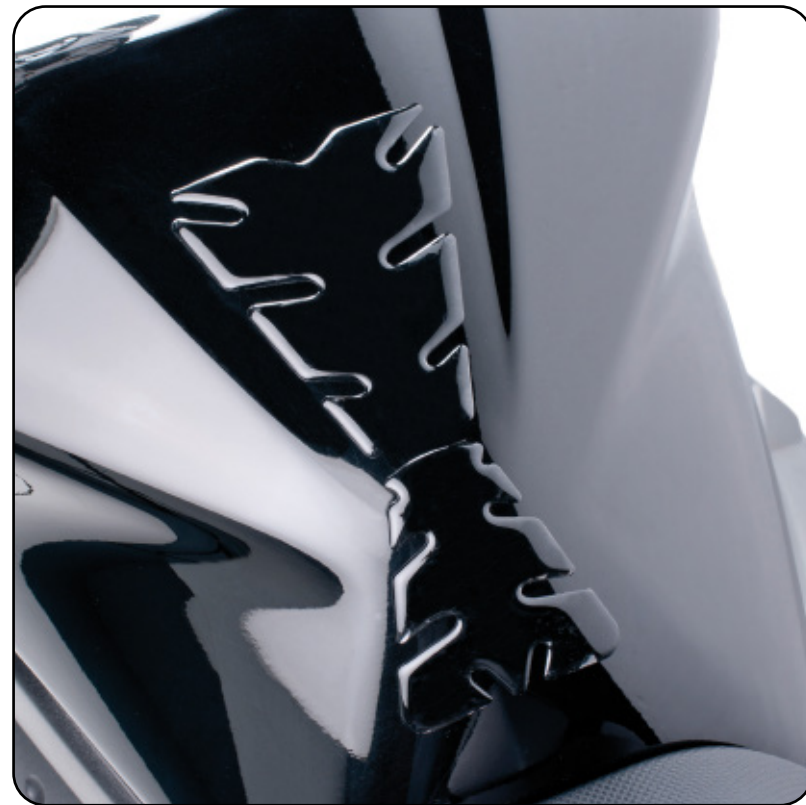

MODEL	REF.	PRICE
PERFORMANCE 2 CARBON LOOK	5876C	(*)
PERFORMANCE 2 TRANSPARENT	5876W	(*)

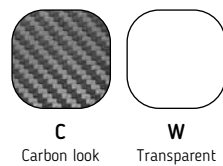

(*) Check price with your distributor.
IMPORTANT: Indicate code color after part#. Example 0973A

TANK PADS
HI-TECH PARTS



// TIRE

MODEL	REF.	PRICE
TIRE BLACK	9939N	(*)
TIRE TRANSPARENT	9939W	(*)

// LEATHER

MODEL	REF.	PRICE
LEATHER GREY	9304U	(*)
LEATHER BROWN	9304F	(*)
LEATHER BLACK	9304N	(*)
LEATHER CARBON LOOK	9304C	(*)

// SOFT

MODEL	REF.	PRICE
SOFT CARBON LOOK	8432C	(*)
SOFT WHITE	8432B	(*)

Because of its width might not get properly fit on tanks with pronounced curves.

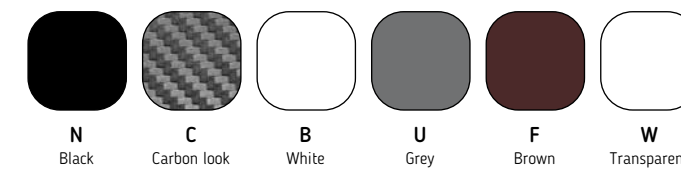

(*) Check price with your distributor.
IMPORTANT: Indicate code color after part#. Example 0973A

WINGS TANK PADS

HI-TECH PARTS



MODEL	REFERENCE	PRICE
BMW (1)	4718N	(*)
DUCATI (2)	4719R	(*)
HONDA (3)	4785P	(*)
HONDA (4)	4785R	(*)
CBR (5)	4784A	(*)
CBR (6)	4784P	(*)
CBR (7)	4784R	(*)
KAWASAKI (8)	4720N	(*)
KAWASAKI (9)	4720V	(*)
NINJA (10)	4721V	(*)
NINJA (11)	4721R	(*)
SUZUKI (12)	4724A	(*)
YAMAHA (13)	4722A	(*)
YAMAHA (14)	4722R	(*)
YZF (15)	4723A	(*)
YZF (16)	4723R	(*)
YZF (17)	4723P	(*)

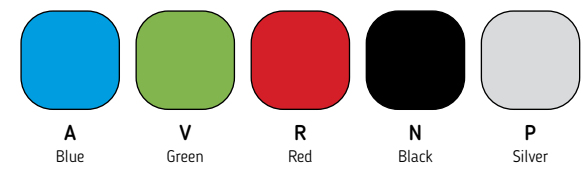

(*) Check price with your distributor.
IMPORTANT: Indicate code color after part#. Example 0973A

SPIRIT TANK PADS

HI-TECH PARTS



MODEL	REF.	N	P
CBF	4725		(*)
HORNET	4228		(*)
NC	9142		(*)
REBEL	20483		(*)
HYOSUNG			
GT650	4729		(*)
KAWASAKI			
ER6F	5112		(*)
ER6N	4327		(*)
NINJA	4221		(*)
VULCAN S	20485		(*)
Z650	9306		(*)
Z750	4328		(*)
Z800	7484		(*)
Z900	9307		(*)
Z1000	4479		(*)
KTM			
ADVENTURE	20482		(*)
DUKE	20480		(*)
SUZUKI			
BANDIT	4226		(*)
GLADIUS	5109		(*)
GSR	4329		(*)
SDXR	4222		(*)
SV	4225		(*)
TRIUMPH			
DAYTONA	4730		(*)
YAMAHA			
FZ	4227		(*)
FAZER	4341		(*)
R6	4220		(*)
R1	4219		(*)
XJ6	5110		(*)
MT	9143		(*)
XSR	9308		(*)
TENERE	20481		(*)
UNIVERSAL			
RACING	4224		(*)

MODEL	REF.	N	P
APRILIA			
RSV1000	4727		(*)
SHIVER	5111		(*)
DUCATI			
1098	4728		(*)
MONSTER	4726		(*)
MONSTER 696	5108		(*)
HONDA			
AFRICA TWIN	20484		(*)
CBR	4223		(*)

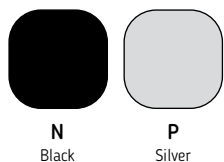

(*) Check price with your distributor.
 IMPORTANT: Indicate code color after part#. Example: 0973A

TANK PADS
HI-TECH PARTS



// FUTURE

MODEL	REF.	PRICE
APRILIA	5631N	(*)
BMW	6460P	(*)
DUCATI	5633R	(*)
HONDA	5634R	(*)
KAWASAKI (1)	5630P	(*)
KAWASAKI (2)	5630V	(*)
SUZUKI	5632A	(*)
YAMAHA	5635P	(*)



// VIOLENT

MODEL	REF.	PRICE
VIOLENT BLUE	5519A	(*)
VIOLENT CARBON LOOK	5519C	(*)
VIOLENT BLACK	5519N	(*)
VIOLENT RED	5519R	(*)
VIOLENT GREEN	5519V	(*)
VIOLENT TRANSPARENT	5519W	(*)

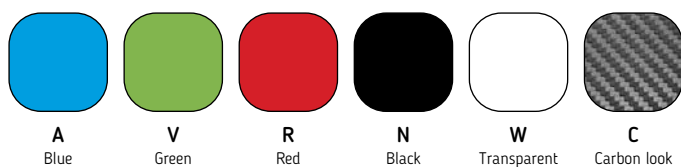

(*) Check price with your distributor.
IMPORTANT: Indicate code color after part#. Example 0973A



// SPIRIT II

MODEL	REF.	PRICE
SPIRIT II BLUE	9140A	(*)
SPIRIT II ORANGE	9140T	(*)
SPIRIT II GREEN	9140V	(*)



// ONE

MODEL	REF.	PRICE
ONE BLUE	9141A	(*)
ONE RED	9141R	(*)
ONE GREEN	9141V	(*)

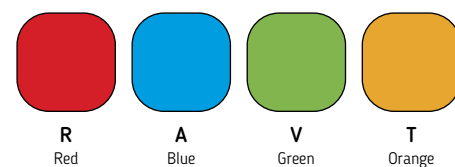

(*) Check price with your distributor.
IMPORTANT: Indicate code color after part#. Example 0973A

TANK PADS
HI-TECH PARTS



// MOON

MODEL	REF.	PRICE
MOON RED (1)	9139R	(*)
MOON SILVER (2)	9139P	(*)
MOON ORANGE (3)	9139T	(*)

// SCREAM

MODEL	REF.	PRICE
SCREAM BLACK	9602N	(*)

// JOKER

MODEL	REF.	PRICE
JOKER GREY	6496U	(*)
JOKER GREEN	6496V	(*)
JOKER BLUE	6496A	(*)

// CLOWN

MODEL	REF.	PRICE
CLOWN GREY	9305U	(*)
CLOWN GREEN	9305V	(*)
CLOWN BLUE	9305A	(*)

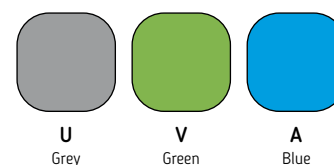
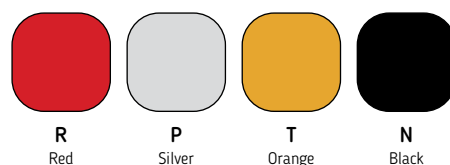

(*) Check price with your distributor.
IMPORTANT: Indicate code color after part#. Example 0973A

(*) Check price with your distributor.
IMPORTANT: Indicate code color after part#. Example 0973A

TANK PADS
HI-TECH PARTS



// MINI

MODEL	REF.	PRICE
MINI CARBON LOOK	2560C	(*)

// ARROW

MODEL	REF.	PRICE
ARROW CARBON LOOK	2774C	(*)

// WAY

MODEL	REF.	PRICE
WAY BLACK	4478N	(*)
WAY CARBON LOOK	4478C	(*)

// SUN

MODEL	REF.	PRICE
SUN CARBON LOOK	4512C	(*)
SUN TRANSPARENT	4512W	(*)

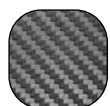

C
Carbon look

(*) Check price with your distributor.
IMPORTANT: Indicate code color after part#. Example 0973A



N Black W Transparent C Carbon look

(*) Check price with your distributor.
IMPORTANT: Indicate code color after part#. Example 0973A

TANK PADS
HI-TECH PARTS



// SKULL

MODEL	REF.	PRICE
SKULL RED	3673R	(*)
SKULL GREEN	3673V	(*)
SKULL BLUE	3673A	(*)

// SKULL I

MODEL	REF.	PRICE
SKULL I	3674R	(*)

// COLOURY

MODEL	REF.	PRICE
COLOURY	3675R	(*)

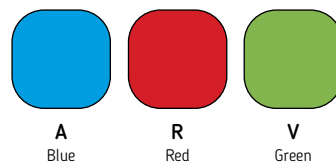

A Blue R Red V Green

(*) Check price with your distributor.
IMPORTANT: Indicate code color after part#. Example 0973A

SHEETS
HI-TECH PARTS

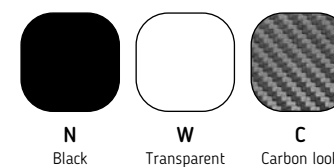
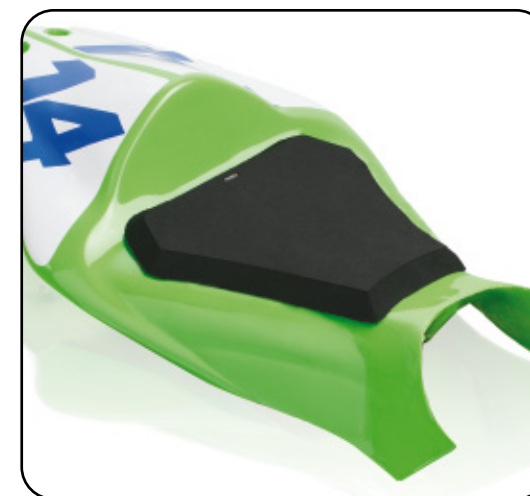

N Black W Transparent C Carbon look

// BUMPS-SHEET

MODEL	REF.	PRICE
1 SHEET COLOUR CARBON LOOK 250 x 350 mm.	4557C	(*)
1 SHEET COLOUR TRANSPARENT 250 x 350 mm.	4558W	(*)

GRIPPING ADHESIVE SHEET, DEVELOPED TO PROTECT CERTAIN PARTS FROM BEING SCRATCHED, AND TO IMPROVE THE GRIP OF THE RIDER.
SHEET SIZE: 250 x 350 mm.

// FLAT SHEET

MODEL	REF.	PRICE
1 SHEET COLOUR CARBON	4556C	(*)

SHEET SIZE: 320 x 460 mm.

// GRIPPING PADS

MODEL	REF.	PRICE
GRIPPING PADS 170 x 93,5 mm.	9310N	(*)

// ADHESIVE FOAM SEAT

MODEL	REF.	PRICE
SHORT ADHESIVE FOAM SET - AxBxC (314 x 312 x 20 mm.)	5212N	(*)
LONG ADHESIVE FOAM SET - AxBxC (344 x 312 x 20 mm.)	5213N	(*)

(*) Check price with your distributor.
IMPORTANT: Indicate code color after part#. Example 0973A

SCRATCH PADS PROTECTOR

HI-TECH PARTS

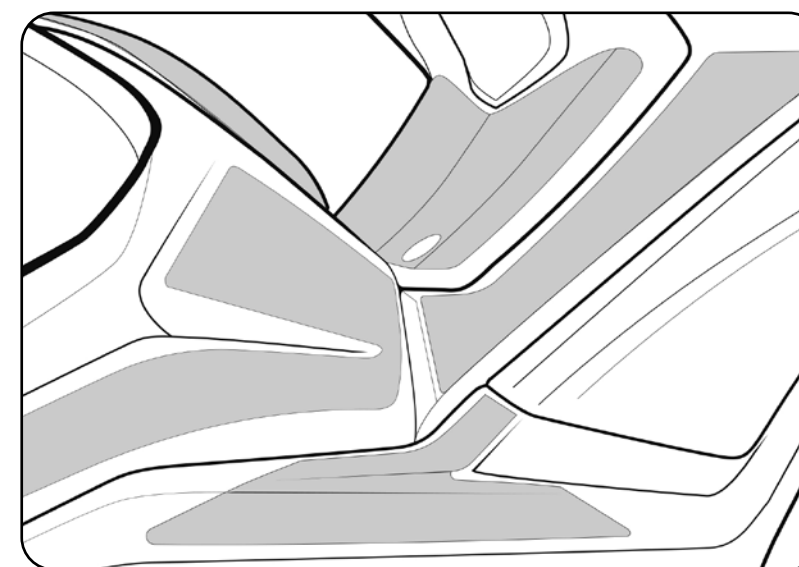

// SPECIFIC DESIGN FOR EACH MODEL OF MAXISCOOTER

Protects from scratches of getting on/off the bike, as well as embellishes the plastic without altering the graphics of the Maxiscooter.

2021 MODELS: www.puig.tv

MODEL	YEAR	REF.	N
BMW			
C650GT	16' - 20'	9951	(*)
HONDA			
X-ADV	17' - 20'	9952	(*)
KYMCO			
AK550	17' - 20'	9953	(*)
YAMAHA			
T-MAX 530/SX/DX	17' - 19'	9954	(*)
T-MAX 560 /SX/DX/MAX TECH	20'	9954	(*)

(*) Check price with your distributor.

IMPORTANT: Indicate code color after part#. Example 0973A



N
Black

KYMCO AK550 TANKPAD SCOOTER SCRATCH SAVER

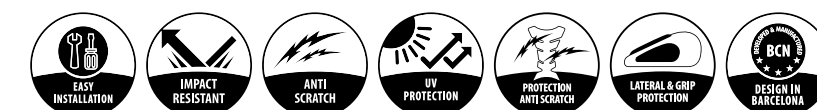
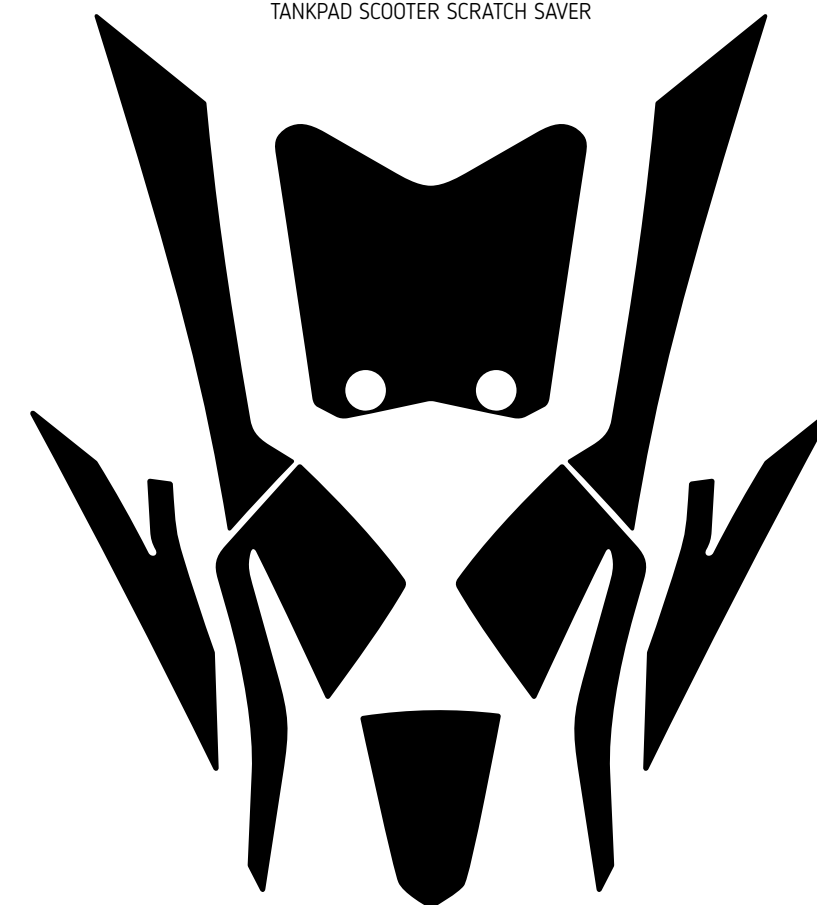

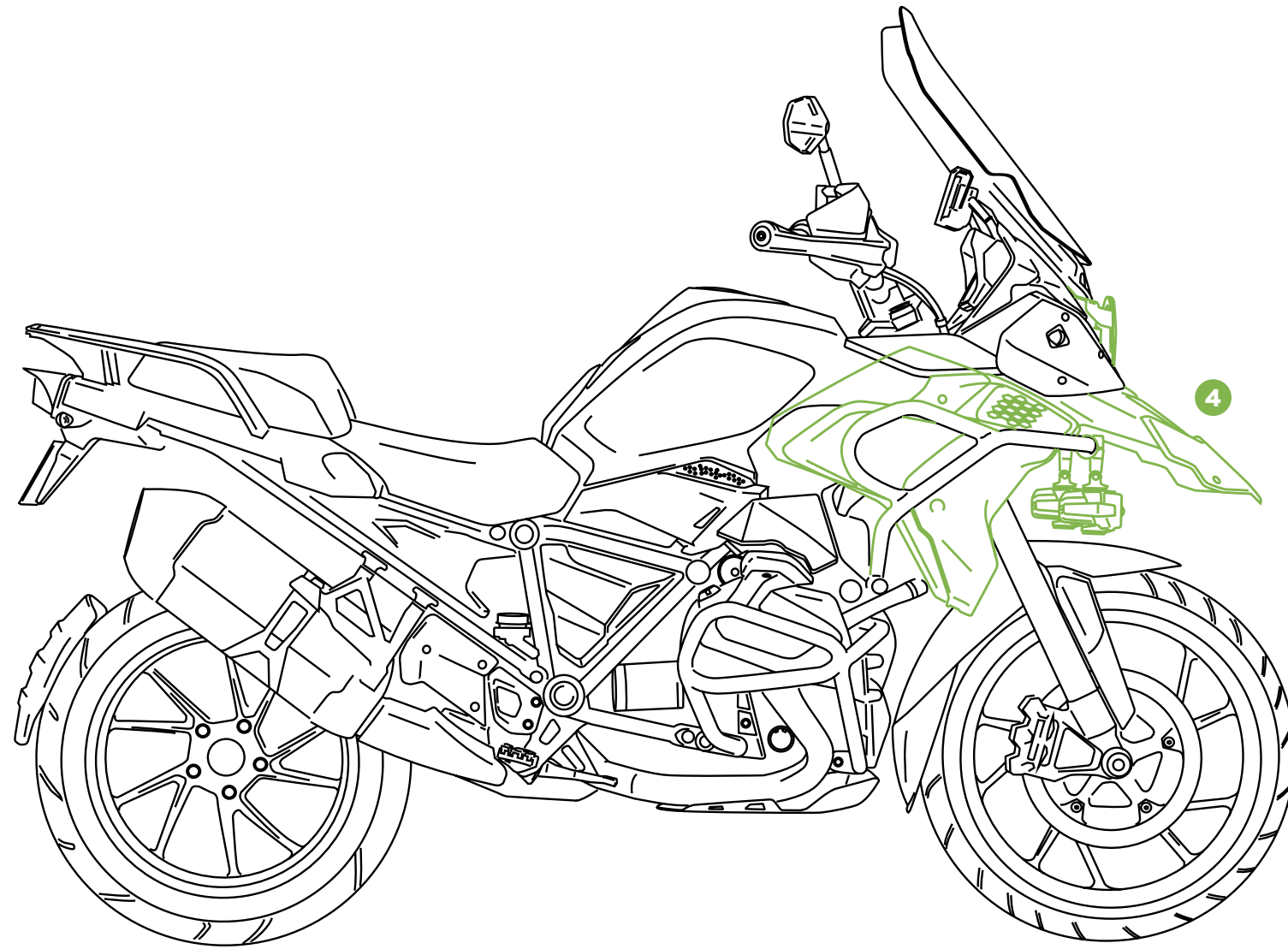

MIDDLE FRONT AREA

AUXILIARY LIGHTS	333
CONNECTORS LEADS	366
FORK PROTECTOR	331
BEAK EXTENDER	327
HEADLIGHT PROTECTOR	337
INTEGRATED TURN SIGNALS	368
LIGHTS	339
LOWER DEFLECTORS	331
RADIATOR SIDE PANELS	329
RESISTOR SET FOR LEDS TURN SIGNALS AND FLASHER RELAYS	365
SEQUENTIAL TURN SIGNALS	347
SUPPORTS AUXILIARY LIGHTS	335
TURN SIGNAL COVERS	341
TURN SIGNALS	348

BEAK EXTENDER

HI-TECH PARTS | TECHNICAL SECTION

REF. 9174J

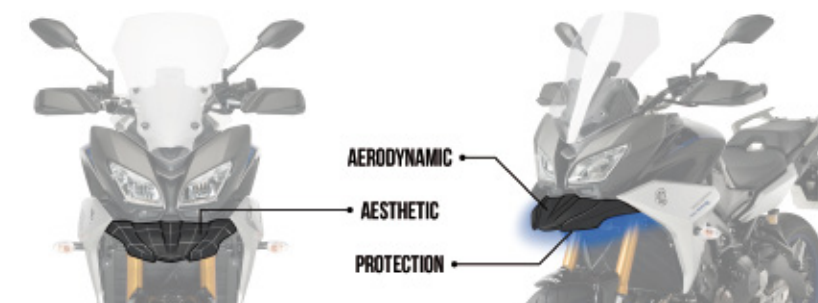

2021 MODELS: www.puig.tv

MODEL	YEAR	REF.	ⓐ
BMW			
F900XR	20'	20393	(*)
R1200GS	13' - 16'	9174	(*)
R1200GS	17' - 18'	9473	(*)
R1200GS EXCLUSIVE	17' - 18'	9473	(*)
R1200GS RALLYE	17' - 18'	9473	(*)
R1250GS	18' - 20'	9473	(*)
R1250GS HP	18' - 20'	9473	(*)



J
Matt black

2021 MODELS: www.puig.tv

MODEL	YEAR	REF.	ⓐ
HONDA			
CRF1000L AFRICA TWIN	16' - 19'	3583	(*)
CRF1000L AFRICA TWIN ADVENTURE SPORTS	18' - 19'	3583	(*)
CRF1100L AFRICA TWIN	20'	3887	(*)
CRF1100L AFRICA TWIN ADVENTURE SPORTS	20'	3887	(*)
KTM			
1290 SUPER ADVENTURE R/S	17' - 20'	3662J	(*)
1290 SUPER ADVENTURE T	17'	3662J	(*)
YAMAHA			
MT-07	18' - 20'	3480	(*)
MT-07 TRACER	16' - 18'	3481	(*)
MT-09	17' - 20'	3482	(*)
MT-09 SP	18' - 20'	3482	(*)
MT-09 TRACER/GT	18' - 20'	3483	(*)
TENERE 700	19' - 20'	3806	(*)
XT1200Z SUPER TÉNÉRÉ	14' - 20'	3584	(*)

(*) Check price with your distributor.

IMPORTANT: Indicate code color after part#. Example 0973A

RADIATOR SIDE PANELS

HI-TECH PARTS | TECHNICAL SECTION



PROTECTION

Protects the rider from inclement weather.

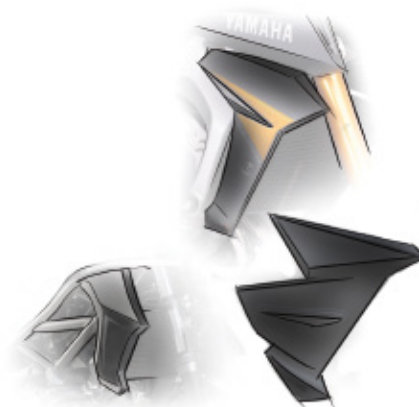

They cover the radiator's side edges and provide a continuous air flow around the rider's legs.

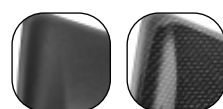

J
Matt black

C
Carbon look



REF. 6880J

2021 MODELS: www.puig.tv

MODEL	YEAR	ADHESIVE KIT	REF.	J	C
KAWASAKI					
Z650	17' - 19'	INCLUDED	9371	(*)	(*)
SUZUKI					
SV650	16' - 20'	INCLUDED	8564	(*)	(*)
YAMAHA					
MT-07	14' - 17'	INCLUDED	7561	(*)	(*)
MT-07	18' - 20'	NOT INCLUDED	9730	(*)	(*)
MT-09	13'-16'	INCLUDED	6880	(*)	(*)
MT-09	17'-20'	INCLUDED	9378	(*)	(*)
MT-09 SP	18' - 20'	INCLUDED	9378	(*)	(*)

(*) Check price with your distributor.
IMPORTANT: Indicate code color after part#. Example 0973A

LOWER DEFLECTORS
HI-TECH PARTS | TECHNICAL SECTION



REF. 9848H

// LOWER DEFLECTORS

MODEL	YEAR	REF.	W	H	F
BMW					
R1200GS	13' - 18'	9848			(*)
R1200GS EXCLUSIVE	17' - 18'	9848			(*)
R1200GS RALLYE	17' - 18'	9848			(*)
R1250GS	18' - 20'	9848			(*)

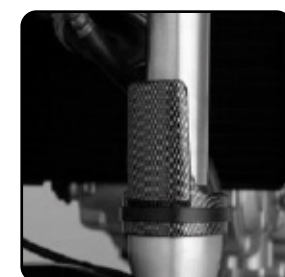

REF. 1320C

// FORK PROTECTOR

MODEL	REF.	C
UNIVERSAL BY PAIR C/CARBON LOOK	1320C	(*)



W Transparent H Smoke F Dark Smoke C Carbon look

(*) Check price with your distributor.
IMPORTANT: Indicate code color after part#. Example 0973A

AUXILIARY LIGHTS

HI-TECH PARTS | TECHNICAL SECTION

Universal fog lights and aluminium case painted black.

LED technology with low power consumption, avoiding putting the battery in danger due to excessive consumption.

Supplied with instructions on our engine guards. Fit engine guards between 23 and 25 mm diameter.

Equipped with a fuse and cables to connect directly to your battery and with a water proof switch to be installed on your handlebars.

ALUMINIUM housing designed to promote heat dissipation.

Optional metallic grill protections for offroad use.

Sells separately (Part# 9785N)

TECHNICAL CHARACTERISTICS:

Low consumption: 40w (20w per light)

Voltage: DC 12-24v

Lumens: 4000L M(2000L M/light)

Material: PC Lenses / ALUMINIUM housing

MOUNTING: To mount the auxiliary lights on the Puig engine guards use only one of the two spacers that carries the support and the allen screw M6 x 50.



MODEL	REF.	N
UNIVERSAL		
SET AUXILIARY HEADLIGHTS HOMOLOGATED	3489N	(*)
SET PROTECTION GRID (1)	9785N	(*)
SPARES		
WIRED KIT + SWITCH (2)	3541N	(*)
FLANGE + SUPPORT AUXILIARY LIGHTSZ (3)	3635N	(*)
SWITCH (4)	20438N	(*)

SPECIFIC SUPPORTS FOR AUXILIARY LIGHTS CONSULT PAGE 335.

(*) Check price with your distributor.

Check availability for motorcycle models at www.puig.tv typing in the searching window

AUXILIARY LIGHTS

SUPPORTS AUXILIARY LIGHTS

HI-TECH PARTS | TECHNICAL SECTION

FUNCTION

Allow mounting of the lights on bikes that don't mount tube engine guards.



MATERIAL

Made of steel.
Finished with epoxy black paint.



ADJUSTABLE

Sideways and on inclination.



REF. 1943N

2021 MODELS: www.puig.tv

SPECIFIC SUPPORTS	YEAR	REF.	N
BMW			
G310GS	17' - 20'	3487N	(*)
F850GS	18' - 20'	3642N	(*)
R NINE T	14' - 20'	3486N	(*)
HONDA			
CB500F	16' - 18'	3550N	(*)
CB500X	19' - 20'	3573N	(*)
CB650R NEO SPORTS CAFÉ	19' - 20'	3529N	(*)
CB1000R NEO SPORTS CAFE	18' - 20'	1943N	(*)
CRF1000L AFRICA TWIN	16' - 17'	3537N	(*)
CRF1100L AFRICA TWIN	20'	3870N	(*)
CRF1100L AFRICA TWIN ADVENTURE SPORTS	20'	3870N	(*)
KAWASAKI			
VERSYS 650	15' - 20'	3156N	(*)
VERSYS 1000	17' - 20'	3502N	(*)
Z900	17' - 20'	3549N	(*)

2021 MODELS: www.puig.tv

SPECIFIC SUPPORTS	YEAR	REF.	N
KTM			
790 DUKE	18' - 20'	3643N	(*)
SUZUKI			
DL650 V-STROM/XT	17' - 20'	3145N	(*)
KATANA	19' - 20'	3652N	(*)
SV650	16' - 20'	3485N	(*)
TRIUMPH			
TIGER 800 XC/XCX/XCA/XR/XRX/XRT	18' - 20'	1350N	(*)
STREET TRIPLE RS	17' - 19'	3536N	(*)
YAMAHA			
MT-07	18' - 20'	3146N	(*)
MT-09 TRACER	15' - 20'	3147N	(*)
MT-09 TRACER GT	18' - 20'	3147N	(*)
TENERE 700	19' - 20'	3816N	(*)
XSR700	16' - 20'	3146N	(*)
XT1200Z SUPER TÉNÉRÉ	18' - 20'	3644N	(*)



N
Black

(*) Check price with your distributor.

IMPORTANT: Indicate code color after part#. Example 0973A

HEADLIGHT PROTECTOR

HI-TECH PARTS | TECHNICAL SECTION

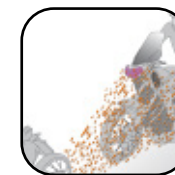

PROTECTION

Avoid impact of objects or insects on the headlight.



2021 MODELS: www.puig.tv				
MODEL	YEAR	REF.	Ⓜ	
BMW				
F700 GS	12' - 17'	8123W	(*)	
F750 GS	18' - 20'	9762W	(*)	
F800 GS	08' - 17'	8123W	(*)	
F850GS	18' - 20'	9762W	(*)	
F800 GS ADVENTURE	13' - 18'	8123W	(*)	
F850GS ADVENTURE	19' - 20'	3594W	(*)	
F900XR	20'	20395W	(*)	
R1200 GS	04' - 12'	7577W	(*)	

2021 MODELS: www.puig.tv				
MODEL	YEAR	REF.	Ⓜ	
R1200 GS	13' - 18'	7567W	(*)	
R1200 GS ADVENTURE	06' - 13'	7577W	(*)	
R1200 GS ADVENTURE	14' - 18'	7567W	(*)	
R1200 GS RALLYE/EXCLUSIVE	17' - 18'	7567W	(*)	
R1250 GS	18' - 20'	7567W	(*)	
R1250GS HP	18' - 20'	7567W	(*)	
R1250GS ADVENTURE	18' - 20'	7567W	(*)	
DUCATI				
MULTISTRADA 950	17' - 20'	9401W	(*)	



W
Transparent

(*) Check price with your distributor.
IMPORTANT: Indicate code color after part#. Example: 0973A

HEADLIGHT PROTECTOR

HI-TECH PARTS | TECHNICAL SECTION

2021 MODELS: www.puig.tv			
MODEL	YEAR	REF.	Ⓜ
MULTISTRADA 950 S	19' - 20'	9401W	(*)
MULTISTRADA 1200/S	15' - 17'	9401W	(*)
MULTISTRADA 1200 ENDURO/PRO	16' - 18'	9401W	(*)
MULTISTRADA 1260/S/S DJAIR	18' - 20'	9401W	(*)
MULTISTRADA 1260 PIKES PEAK	18' - 20'	9401W	(*)
MULTISTRADA 1260 ENDURO	19' - 20'	9401W	(*)
MULTISTRADA 1260 S GRAND TOUR	20'	9401W	(*)
HONDA			
CRF1000L AFRICA TWIN	16' - 19'	8714W	(*)
CRF1000L AFRICA TWIN ADVENTURE SPORTS	18' - 19'	8714W	(*)
CRF1100L AFRICA TWIN ADVENTURE SPORTS	20'	3821W	(*)
KTM			
390 ADVENTURE	20'	20416W	(*)
790 ADVENTURE/R	19' - 20'	3758W	(*)
1290 SUPER ADVENTURE R	17' - 20'	9470W	(*)
1290 SUPER ADVENTURE S	17' - 20'	9470W	(*)
SUZUKI			
DL650 V-STROM	12' - 16'	8125W	(*)
DL650 V-STROM XT	15' - 16'	8125W	(*)
DL650 V-STROM	17' - 20'	9736W	(*)
DL650 V-STROM XT	17' - 20'	9736W	(*)
DL1000 V-STROM	15' - 16'	8126W	(*)
DL1000 V-STROM	17' - 20'	9737W	(*)
DL1000 V-STROM XT	17' - 20'	9737W	(*)
DL1050 V-STROM	20'	20413W	(*)
DL1050XT V-STROM	20'	20413W	(*)
TRIUMPH			
TIGER 800	11' - 14'	8124W	(*)
TIGER 800 XC	11' - 14'	8124W	(*)
TIGER 800 XC/XCX/XCA	15' - 20'	8124W	(*)
TIGER 800 XR/XRX/XRT	15' - 20'	8124W	(*)
TIGER 900	20'	20377W	(*)
TIGER 900 GT	20'	20377W	(*)
TIGER 900 GT LOW	20'	20377W	(*)

2021 MODELS: www.puig.tv			
MODEL	YEAR	REF.	Ⓜ
TIGER 900 GT PRO	20'	20377W	(*)
TIGER 900 RALLY	20'	20377W	(*)
TIGER 900 RALLY PRO	20'	20377W	(*)
TIGER EXPLORER	12' - 15'	8124W	(*)
TIGER EXPLORER XC	13' - 15'	8124W	(*)
TIGER EXPLORER XC/XR/XRX/XRT/XCX/XCA	16' - 18'	8124W	(*)
YAMAHA			
MT-07 TRACER	16' - 19'	9215W	(*)
MT-07 TRACER	20'	20437W	(*)
MT-07 TRACER GT	19'	9215W	(*)
MT-09 TRACER	15' - 17'	8127W	(*)
MT-09 TRACER	18' - 20'	9728W	(*)
MT-09 TRACER GT	18' - 20'	9728W	(*)
TENERE 700	19' - 20'	3733W	(*)
XT1200Z SUPER TÉNÉRÉ	10' - 20'	8417W	(*)

LIGHTS

HI-TECH PARTS | TECHNICAL SECTION



1
REF. 1944N



2
REF. 3448N

	MODEL	REF.	Ⓝ
1	HEADLIGHT HOMOLOGATED 175 x 160,4mm 11W HIGH/9W LOW/4W POS C/BLACK	1944N	(*)
2	OPTIC AND LIGHT H3 55w-12v LONG	3448N	(*)
2	OPTIC AND LIGHT H3 55w-12v SHORT	3449N	(*)



W
Transparent



N
Black

(*) Check price with your distributor.
IMPORTANT: Indicate code color after part#. Example: 0973A

(*) Check price with your distributor.
IMPORTANT: Indicate code color after part#. Example 0973A

TURN SIGNAL COVERS

HI-TECH PARTS | TECHNICAL SECTION



MATERIAL
Manufactured in steel.
Finished with epoxy paint.



OPTICS
Hides the gap that leaves
the OEM turn signal when
it is replaced.

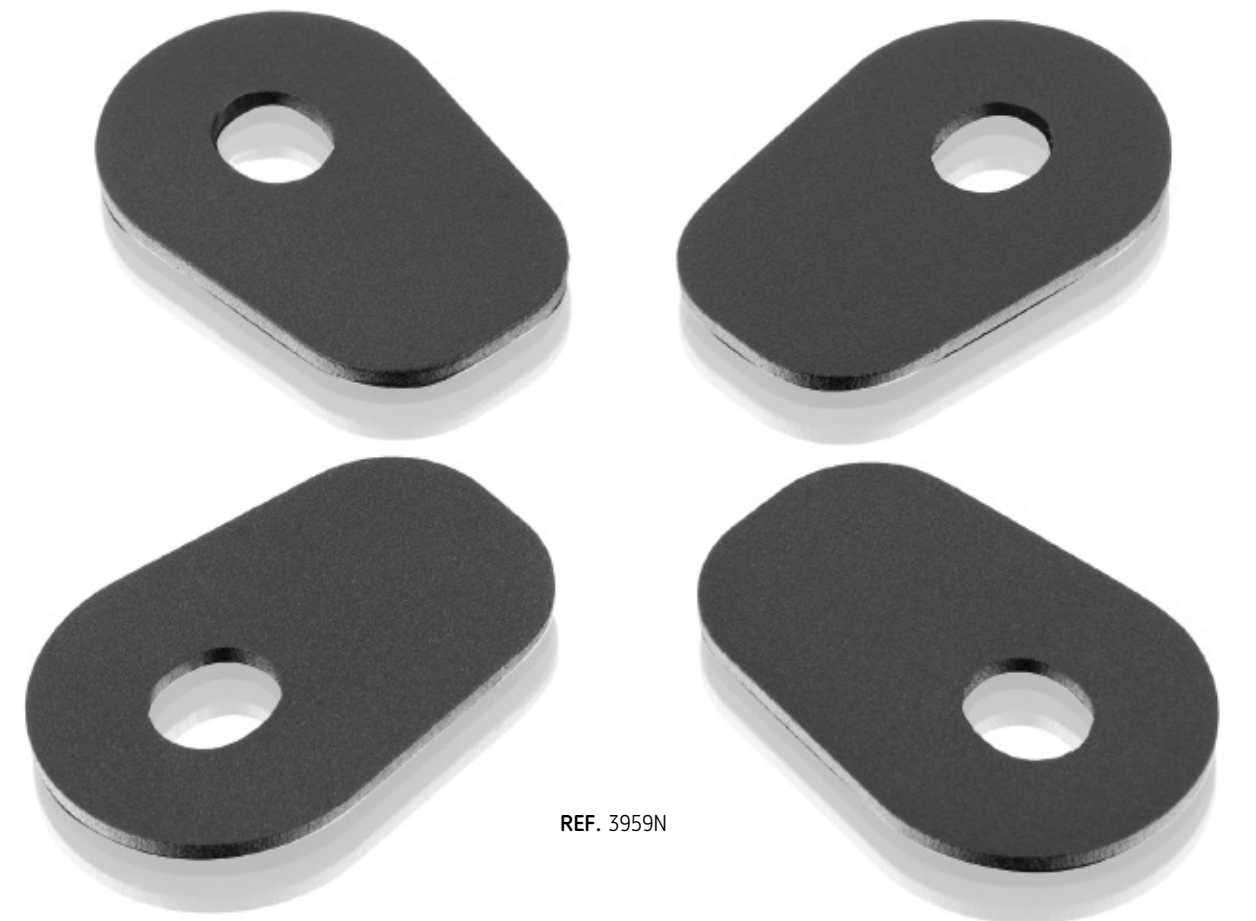

N
Black

TURN SIGNAL COVERS

HI-TECH PARTS

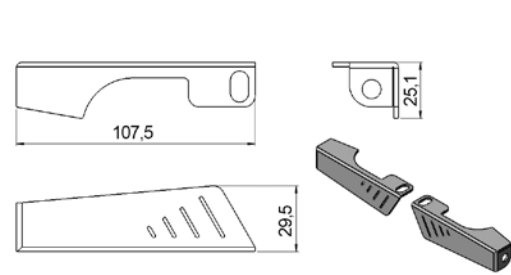

REF. 3507

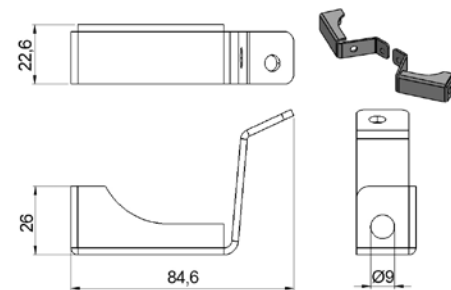

REF. 3528

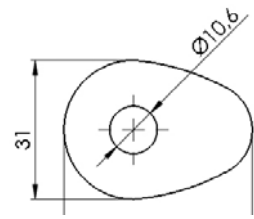

REF. 3956

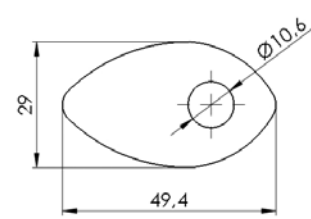

REF. 3957

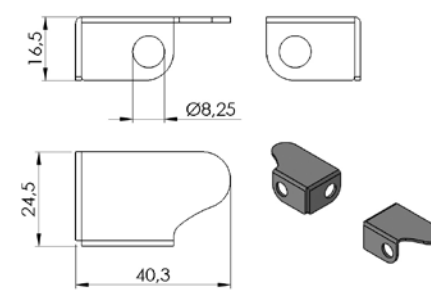

REF. 9735

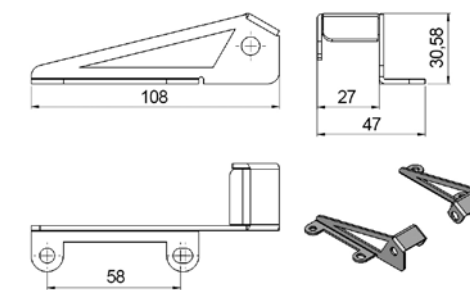

REF. 9740

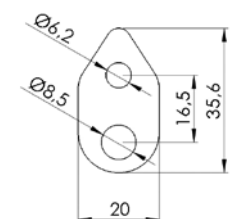

REF. 9765

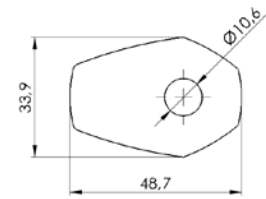

REF. 3958

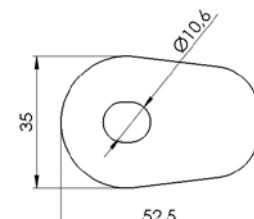

REF. 3959

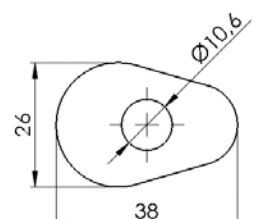

REF. 3960

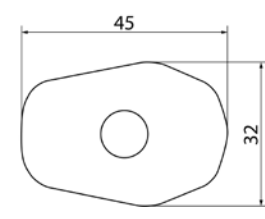

REF. 4751

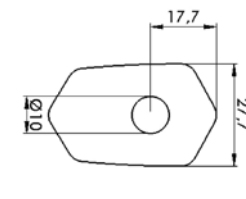

REF. 9788

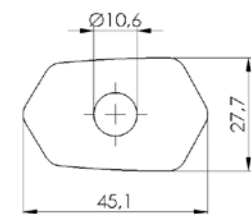

REF. 5329

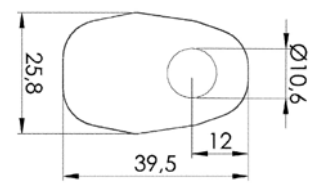

REF. 9453

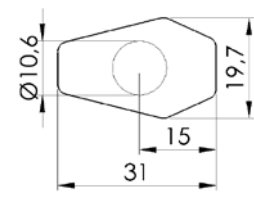

REF. 9655

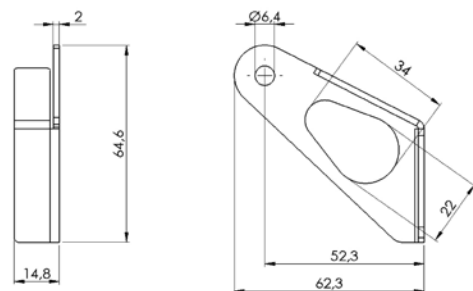

REF. 9465

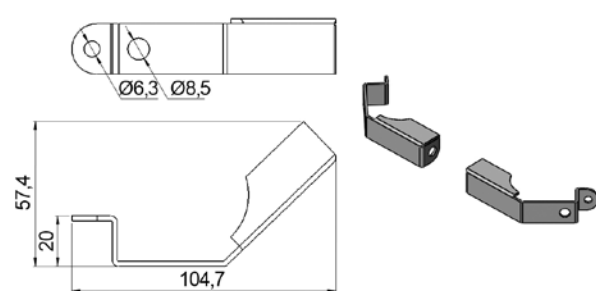

REF. 9672

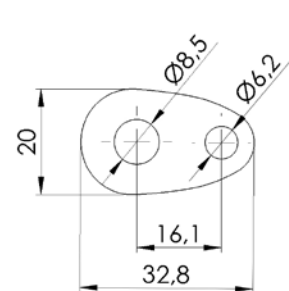

REF. 9676



N
Black

2021 MODELS: www.puig.tv			
MODEL	YEAR	REF.	N
HARLEY DAVIDSON			
SPORTSTER 883 IRON	16' - 20'	9735 (#)	(*)
HONDA			
CB125F	15' - 20'	3957	(*)
CB300F	15' - 20'	3957	(*)
CB500F/X	13' - 18'	3957	(*)
CB500F/X	19' - 20'	3957	(*)
CB600F HORNET	00' - 15'	3957	(*)
CB650F	14' - 20'	3957	(*)
CB900F HORNET	02' - 05'	3957	(*)
CB125R NEO SPORTS CAFE	18' - 20'	9655	(*)
CB300R NEO SPORTS CAFE	18' - 20'	9655	(*)
CB650R NEO SPORTS CAFE	19' - 20'	3528	(*)

2021 MODELS: www.puig.tv			
MODEL	YEAR	REF.	N
CB1000R	08' - 16'	3957	(*)
CBF1000F	10' - 16'	3957	(*)
CBR125R	11' - 20'	3957	(*)
CBR250R	11' - 14'	3957	(*)
CBR300R	15' - 17'	3957	(*)
CBR500R	13' - 20'	3957	(*)
CBR600F	86' - 13'	3957	(*)
CBR600F	86' - 13'	3957	(*)
CBR600RR	03' - 16'	3957	(*)
CBR650F	14' - 20'	3957	(*)
CBR650R	19' - 20'	9655	(*)
CBR1000RR FIREBLADE	04' - 13'	3957	(*)
CBR1000RR FIREBLADE/SP	14' - 16'	3957	(*)

(#) Bracket set front Puig turn signals.
 (S) Bracket set rear Puig turn signals.
 (*) Bracket set front Puig turn signals + Turn Signals Ref.4489K
 (*) Check price with your distributor
IMPORTANT: Indicate code color after part#. Example 0973A

TURN SIGNAL COVERS

HI-TECH PARTS

2021 MODELS: www.puig.tv			
MODEL	YEAR	REF.	N
CROSSRUNNER	11' - 20'	3957	(*)
CROSSTOURER	12' - 20'	3957	(*)
CRF1100L AFRICA TWIN	20'	3957	(*)
CRF1100L AFRICA TWIN ADVENTURE SPORTS	20'	3957	(*)
CMX 500 REBEL	17' - 20'	9672 (#)	(*)
INTEGRA 750	16' - 20'	3957	(*)
INTEGRA 750S	14' - 16'	3957	(*)
NC700S/X	12' - 13'	3957	(*)
NC750S/X	14' - 20'	3957	(*)
MSX125	14' - 20'	3957	(*)
INDIAN			
SCOUT BOBBER	18'-20'	9740 (#)	(*)
SCOUT BOBBER	18'-20'	9765 (&)	(*)
KAWASAKI			
ER-6N/F	12' - 16'	5329	(*)
NINJA 250SL	15' - 16'	5329	(*)
NINJA 300	13' - 17'	5329	(*)
NINJA 400	18' - 20'	5329	(*)
NINJA 650	17' - 20'	5329	(*)
VERSYS-X 300	17' - 20'	5329	(*)
VERSYS 650	07' - 09'	3959	(*)
VERSYS 650	10' - 20'	5329	(*)
VERSYS 1000	12' - 20'	5329	(*)
VULCAN S	15' - 20'	9676 (#)	(*)
VULCAN S CAFE	17' - 20'	9676 (#)	(*)
Z250SL	15' - 16'	5329	(*)
Z300	15' - 17'	5329	(*)
Z650	17' - 20'	5329	(*)
Z750	07' - 12'	3959	(*)
Z750S	05' - 06'	3959	(*)
Z750R	11' - 12'	5329	(*)
Z800/E	13' - 16'	5329	(*)
Z900	17' - 20'	5329	(*)
Z900	17' - 19'	9788 (*)	(*)
Z900RS	18' - 20'	5329	(*)
Z900RS CAFÉ	18' - 20'	5329	(*)
Z1000	10' - 19'	5329	(*)

2021 MODELS: www.puig.tv			
MODEL	YEAR	REF.	N
Z1000R	17' - 20'	5329	(*)
Z1000SX	14' - 20'	5329	(*)
ZR7S	01' - 03'	3959	(*)
ZRX1200S	01' - 07'	3959	(*)
ZX-6R	94' - 04'	3959	(*)
ZX-6R 636	13' - 16'	5329	(*)
ZX-9R	94' - 04'	3959	(*)
ZX-10R	04' - 05'	3959	(*)
ZX-12R	00' - 06'	3959	(*)
SUZUKI			
DL250 V-STROM	17' - 20'	3956	(*)
DL650 V-STROM	12' - 20'	3958	(*)
DL650XT V-STROM	15' - 20'	3958	(*)
DL1000 V-STROM	14' - 20'	3958	(*)
DL1000XT V-STROM	17' - 20'	3958	(*)
GSF600 BANDIT	96' - 99'	3956	(*)
GSF600 BANDIT	00' - 04'	3958	(*)
GSF650 BANDIT	05' - 11'	3958	(*)
GSF650S BANDIT	05' - 14'	3958	(*)
GSF1200 BANDIT	01' - 06'	3958	(*)
GSF1250S BANDIT	07' - 13'	3958	(*)
GSF1250S BANDIT	15' - 16'	3958	(*)
GSR750	11' - 16'	3958	(*)
GSX650F	08' - 17'	3958	(*)
GSX1250F	10' - 17'	3958	(*)
GSX-S125	17' - 20'	3956	(*)
GSX-S750	17' - 20'	3958	(*)
GSX-S1000	15' - 20'	3958	(*)
GSX-S1000F	15' - 20'	3958	(*)
GSX-R125	17' - 20'	3956	(*)
GSX-R250	17' - 20'	3956	(*)
GSX-R600/750	96' - 00'	3956	(*)
GSX-R600/750	01' - 05'	3958	(*)
GSX-R1000	01' - 04'	3958	(*)
GSX-R1000	15' - 16'	3958	(*)
GSX-R1000/R	17' - 20'	9453	(*)
INAZUMA	13' - 17'	3956	(*)
KATANA	19'	9453	(*)

2021 MODELS: www.puig.tv			
MODEL	YEAR	REF.	N
SFV650 GLADIUS	09' - 15'	3958	(*)
SV650	16' - 20'	3958	(*)
SV650S	03' - 08'	3958	(*)
SV1000S	03' - 05'	3956	(*)
YAMAHA			
FAZER8	13' - 16'	3960	(*)
FJR1300A/AS	06' - 20'	3959	(*)
FZ1/FAZER	06' - 15'	3960	(*)
FZ6	04' - 06'	3960	(*)
FZ6 FAZER	07' - 08'	3960	(*)
FZ8 FAZER	10' - 12'	3960	(*)
FZS600/1000 FAZER	01' - 05'	3959	(*)
MT-125	15' - 20'	3960	(*)
MT-03	16' - 20'	3960	(*)
MT-07	14' - 20'	3960	(*)
MT-07 TRACER	16' - 20'	3960	(*)
MT-07 TRACER	20'	3960	(*)
MT-09	13' - 16'	3960	(*)
MT-09 (SUBSTITUTION KIT INTERMITTENT POSITION)	17' - 20'	9465	(*)
MT-09 SP (SUBSTITUTION KIT INTERMITTENT POSITION)	18' - 20'	9465	(*)
MT-09 TRACER	15' - 20'	3960	(*)
MT-09 TRACER GT	18' - 20'	3960	(*)
MT-10	16' - 20'	3960	(*)
MT-10 SP	17' - 20'	3960	(*)
TDM900	02' - 13'	3960	(*)
XJ6	09' - 16'	3960	(*)
XJ6 DIVERSION	09' - 16'	3960	(*)
XJ6 DIVERSION F	10' - 16'	3960	(*)
XSR700	16' - 20'	3960	(*)
XSR700 XTRIBUTE	19' - 20'	3960	(*)
XSR900	16' - 20'	3960	(*)
XV950	14' - 20'	3507 (#)	(*)
XV950R	14' - 20'	3507 (#)	(*)
XV950 RACER	14' - 20'	3507 (#)	(*)
XT660Z TÉNÉRÉ	12' - 20'	3959	(*)
YZF 600 R THUNDERCAT	96' - 02'	3959	(*)

2021 MODELS: www.puig.tv			
MODEL	YEAR	REF.	N
YZF 1000 R THUNDERACE	96' - 03'	3959	(*)
YZF-R125	19' - 20'	3960	(*)
YZF-R1	98' - 01'	3959	(*)
YZF-R1	02' - 14'	3960	(*)
YZF-R1	20'	3960	(*)
YZF-R1M	20'	3960	(*)
YZF-R3	15' - 20'	3960	(*)
YZF-R6	99' - 02'	3959	(*)
YZF-R6	03' - 16'	3960	(*)
YZF-R6	17' - 20'	3960	(*)



N
Black

(#) Bracket set front Puig turn signals.
(&) Bracket set rear Puig turn signals.
(*) Bracket set front Puig turn signals + Turn Signals Ref.4489K
(*) Check price with your distributor
IMPORTANT: Indicate code color after part#. Example 0973A



N
Black

(#) Bracket set front Puig turn signals.
(&) Bracket set rear Puig turn signals.
(*) Bracket set front Puig turn signals + Turn Signals Ref.4489K
(*) Check price with your distributor
IMPORTANT: Indicate code color after part#. Example 0973A

SEQUENTIAL TURN SIGNALS

HI-TECH PARTS



// THIN

HOMOLOGATED

MODEL	REF.	N
SET OF SEQUENTIAL COLOR BLACK WITH CLEAR LENS OF 12 LEDS 76 x 27,40 mm.	9624N	(*)



// PIN

HOMOLOGATED

MODEL	REF.	N
SET OF SEQUENTIAL COLOR BLACK WITH CLEAR LENS OF 12 LEDS 70,20 x 24,30 mm.	3155N	(*)



// TOWER

HOMOLOGATED

NEW!

MODEL	REF.	N
SET OF SEQUENTIAL COLOR BLACK WITH CLEAR LENS OF LEDS 70 x 24 mm. 12v 0,5w	20424N	(*)



N
Black



TURN SIGNAL

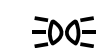

FRONT RUNNING LIGHT



REAR RUNNING LIGHT



STOP LIGHT

CHECK CONNECTIONS TURN SIGNALS ON **PAGE 366**.

TO AVOID CONNECTION PROBLEMS. CHECK THE TECHNICAL SHEET ON **PAGE 365**.



N
Black

TURN SIGNALS
HI-TECH PARTS



// PIRAMIDE

HOMOLOGATED

MODEL	REF.	N
SET BLACK CLEAR LENSES LED 59,15 x 33,54 mm. 12v 0,5w	9941N	(*)



// CHIP

HOMOLOGATED

MODEL	REF.	N
SET BLACK CLEAR LENSES LED 24 x 16 mm. 12v 0,4w	9942N	(*)



// SPARKLY

HOMOLOGATED

MODEL	REF.	N
SET BLACK CLEAR LENSES LED 138,43 x 45,12 mm. 12v 0,5w	9944N	(*)



// HOUSE

HOMOLOGATED

MODEL	REF.	N
SET BLACK CLEAR LENSES LED 70 x 24 mm. 12v 0,5w	9946N	(*)



N
Black



TURN SIGNAL



FRONT RUNNING LIGHT



REAR RUNNING LIGHT



STOP LIGHT



N
Black

CHECK CONNECTIONS TURN SIGNALS ON PAGE 366.
TO AVOID CONECTION PROBLEMS. CHECK THE TECHNICAL SHEET ON PAGE 365.



N
Black



TURN SIGNAL



FRONT RUNNING LIGHT



REAR RUNNING LIGHT



STOP LIGHT



N
Black

CHECK CONNECTIONS TURN SIGNALS ON PAGE 366.
TO AVOID CONECTION PROBLEMS. CHECK THE TECHNICAL SHEET ON PAGE 365.



// BUOY

HOMOLOGATED

MODEL	REF.	N
SET BLACK CLEAR LENSES LED 78 x 33 mm. 12v 5w	9947N	(*)

SUITABLE FOR HANDLEBARS INNER DIAMETER FROM 13 TO 18 mm.

// BUOY II

HOMOLOGATED

MODEL	REF.	N
SET BLACK CLEAR LENSES LED 77,80 x 33 mm. 12v 5w	9948N	(*)

SUITABLE FOR HANDLEBARS INNER DIAMETER FROM 13 TO 18 mm.

// TINY

HOMOLOGATED

MODEL	REF.	N
SET BLACK CLEAR LENSES LED 27 x 34,20 mm. 12v 1w	9314N	(*)

// MINIMAL

HOMOLOGATED

MODEL	REF.	N
LED TURN SIGNAL BLACK BASE SHORT STEMP/ CLEAR LENS BY PAIR 45 x 20 mm. 12v 0,6w	4906N	(*)
LED TURN SIGNAL BLACK BASE LONG STEMP/ CLEAR LENS BY PAIR 60 x 20 mm. 12v 0,8w	4907N	(*)



N
Black



TURN SIGNAL



FRONT RUNNING LIGHT



REAR RUNNING LIGHT



STOP LIGHT



N
Black

CHECK CONNECTIONS TURN SIGNALS ON PAGE 366.
TO AVOID CONECTION PROBLEMS. CHECK THE TECHNICAL SHEET ON PAGE 365.



N
Black



TURN SIGNAL



FRONT RUNNING LIGHT



REAR RUNNING LIGHT



STOP LIGHT



N
Black

CHECK CONNECTIONS TURN SIGNALS ON PAGE 366.
TO AVOID CONECTION PROBLEMS. CHECK THE TECHNICAL SHEET ON PAGE 365.

TURN SIGNALS
HI-TECH PARTS

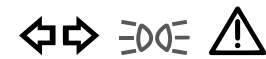

// LIGHT

HOMOLOGATED

MODEL	REF.	N
FRONT SET OF BLACK COLOR WITH SMOKED LENSES OF 50,80 x 25,30 mm. POSITION + TURN SIGNAL	9315N	(*)
REAR SET OF BLACK COLOR WITH SMOKED LENSES OF 50,80 x 25,30 mm. POSITION + STOP + TURN SIGNAL	9557N	(*)

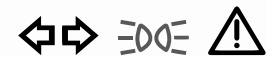

// DOUBLE

HOMOLOGATED

MODEL	REF.	N
FRONT SET OF BLACK COLOR WITH SMOKED LENSES OF 58,20 x 43,30 mm. POSITION + TURN SIGNAL	9316N	(*)
REAR SET OF BLACK COLOR WITH SMOKED LENSES OF 58,20 x 43,30 mm. POSITION + STOP + TURN SIGNAL	9556N	(*)

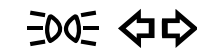

// STICK

HOMOLOGATED

MODEL	REF.	N
FRONT SET OF BLACK COLOR WITH SMOKED LENSES OF 48 x 20 mm. POSITION + TURN SIGNAL	9317N	(*)
REAR SET OF BLACK COLOR WITH SMOKED LENSES OF 48 x 20 mm. POSITION + STOP + TURN SIGNAL	9555N	(*)



// OPEN

HOMOLOGATED

MODEL	REF.	N
SET BLACK CLEAR LENSES LED 47,3 x 26,5 mm. 12v 2w	8997N	(*)



N
Black



TURN SIGNAL



FRONT RUNNING LIGHT



REAR RUNNING LIGHT



STOP LIGHT



N
Black

CHECK CONNECTIONS TURN SIGNALS ON **PAGE 366**.
TO AVOID CONECTION PROBLEMS. CHECK THE TECHNICAL SHEET ON **PAGE 365**.



N
Black



TURN SIGNAL



FRONT RUNNING LIGHT



REAR RUNNING LIGHT



STOP LIGHT



N
Black

CHECK CONNECTIONS TURN SIGNALS ON **PAGE 366**.
TO AVOID CONECTION PROBLEMS. CHECK THE TECHNICAL SHEET ON **PAGE 365**.

TURN SIGNALS
HI-TECH PARTS

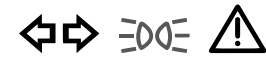
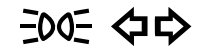

// CURVE

HOMOLOGATED

MODEL	REF.	N
FRONT LED TURN SIGNAL BLACK BASE/ CLEAR LENS BY PAIR 49,50 x 25 mm. POSITION + TURN SIGNAL	9084N	(*)
REAR LED TURN SIGNAL BLACK BASE/ CLEAR LENS BY PAIR 49,50 x 25 mm. POSITION + STOP + TURN SIGNAL	9151N	(*)

// DID

HOMOLOGATED

MODEL	REF.	N
SET BLACK CLEAR LENSES LED 62,8 x 15,4 mm. 12v 2w	6074N	(*)

// POWER LED

HOMOLOGATED

MODEL	REF.	N
SET BLACK CLEAR LENSES LED 70,15 x 21,76 mm. 12v 1w	5609N	(*)

// PUTT

HOMOLOGATED

MODEL	REF.	N
SET BLACK CLEAR LENSES LED 62,8 x 15,4 mm. 12v 2w	3734N	(*)



N
Black



TURN SIGNAL



FRONT RUNNING LIGHT



REAR RUNNING LIGHT



STOP LIGHT



N
Black

CHECK CONNECTIONS TURN SIGNALS ON **PAGE 366**.
TO AVOID CONECTION PROBLEMS. CHECK THE TECHNICAL SHEET ON **PAGE 365**.



N
Black



TURN SIGNAL



FRONT RUNNING LIGHT



REAR RUNNING LIGHT



STOP LIGHT



N
Black

CHECK CONNECTIONS TURN SIGNALS ON **PAGE 366**.
TO AVOID CONECTION PROBLEMS. CHECK THE TECHNICAL SHEET ON **PAGE 365**.

TURN SIGNALS
HI-TECH PARTS



// SNAKE

HOMOLOGATED

MODEL	REF.	N
SET BLACK CLEAR LENSES LED 80 x 28,3 mm. 12v 1w	5239N	(*)

// FLECHA

HOMOLOGATED

MODEL	REF.	W
LED TURN SIGNAL SHORT ARM CLEAR LENS 67 x 30 mm. 12v 2w	4173W	(*)
LED TURN SIGNAL LONG ARM CLEAR LENS 87 x 30 mm. 12v 2w	4174W	(*)

// ZAFIRO

HOMOLOGATED

MODEL	REF.	W
LED TURN SIGNAL SHORT ARM CLEAR LENS 73 x 35 mm. 12v 1w	2585W	(*)
LED TURN SIGNAL LONG ARM CLEAR LENS 93 x 35 mm. 12v 1w	2586W	(*)

// LANZA

HOMOLOGATED

MODEL	REF.	N	D
LED TURN SIGNAL ALUMINIUM BASE/CLEAR LENS BY PAIR 79 x 33 mm. 12v 0,9w	4824D	(*)	
LED TURN SIGNAL BLACK BASE/CLEAR LENS BY PAIR 79 x 33 mm.12v 0,9w	4824N	(*)	



N
Black



TURN SIGNAL



FRONT RUNNING LIGHT



REAR RUNNING LIGHT



STOP LIGHT

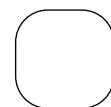

W
Transparent

CHECK CONNECTIONS TURN SIGNALS ON **PAGE 366**.
TO AVOID CONECTION PROBLEMS. CHECK THE TECHNICAL SHEET ON **PAGE 365**.

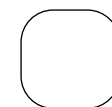

W
Transparent



TURN SIGNAL



FRONT RUNNING LIGHT



REAR RUNNING LIGHT



STOP LIGHT



N
Black

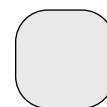

D
Anodized

CHECK CONNECTIONS TURN SIGNALS ON **PAGE 366**.
TO AVOID CONECTION PROBLEMS. CHECK THE TECHNICAL SHEET ON **PAGE 365**.



// PEAK

HOMOLOGATED

MODEL	REF.	N	E
LED TURN SIGNAL BLACK BASE SHORT STEM/ CLEAR LENS BY PAIR 66 x 27 mm. 12v 0,5w	4491N	(*)	
LED TURN SIGNAL BLACK BASE LONG STEM/ CLEAR LENS BY PAIR 86 x 27 mm. 12v 0,5w	4492N	(*)	
LED TURN SIGNAL CARBON LOOK BASE SHORT STEM/ CLEAR LENS BY PAIR 66 x 27 mm. 12v 0,5w	4493C	(*)	
LED TURN SIGNAL CARBON LOOK BASE LONG STEM/ CLEAR LENS BY PAIR 86 x 27 mm. 12v 0,5w	4494C	(*)	

// CIGAR

HOMOLOGATED

MODEL	REF.	N
LED TURN SIGNAL BLACK BASE/ CLEAR LENS BY PAIR 91 x 20 mm. 12v 1,4w	4346N	(*)

// AX

HOMOLOGATED

MODEL	REF.	N
SET BLACK CLEAR LENSES LED 63,4 x 18,2 mm. 12v 1w	5510N	(*)

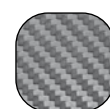

C
Carbon look



TURN SIGNAL



FRONT RUNNING LIGHT



REAR RUNNING LIGHT



STOP LIGHT



N
Black

CHECK CONNECTIONS TURN SIGNALS ON PAGE 366.

TO AVOID CONECTION PROBLEMS. CHECK THE TECHNICAL SHEET ON PAGE 365.



N
Black



TURN SIGNAL



FRONT RUNNING LIGHT



REAR RUNNING LIGHT



STOP LIGHT

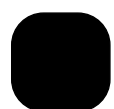

N
Black

CHECK CONNECTIONS TURN SIGNALS ON PAGE 366.

TO AVOID CONECTION PROBLEMS. CHECK THE TECHNICAL SHEET ON PAGE 365.

TURN SIGNALS
HI-TECH PARTS



// SPEED

HOMOLOGATED

MODEL	REF.	T
JBLACK BASE/ AMBER LENS BY PAIR 60 x 19 mm.	(*) 2546T	(*)
CARBON LOOK BASE/ AMBER LENS BY PAIR 60 x 19 mm. 12v 2,16w	(*) 1077T	(*)

(*) These models cannot be homologated, because do not fulfill the EU standards, their C-Carbon Look use limited for tradeshows exclusively, closed exhibitions and for race tracks.

// BALA

HOMOLOGATED

MODEL	REF.	T
BLACK BASE/ AMBER LEN x UNIT 78 x 87 mm.	0911T	(*)

// RUBI

HOMOLOGATED

MODEL	REF.	C
SET CARBON LOOK CLEAR LENSES LED 53,30 x 28,10 mm. 12v 1w	4919	(*)

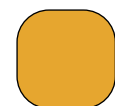

T
Orange



TURN SIGNAL



FRONT RUNNING LIGHT



REAR RUNNING LIGHT



STOP LIGHT

CHECK CONNECTIONS TURN SIGNALS ON PAGE 366.
TO AVOID CONECTION PROBLEMS. CHECK THE TECHNICAL SHEET ON PAGE 365.

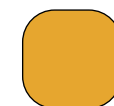

T
Orange

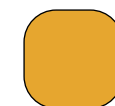

T
Orange



TURN SIGNAL



FRONT RUNNING LIGHT



REAR RUNNING LIGHT



STOP LIGHT

CHECK CONNECTIONS TURN SIGNALS ON PAGE 366.
TO AVOID CONECTION PROBLEMS. CHECK THE TECHNICAL SHEET ON PAGE 365.

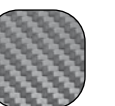

C
Carbon look

TURN SIGNALS

HI-TECH PARTS



// STAR

HOMOLOGATED

MODEL	REF.	PRICE
LED TURN SIGNAL CARBON LOOK BASE SHORT STEM/ AMBER LENS + SMOKE LENS + LASER LENS BY PAIR 70 x 35 mm. 12v 21w	2548C	(*)
LED TURN SIGNAL CARBON LOOK BASE LONG STEM/ AMBER LENS + SMOKE LENS+LASER LENS BY PAIR 90 x 35 mm. 12v 21w	2549C	(*)
LED TURN SIGNAL BLACK BASE SHORT STEM/ AMBER LENS + SMOKE LENS+LASER LENS BY PAIR 69 x 42 mm. 12v 21w	4175N	(*)
LED TURN SIGNAL BLACK BASE LONG STEM/ AMBER LENS + SMOKE LENS+LASER LENS BY PAIR 89 x 42 mm. 12v 21w	4176N	(*)
AMBER BULB STAR TURN SIGNAL 12v-23w (BOX 10 UNITS)	1622T	(*)
CLEAR BULB STAR TURN SIGNAL 12v-23w (BOX 10 UNITS)	1622W	(*)
AMBER BULB STAR TURN SIGNAL 12v-6w (BOX 10 UNITS)	4596T	(*)
CLEAR BULB STAR TURN SIGNAL 12v-23w (BOX 10 UNITS)	4596W	(*)

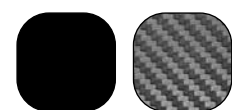

N Black
C Carbon look



TURN SIGNAL



FRONT RUNNING LIGHT



REAR RUNNING LIGHT



STOP LIGHT

CHECK CONNECTIONS TURN SIGNALS ON PAGE 366.

TO AVOID CONECTION PROBLEMS. CHECK THE TECHNICAL SHEET ON PAGE 365.



// MINI

HOMOLOGATED

MODEL	REF.	PRICE
LED TURN SIGNAL CARBON LOOK BASE SHORT STEM/ AMBER + SMOKE LENS + LASER LENS 75 x 37 mm. 12v 21w	4042C	(*)
JLED TURN SIGNAL CARBON LOOK BASE LONG STEM/ AMBER + SMOKE LENS + LASER LENS 95 x 37 mm. 12v 21w	4043C	(*)
CLEAR BULB MINI TURN SIGNAL (BOX 10 UNITS) 12v-23w	1622W	(*)
AMBER BULB MINI TURN SIGNAL (BOX 10 UNITS) 12v 23w	1622T	(*)

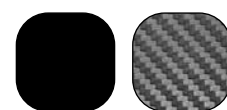

N Black
C Carbon look



// DIAMOND

HOMOLOGATED

MODEL	REF.	PRICE
LED TURN SIGNAL CARBON LOOK BASE SHORT STEM/ AMBER + SMOKE LENS + LASER LENS 59,8 x 38,3 mm.	2771T	(*)
AMBER BULB DIAMOND TURN SIGNAL 12v-23w (BOX 10 UNITS)	1622T	(*)
CLEAR BULB DIAMOND TURN SIGNAL 12v-23w (BOX 10 UNITS)	1622W	(*)
AMBER BULB DIAMOND TURN SIGNAL 12v-6w (BOX 10 UNITS)	4596T	(*)
CLEAR BULB DIAMOND TURN SIGNAL 12v- 6w (BOX 10 UNITS)	4596W	(*)

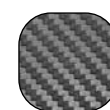

C Carbon look



TURN SIGNAL



FRONT RUNNING LIGHT



REAR RUNNING LIGHT



STOP LIGHT

CHECK CONNECTIONS TURN SIGNALS ON PAGE 366.

TO AVOID CONECTION PROBLEMS. CHECK THE TECHNICAL SHEET ON PAGE 365.



// MASA

HOMOLOGATED

MODEL	REF.	PRICE
LED TURN SIGNAL CARBON LOOK BASE SHORT STEM/ AMBER LENS + SMOKE LENS + LASER LENS BY PAIR 63 x 24 mm 12v 21w	4871N	(*)
AMBER BULB MASA TURN SIGNAL 12v-23w (BOX 10 UNITS)	1622T	(*)
CLEAR BULB MASA TURN SIGNAL 12v-23w (BOX 10 UNITS).	1622W	(*)
AMBER BULB MASA TURN SIGNAL 12v-23w (BOX 10 UNITS)	4596T	(*)
CLEAR BULB MASA TURN SIGNAL (BOX 10 UNITS)	4596W	(*)



N Black

TURN SIGNALS

HI-TECH PARTS



// EYE

HOMOLOGATED

MODEL	REF.	PRICE
BLACK BASE/ CLEAR LENS BY PAIR 58,7 x 21 mm. 12v 6w	6475N	(*)

N
Black

TURN SIGNAL



FRONT RUNNING LIGHT



REAR RUNNING LIGHT



STOP LIGHT

N
Black

CHECK CONNECTIONS TURN SIGNALS ON PAGE 366.
TO AVOID CONECTION PROBLEMS. CHECK THE TECHNICAL SHEET ON PAGE 365.



// TIP

HOMOLOGATED

MODEL	REF.	PRICE
BLACK BASE/ AMBER LENS BY PAIR 67,4 x 29 mm. 12v 21w	6476N	(*)
AMBER BULB TIP TURN SIGNAL 12v-23w (BOX 10 UNITS)	1622T	(*)
CLEAR BULB TIP TURN SIGNAL 12v-23w (BOX 10 UNITS).	1622W	(*)
AMBER BULB TIP TURN SIGNAL 12v-23w (BOX 10 UNITS)	4596T	(*)
CLEAR BULB TIP TURN SIGNAL 12v-23w (BOX 10 UNITS).	4596W	(*)

RESISTOR SET FOR LEDS TURN SIGNALS AND FLASHER RELAYS

HI-TECH PARTS

// TECHNICAL INFO TURN SIGNALS CONNECTIONS:

Most of the bikes use bi-metallic relays. Its frequency (which is the one that sets the pace of the turn signals) depend on the amperage circulating through the circuit. When replacing the turn signals from OEM to aftermarket ones which carry a difference power, consequently they vary the amperage circulation through the circuit that causes a change on the frequency of the turn signals rhythm. If otherwise, the motorcycle uses electronic relay (which frequency works independently from the amperage circulating through the circuit) the change of turn signals from OEM to aftermarket, should not affect the frequency of the turn signals rhythm.

Note: In case of doubt of what type of relay the motorcycle uses, we recommend to check the turn signal rhythm after switching form OEM to aftermarket.

If the OEM turn signals are replaced by aftermarket ones that use incandescent bulbs, we need to check they use the same power. In case it is different, we need to replace the turn signals bulbs for others that use the same power as OEM ones. On our catalog, we have available bulbs of different power.

If the OEM turn signals are replaced by LED ones (of much less power than incandescent bulbs), we have two options to balance the frequency of rhythm:

1. Incorporate a parallel relay in the right circuit and the other on the left curcuit. If we replace four turn signals, we need to use a resistance Part# 42980. If otherwise, only two turn signals are replaced (one on each side), we need to use a resistance Part# 42980. The resistances are supplied with a scheme for a parallel connection.

Note: On most of the bikes, the warning function of the bike is disabled if the resistance is used.

2. Identify the intermittent relay of the motorcycle (location and number of pins) and replace it for its corresponding from the list supplied on most of the bikes, the warning functions work correctly when the relay is replaced.

Note: we can find some motorcycles in the market that do not have an intermittent relay, obviously in this case it cannot be replaced. Moreover, if on the blinking function intervenes more than one relay, it is possible that replacing only one relay does not solve the problem.



MODEL	REF.	PRICE
RESISTORS SET OF 3'9 /25w FOR LEDS TURN SIGNALS	42980	(*)
RESISTORS SET OF 25w FOR MOTORCYCLES THAT MOUNT REAR LEDS TURN SIGNALS, KEEPING ORIGINAL TURN SIGNALS	58730	(*)
FLASHER RELAY 2 PINS	4823N	(*)
FLASHER RELAY 3 PINS	4822N	(*)
FLASHER RELAY 4 PINS	5180N	(*)
FLASHER RELAY 7 PINS	3540N	(*)
LED LAMP AMBER FOR TURN SIGNAL	1625T	(*)

(*) Check price with your distributor.
IMPORTANT: Indicate code color after part#. Example 0973A

CONNECTORS LEADS

HI-TECH PARTS



REF. 3164 REF. 3703 REF. 3704 REF. 3846 REF. 3849 REF. 3850 REF. 3853

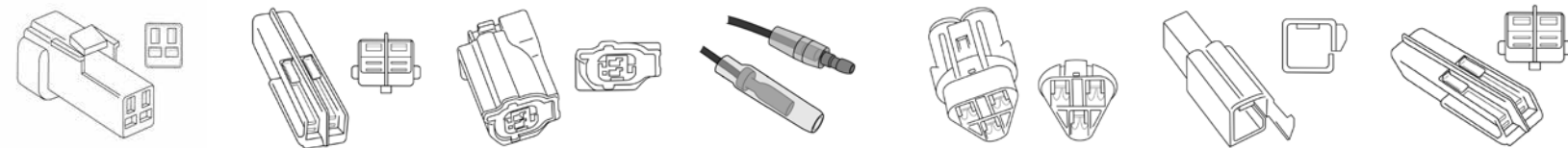

REF. 3871 REF. 3873 REF. 3888 REF. 3889 REF. 3890 REF. 3891 REF. 4854

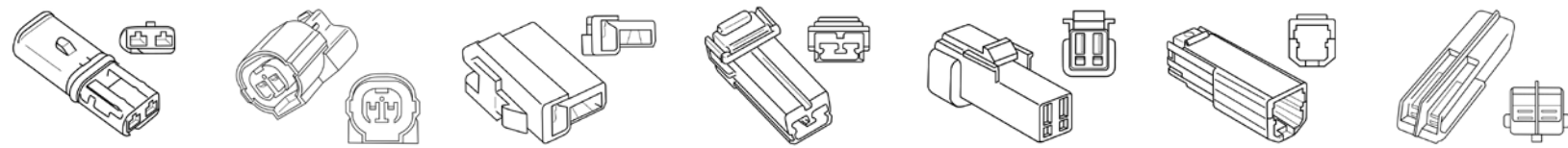

REF. 4856 REF. 4860 REF. 4863 REF. 4869 REF. 8510 REF. 9772 REF. 20312

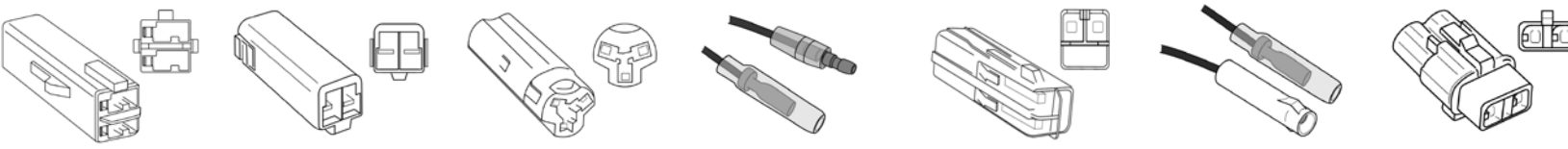

MODEL	YEAR	FRONT TURN SIGNAL EXTENSION SET REF.	PRICE	REAR TURN SIGNAL EXTENSION SET REF.	PRICE	LICENSE LIGHT EXTENSION REF.	PRICE
BMW		3871N (#)	(*)	3871N (#)	(*)		
DUCATI		3891N (#)	(*)	3891N (#)	(*)		
HARLEY DAVIDSON		3889N (#)	(*)	3889N (#)	(*)		
HONDA				3873N (#)	(*)		
CB500F	19' - 20'	4854N	(*)	4854N	(*)	3853N	(*)
CB650R NEO SPORT CAFÉ	19' - 20'			4854N	(*)	3853N	(*)
CB1000R NEO SPORTS CAFÉ	19' - 20'			4854N	(*)	3853N	(*)
CBR500R	19' - 20'	4854N	(*)	4854N	(*)	3853N	(*)
CBR650R	19' - 20'	4854N	(*)	4854N	(*)	3853N	(*)
CRF1000L AFRICA TWIN	20'	4854N	(*)	4854N	(*)	3853N	(*)
KAWASAKI							
MINJA 125	19' - 20'	4856N	(*)	4856N	(*)	3850N	(*)
NINJA 650	20'	3703N	(*)	3703N	(*)	3850N	(*)
NINJA 1000 SX	20'	3703N	(*)	3703N	(*)	20312N	(*)
VERSYS 650	15' - 19'	3703N	(*)	3703N	(*)	20312N	(*)
VERSYS 650	20'	3703N	(*)	3703N	(*)	3850N	(*)
VERSYS 1000	19' - 20'	3703N	(*)	3703N	(*)	20312N	(*)
Z125	19' - 20'	4856N	(*)	4856N	(*)	3850N	(*)
Z400	19' - 20'	4856N	(*)	4856N	(*)	3850N	(*)
Z650	20'	3703N	(*)	3703N	(*)	3850N	(*)
Z900	19'	4856N	(*)	4856N	(*)		
Z900	20'	3703N	(*)	3703N	(*)	20312N	(*)
ZH2	20'	3703N	(*)	3703N	(*)	20312N	(*)
ZX-6R	19' - 20'	4856N	(*)	4856N	(*)	20312N	(*)
MV AGUSTA		3890N (#)	(*)	3890N (#)	(*)		
SUZUKI							
SV650	18' - 20'	4863N	(*)	4863N	(*)	3850N	(*)
SV650X	18' - 20'	4863N	(*)	4863N	(*)	3850N	(*)
GSX-S125	20'	4869N	(*)	4869N	(*)		
GSX-R125	20'	4869N	(*)	4869N	(*)		
GSX-S750	19' - 20'	4860N	(*)	4860N	(*)	4860N	(*)
TRIUMPH							
STREET TRIPLE S	20'	9772N	(*)	9772N	(*)		
STREET TRIPLE R / RS	20'	9772N	(*)	9772N	(*)		
YAMAHA						3849N (#)	(*)
MT-125	20'	4863N	(*)	4863N	(*)	3850N	(*)
MT-03	20'	3704N	(*)	3704N	(*)		
MT-07	18' - 20'	4863N	(*)	4863N	(*)		
T-MAX 560	20'	3704N	(*)	3704N	(*)	3846N	(*)
TENERE 700	19' - 20'	4863N	(*)	4863N	(*)		
MT-07 TRACER	20'	3704N	(*)	3704N	(*)		
YZF-R125	19' - 20'	4863N	(*)	4863N	(*)	3850N	(*)
YZF-R3	15' - 20'	4869N	(*)	4869N	(*)	3850N	(*)
YZF-R1	20'	3704N	(*)	3704N	(*)		
UNIVERSAL		4869N (#)	(*)	4869N (#)	(*)		



LENGTHS OF EXTENSIONS: 300 mm.
 (#) Check the above diagrams.
IMPORTANT: Indicate code color after part#. Example 0973A

INTEGRATED TURN SIGNALS

HI-TECH PARTS

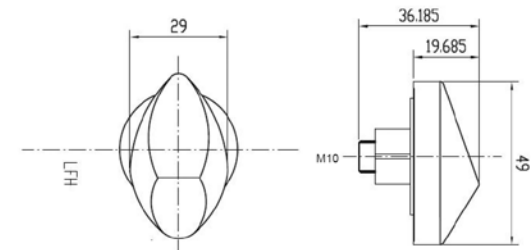

REF. 4487

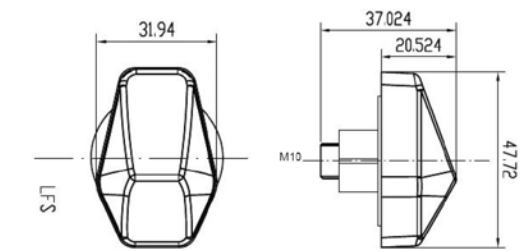

REF. 4488

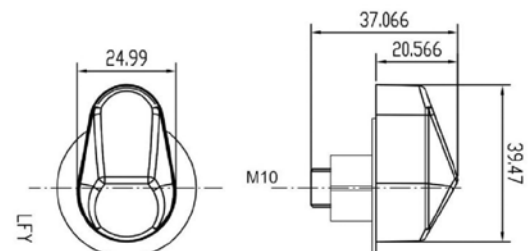

REF. 4489

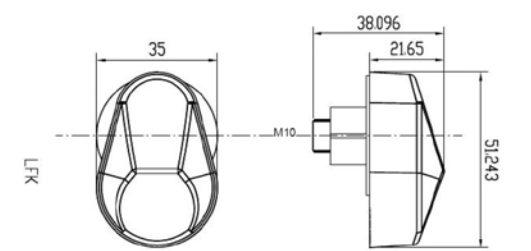

REF. 4490



TURN SIGNAL

HOMOLOGATED

REF. 4487K	12v 2w
REF. 4488K	12v 1w
REF. 4489K	12v 1w
REF. 4490K	12v 2w



2021 MODELS: www.puig.tv

MODEL	YEAR	REF.	PRICE
HONDA			
CB500F/X	13' - 17'	4487K	(*)
CB600F HORNET	05' - 16'	4487K	(*)
CB650F	14' - 16'	4487K	(*)
CB900F HORNET	02' - 05'	4487K	(*)
CB1000R	08' - 16'	4487K	(*)
CBF1000F	10' - 16'	4487K	(*)
CBR500R	13' - 17'	4487K	(*)
CBR600F	99' - 07'	4487K	(*)
CBR600F	11' - 14'	4487K	(*)

2021 MODELS: www.puig.tv

MODEL	YEAR	REF.	PRICE
CBR650F	14' - 16'	4487K	(*)
CBR600RR	03' - 16'	4487K	(*)
CBR900RR FIRE BLADE	98' - 03'	4487K	(*)
CBR1000RR	04' - 16'	4487K	(*)
CROSSRUNNER	11' - 17'	4487K	(*)
CROSSTOURER	14' - 17'	4487K	(*)
MSX125	14' - 17'	4487K	(*)
NC700S/X	12' - 13'	4487K	(*)
NC750S/X	14' - 17'	4487K	(*)

KAWASAKI

VERSYS 650	07' - 09'	4490K	(*)
Z750	07' - 12'	4490K	(*)
Z750S	05' - 06'	4490K	(*)
ZR7S	01' - 03'	4490K	(*)
ZRX1200S	01' - 07'	4490K	(*)
ZX-6R	94' - 04'	4490K	(*)
ZX-9R	94' - 04'	4490K	(*)
ZX-10R	04' - 05'	4490K	(*)
ZX-12R	00' - 06'	4490K	(*)

SUZUKI

DL650A V-STROM	12' - 16'	4488K	(*)
DL650XT V-STROM	15' - 16'	4488K	(*)
DL1000 V-STROM	14' - 16'	4488K	(*)
GSF600 BANDIT	00' - 04'	4488K	(*)
GSF650 BANDIT	05' - 11'	4488K	(*)
GSF650S BANDIT	05' - 14'	4488K	(*)
GSF1200 BANDIT	01' - 06'	4488K	(*)
GSF1250S BANDIT	07' - 13'	4488K	(*)
GSR750	11' - 16'	4488K	(*)
GSX650F	08' - 17'	4488K	(*)
GSX1250F	10' - 17'	4488K	(*)
GSX-R600/750	01' - 05'	4488K	(*)
GSX-R1000	01' - 04'	4488K	(*)
GSX-S1000	15' - 17'	4488K	(*)
GSX-S1000F	15' - 17'	4488K	(*)

2021 MODELS: www.puig.tv

MODEL	YEAR	REF.	PRICE
SFV650 GLADIUS	09' - 15'	4488K	(*)
SV650S	03' - 08'	4488K	(*)
YAMAHA			
FAZER8	13' - 16'	4489K	(*)
FZ1/FAZER	06' - 15'	4489K	(*)
FZ6/FAZER	04' - 08'	4489K	(*)
FZ8/FAZER		4489K	(*)
MT-07	14' - 17'	4489K	(*)
MT-09	13' - 16'	4489K	(*)
MT-09 TRACER	15' - 17'	4489K	(*)
TDM900	02' - 13'	4489K	(*)
XJ6/DIVERSION/F		4489K	(*)
XSR700	16' - 18'	4489K	(*)
YZF-R1	02' - 14'	4489K	(*)
YZF-R3	15' - 17'	4489K	(*)
YZF-R6	03' - 16'	4489K	(*)

Technical characteristics: 12v 0,5w

TO AVOID CONECTION PROBLEMS. CHECK THE TECHNICAL SHEET ON **PAGE 365**.

Technical characteristics: 12v 0,5w

TO AVOID CONECTION PROBLEMS. CHECK THE TECHNICAL SHEET ON **PAGE 365**.

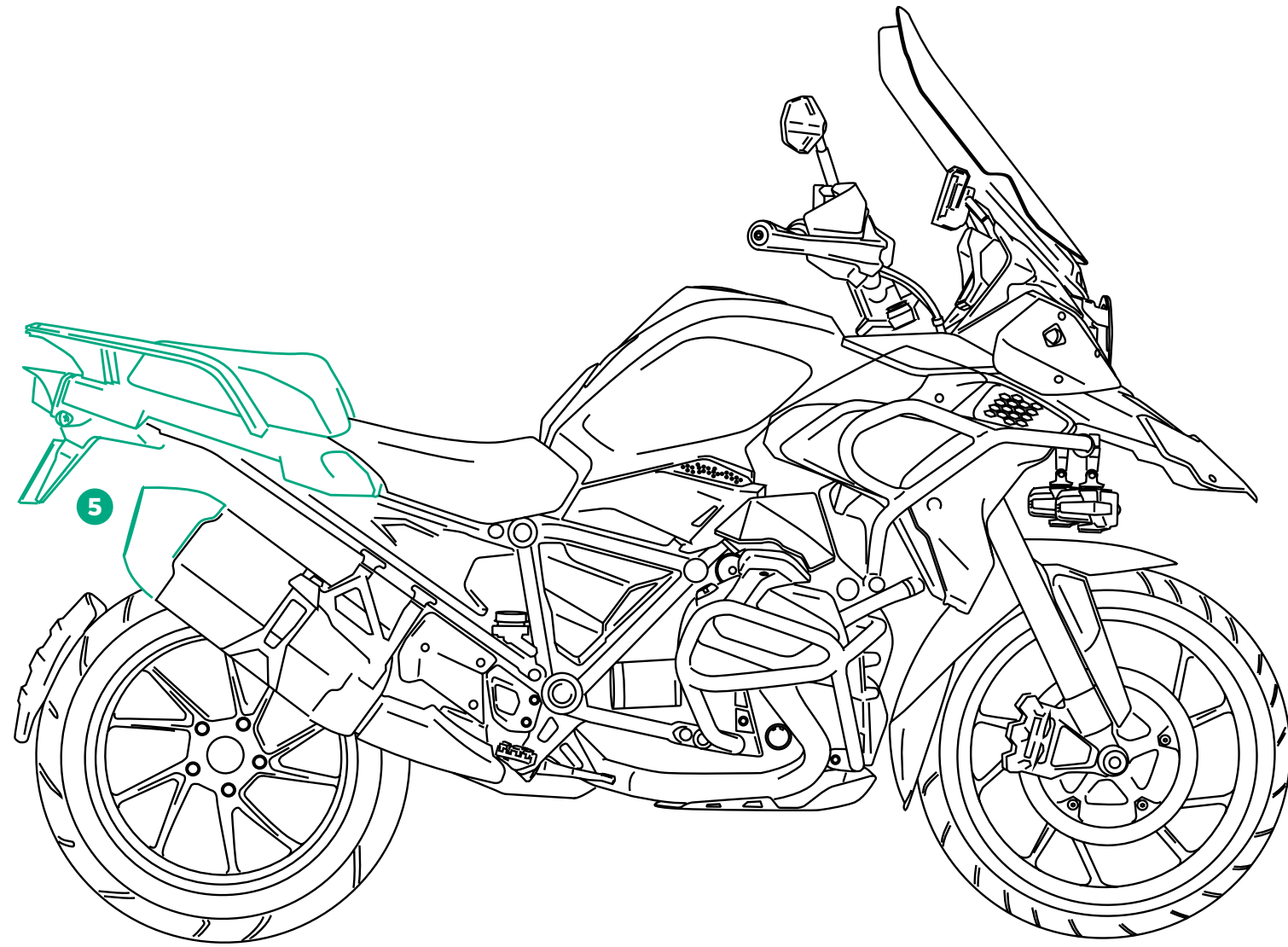

REAR AREA

END TUBE FOR EXHAUST	387
LICENSE SUPPORTS	373
LIGHTING LICENSE SUPPORT	380
SUPPORT FOR ORIGINAL TURN SIGNAL	383
TAIL LIGHTS	388

LICENSE SUPPORTS

HI-TECH PARTS | TECHNICAL SECTION



ADJUSTABLE
Fixed or adjustable
on inclination.

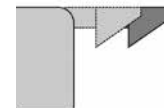

TURN SIGNALS
Adjustable lodge for
turn signals.

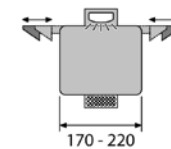

UNIVERSAL
Most suitable for
license plates.

KIT
It is supplied with light
and reflector, both
homologated.
According to models.

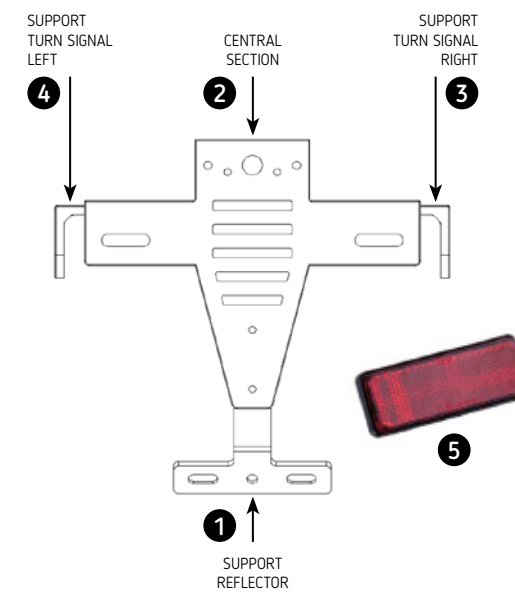

The license support is not designed to
mount the oem turn signals.
Oem connectors are not delivered to
connect lighting license.



REF. 9353N

SPARES	REF.	PRICE
METALLIC SUPPORT TO MOVE THE CATADIOPTRIC (1)	4480I	(*)
NYLON SUPPORT TO DISPLACE THE CATADIOPTRIC (1)	1553N	(*)
NYLON SUPPORT FOR LICENSE PLATE (2)	1558N	(*)
NYLON SUPPORT FOR TURN SIGNAL RIGHT (3)	1559N	(*)
NYLON SUPPORT FOR TURN SIGNAL LEFT (4)	1615N	(*)
CATADIOPTRIC HOMOLOGATED DE 8,8 x 3,4 cm. C/RED (5)	4481R	(*)
CATADIOPTRIC HOMOLOGATED DE 7,5 x 2,5 cm. C/RED (5)	5729R	(*)

LIGHTING LICENSE SUPPORTS SEE PAGE 380.
TURN SIGNALS FOR LICENSE PLATE HOLDER SEE PAGE 347.

UNIVERSAL MODELS	ADJUSTABLE	T. SIGNAL SUPPORT	IIINCLUDE KIT	REF.	PRICE
UNIVERSAL	SI/NO (&)	YES ADJUST,	NO	1539N	(*)

FOR SPECIFIC MODELS SEE PAGE 374.

LICENSE SUPPORTS

HI-TECH PARTS

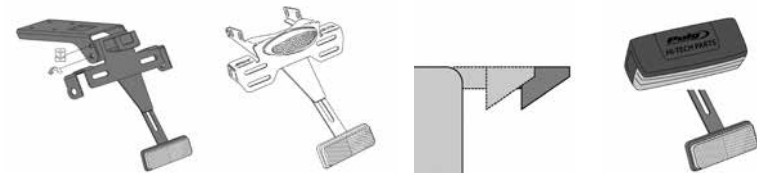

2021 MODELS: www.puig.tv

MODEL	YEAR	ADJUSTABLE	BRAKE REAR LIGHT- INCLUDED	TURN LIGHT SUPPORT	INCLUDE KIT	REF.	N
APRILIA							
RSV4	09' - 12'	YES/NO (&)	NO	YES ADJUST.	YES	4978	(*)
RSV4 FACTORY	13' - 14'	YES/NO (&)	NO	YES ADJUST.	YES	4978	(*)
RSV4 RF	15' - 20'	YES/NO (&)	NO	YES ADJUST.	YES	4978	(*)
RSV4 RR	15' - 20'	YES/NO (&)	NO	YES ADJUST.	YES	4978	(*)
TUONO V4R	11' - 14'	YES/NO (&)	NO	YES ADJUST.	YES	4978	(*)
TUONO V4 1100 RR	15' - 20'	YES/NO (&)	NO	YES ADJUST.	YES	4978	(*)
TUONO V4 1100 FACTORY	15' - 20'	YES/NO (&)	NO	YES ADJUST.	YES	4978	(*)
BMW							
C600 SPORT	12' - 15'	YES/NO (&)	NO	YES ADJUST.	YES	6061	(*)
C650 SPORT	16' - 20'	YES/NO (&)	NO	YES ADJUST.	YES	6061	(*)
F750GS	18' - 20'	YES/NO (&)	NO	YES ADJUST.	YES	20398	(*)
F850GS	18' - 20'	YES/NO (&)	NO	YES ADJUST.	YES	20398	(*)
F850GS ADVENTURE	19' - 20'	YES/NO (&)	NO	YES ADJUST.	YES	20398	(*)
R1200 R	15' - 18'	YES/NO (&)	NO	YES ADJUST.	NO	8541	(*)
R1200 RS	15' - 18'	YES/NO (&)	NO	YES ADJUST.	NO	8541	(*)
R1250 R	19' - 20'	YES/NO (&)	NO	YES ADJUST.	NO	8541	(*)
R1250 RS	19' - 20'	YES/NO (&)	NO	YES ADJUST.	NO	8541	(*)
S1000 R	14' - 20'	YES/NO (&)	NO	YES ADJUST.	YES	5319	(*)
S1000 RR	09' - 11'	YES/NO (&)	NO	YES ADJUST.	YES	5319	(*)
S1000 RR	12' - 18'	YES/NO (&)	NO	YES ADJUST.	YES	5319	(*)
S1000 RR	19' - 20'	YES/NO (&)	NO	YES ADJUST.	YES	3705	(*)
DERBI							
GPR 125	09' - 14'	YES/NO (&)	NO	YES ADJUST.	YES	5546	(*)
DUCATI							
PANIGALE V2	20'	YES/NO (&)	NO	YES ADJUST.	YES	9751	(*)
PANIGALE 1100 V4	18' - 20'	YES/NO (&)	NO	YES ADJUST.	YES	9751	(*)
PANIGALE 1100 V4S	18' - 20'	YES/NO (&)	NO	YES ADJUST.	YES	9751	(*)
MONKEY 125	18' - 20'	YES/NO (&)	NO	YES ADJUST.	YES	20401	(*)
MONSTER 620	02' - 06'	NO	NO	NO	NO	1771	(*)
MONSTER 695	06' - 07'	NO	NO	NO	NO	1771	(*)
MONSTER 696	08' - 14'	YES/NO (&)	NO	YES	YES	4733	(*)
MONSTER 796	10' - 14'	YES/NO (&)	NO	YES	YES	4979	(*)
MONSTER 797	17' - 20'	YES/NO (&)	NO	YES	YES	9496	(*)
MONSTER 800	03' - 04'	NO	NO	NO	NO	1771	(*)
MONSTER 821	14' - 17'	YES/NO (&)	NO	YES ADJUST.	YES	7602	(*)
MONSTER 821	18' - 20'	YES/NO (&)	NO	YES ADJUST.	YES	9496	(*)

2021 MODELS: www.puig.tv

MODEL	YEAR	ADJUSTABLE	BRAKE REAR LIGHT- INCLUDED	TURN LIGHT SUPPORT	INCLUDE KIT	REF.	N
MONSTER 1000/S	03' - 05'	NO	NO	NO	NO	1771	(*)
MONSTER 1100/S	09' - 10'	YES/NO (&)	NO	YES	YES	4979	(*)
MONSTER 1100 EVO	11' - 13'	YES/NO (&)	NO	YES	YES	4979	(*)
MONSTER 1200/S	14' - 16'	YES/NO (&)	NO	YES ADJUST.	YES	7563	(*)
MONSTER 1200/S	17' - 20'	YES/NO (&)	NO	YES ADJUST.	YES	9496	(*)
MONSTER S2R	05' - 07'	NO	NO	NO	NO	1771	(*)
MONSTER S4R	04' - 06'	NO	NO	NO	NO	1771	(*)
STREETFIGHTER 848	12' - 15'	YES/NO (&)	NO	YES ADJUST.	YES	5320	(*)
STREETFIGHTER 1100	09' - 12'	YES/NO (&)	NO	YES ADJUST.	YES	5320	(*)
STREETFIGHTER 1100 S	09' - 13'	YES/NO (&)	NO	YES ADJUST.	YES	5320	(*)
STREETFIGHTER V4/S	20'	YES/NO (&)	NO	YES ADJUST.	YES	9751	(*)
SUPERSPORT 939/S	17' - 20'	YES/NO (&)	NO	YES ADJUST.	YES	9496	(*)
HARLEY DAVIDSON							
SPORTSTER 883 IRON	13' - 20'	NO	NO	NO	YES	9994	(*)
HONDA							
CB125R NEO SPORTS CAFE	18' - 20'	YES/NO (&)	NO	YES ADJUST.	YES	9653	(*)
CB300R NEO SPORTS CAFE	18' - 20'	YES/NO (&)	NO	YES ADJUST.	YES	9653	(*)
CB500F	16' - 20'	YES/NO (&)	NO	YES ADJUST.	YES	8722	(*)
CB650F	14' - 16'	YES/NO (&)	NO	YES ADJUST.	YES	7100	(*)
CB650F	17' - 20'	YES/NO (&)	NO	YES ADJUST.	YES	7100	(*)
CB650R NEO SPORTS CAFE	19' - 20'	YES/NO (&)	NO	YES ADJUST.	YES	3527	(*)
CBR500R	16' - 20'	YES/NO (&)	NO	YES ADJUST.	YES	8722	(*)
CBR650R	19' - 20'	YES/NO (&)	NO	YES ADJUST.	YES	3527	(*)
CBR600RR	03' - 06'	NO	NO	YES	NO	1612	(*)
CBR600RR	07' - 12'	NO	YES	YES	NO	4453	(*)
CBR600RR	13' - 16'	NO	NO	YES	YES	6545	(*)
CBR1000RR FIREBLADE	04' - 07'	NO	NO	YES	YES	1766	(*)
CBR1000RR FIREBLADE/SP/SP2	17' - 19'	YES/NO (&)	NO	YES ADJUST.	YES	9456	(*)
CBR1000RR FIREBLADE/SP	20'	YES/NO (&)	NO	YES ADJUST.	YES	20489	(*)
CRF1100L AFRICA TWIN	20'	YES/NO (&)	NO	YES ADJUST.	YES	3842	(*)
CRF1100L AFRICA TWIN ADVENTURE SPORTS	20'	YES/NO (&)	NO	YES ADJUST.	YES	3842	(*)
CMX 500 REBEL	17' - 20'	NO	YES	NO	YES ONLY CATADIOPTRIC	9671	(*)
INTEGRA 750	16' - 20'	YES/NO (&)	NO	YES ADJUST.	YES	8725	(*)
INTEGRA 750S	16' - 19'	YES/NO (&)	NO	YES ADJUST.	YES	8725	(*)
MSX125	14' - 15'	YES/NO (&)	NO	YES ADJUST.	YES	7552	(*)
MSX125	16' - 20'	YES/NO (&)	NO	YES ADJUST.	YES	9257	(*)
NC750S/X	16' - 20'	YES/NO (&)	NO	YES ADJUST.	YES	8725	(*)
SCOOPY SH125i (-)	07' - 08'	YES/NO (&)	NO	NO	NO	4847	(*)



N
Black

(*) Check price with your distributor.
 (**) Required original piece from Yamaha ref. 150-F1685-10
 (&) Produced not adjustable with a removable fastener.
 (-) It's necessary to cut the rear fender.
IMPORTANT: Indicate code color after part#. Example 0973A

LICENSE SUPPORTS

HI-TECH PARTS

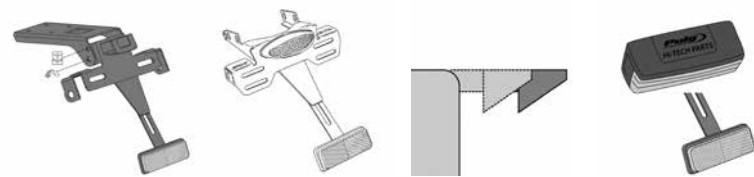

2021 MODELS: www.puig.tv

MODEL	YEAR	ADJUSTABLE	BRAKE REAR LIGHT- INCLUDED	TURN LIGHT SUPPORT	INCLUDE KIT	REF.	Ⓝ
SCOOPY SH150i (-)	07' - 08'	YES/NO (&)	NO	NO	NO	4847	(*)
X-ADV	17' - 20'	YES/NO (&)	YES	YES ADJUST.	YES	9706	(*)
INDIAN							
SCOUT BOBBER	18' - 20'	NO	NO	NO	YES	9741	(*)
KAWASAKI							
ER-6N	12' - 16'	YES/NO (&)	NO	YES ADJUST.	YES	6096	(*)
ER-6F	12' - 16'	YES/NO (&)	NO	YES ADJUST.	YES	6096	(*)
NINJA 125	19' - 20'	YES/NO (&)	NO	YES ADJUST.	YES	7788	(*)
NINJA 250SL	15' - 16'	YES/NO (&)	NO	YES ADJUST.	YES	7788	(*)
NINJA 300	13' - 17'	YES/NO (&)	NO	YES ADJUST.	YES	6546	(*)
NINJA 400	18' - 20'	YES/NO (&)	NO	YES ADJUST.	YES	9629	(*)
NINJA 650	17' - 20'	YES/NO (&)	NO	YES ADJUST.	YES	9353	(*)
NINJA 1000SX	20'	YES/NO (&)	NO	YES ADJUST.	YES	5735	(*)
NINJA H2 SX	18' - 20'	YES/NO (&)	NO	YES ADJUST.	YES	9707	(*)
VERSYS-X 300	17' - 20'	YES/NO (&)	NO	YES ADJUST.	YES	9475	(*)
VERSYS 650	10' - 14'	YES/NO (&)	NO	YES ADJUST.	YES	5318	(*)
VERSYS 650	15' - 20'	YES/NO (&)	NO	YES ADJUST.	YES	7789	(*)
VERSYS 1000	19' - 20'	YES/NO (&)	NO	YES ADJUST.	YES	3495	(*)
VERSYS 1000	17' - 18'	YES/NO (&)	NO	YES ADJUST.	YES	9450	(*)
VULCAN S	15' - 20'	NO	YES	NO	YES ONLY CATADIOPTRIC	9675	(*)
VULCAN S CAFE	17' - 20'	NO	YES	NO	YES ONLY CATADIOPTRIC	9675	(*)
Z125	19' - 20'	YES/NO (&)	YES	YES ADJUST.	YES	7788	(*)
Z250SL	15' - 16'	YES/NO (&)	NO	YES ADJUST.	YES	7788	(*)
Z300	15' - 17'	YES/NO (&)	NO	YES ADJUST.	YES	6546	(*)
Z400	19' - 20'	YES/NO (&)	NO	YES ADJUST.	YES	9629	(*)
Z650	17' - 20'	YES/NO (&)	NO	YES ADJUST.	YES	9353	(*)
Z750	04' - 06'	NO	NO	YES	NO	1607	(*)
Z750	07' - 12'	NO	NO	YES	NO	4529	(*)
Z750S	05' - 06'	NO	NO	YES	NO	1607	(*)
Z750R	11' - 12'	NO	NO	YES	NO	4529	(*)
Z800	13' - 16'	YES/NO (&)	NO	YES ADJUST.	YES	6548	(*)
Z800E	13' - 16'	YES/NO (&)	NO	YES ADJUST.	YES	6548	(*)
Z900	17' - 20'	YES/NO (&)	NO	YES ADJUST.	YES	9388	(*)
Z900RS	18' - 20'	YES/NO (&)	NO	YES ADJUST.	YES	9597	(*)
Z900RS CAFÉ	18' - 20'	YES/NO (&)	NO	YES ADJUST.	YES	9597	(*)

2021 MODELS: www.puig.tv

MODEL	YEAR	ADJUSTABLE	BRAKE REAR LIGHT- INCLUDED	TURN LIGHT SUPPORT	INCLUDE KIT	REF.	Ⓝ
Z1000	03' - 06'	NO	NO	YES	NO	1607	(*)
Z1000	07' - 09'	NO	NO	YES	NO	4529	(*)
Z1000	10' - 13'	YES/NO (&)	NO	YES ADJUST.	YES	5317	(*)
Z1000	14' - 20'	YES/NO (&)	NO	YES ADJUST.	YES	7102	(*)
Z1000R	17' - 20'	YES/NO (&)	NO	YES ADJUST.	YES	7102	(*)
Z1000SX	11' - 16'	YES/NO (&)	NO	YES ADJUST.	YES	5735	(*)
Z1000SX	17' - 20'	YES/NO (&)	NO	YES ADJUST.	YES	5735	(*)
ZX-6R	03' - 04'	NO	NO	YES	NO	1607	(*)
ZX-6R	18' - 20'	YES/NO (&)	NO	YES ADJUST.	YES	3180	(*)
ZX-10R	16' - 20'	YES/NO (&)	NO	YES ADJUST.	YES	8726	(*)
ZX-10RR	17' - 20'	YES/NO (&)	NO	YES ADJUST.	YES	8726	(*)
ZX-10R SE	18' - 20'	YES/NO (&)	NO	YES ADJUST.	YES	8726	(*)
KTM							
125 DUKE	17' - 20'	YES/NO (&)	NO	YES ADJUST.	YES	9492	(*)
390 DUKE	17' - 20'	YES/NO (&)	NO	YES ADJUST.	YES	9492	(*)
790 DUKE	18' - 20'	YES/NO (&)	NO	YES ADJUST.	YES	9683	(*)
1290 SUPERDUKE R	14' - 16'	YES/NO (&)	NO	YES ADJUST.	YES	7106	(*)
1290 SUPERDUKE R	17' - 19'	YES/NO (&)	NO	YES ADJUST.	YES	7106	(*)
1290 SUPERDUKE R	20'	YES/NO (&)	NO	YES ADJUST.	YES	20449	(*)
1290 SUPERDUKE GT	16' - 19'	YES/NO (&)	NO	YES ADJUST.	YES	8728	(*)
RC125/RC390	14' - 20'	YES/NO (&)	NO	YES ADJUST.	YES	7107	(*)
KYMCO							
AK550	17' - 20'	YES/NO (&)	NO	NO	YES	9534	(*)
MV AGUSTA							
BRUTALE 990 RR	10' - 13'	YES/NO (&)	NO	YES ADJUST.	YES	5738	(*)
BRUTALE 1090 RR	10' - 18'	YES/NO (&)	NO	YES ADJUST.	YES	5738	(*)
SUZUKI							
DL650 V-STROM	04' - 11'	YES/NO (&)	NO	NO	YES	6272	(*)
DL650 V-STROM	12' - 16'	YES/NO (&)	NO	YES	YES	6372	(*)
DL650XT V-STROM	15' - 16'	YES/NO (&)	NO	YES	YES	6372	(*)
GSR600 (-)	06' - 11'	NO	NO	YES	YES	4076	(*)
GSR750	11' - 16'	YES/NO (&)	NO	YES ADJUST.	YES	5734	(*)
GSX-S125	17' - 20'	YES/NO (&)	NO	YES ADJUST.	YES	9958	(*)
GSX-S750	17' - 20'	YES/NO (&)	NO	YES ADJUST.	YES	9422	(*)
GSX-S1000	15' - 20'	YES/NO (&)	NO	YES ADJUST.	YES	9422	(*)
GSX-S1000F	15' - 20'	YES/NO (&)	NO	YES ADJUST.	YES	9422	(*)
GSX-R125	17' - 20'	YES/NO (&)	NO	YES ADJUST.	YES	9958	(*)
GSX-R250	17' - 20'	YES/NO (&)	NO	YES ADJUST.	YES	9523	(*)
GSX-R600	04' - 05'	NO	NO	YES	YES	1779	(*)

N
Black

(*) Check price with your distributor.
 (**) Required original piece from Yamaha ref. 150-F1685-10
 (&) Produced not adjustable with a removable fastener.
 (-) It's necessary to cut the rear fender.

IMPORTANT: Indicate code color after part#. Example 0973A

LICENSE SUPPORTS

HI-TECH PARTS

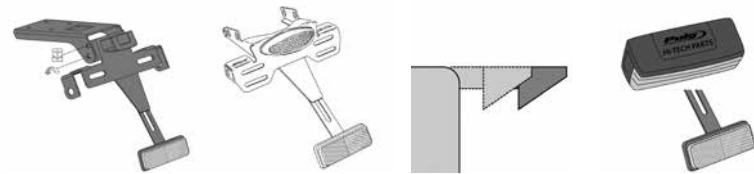
2021 MODELS: www.puig.tv

MODEL	YEAR	ADJUSTABLE	BRAKE REAR LIGHT- INCLUDED	TURN LIGHT SUPPORT	INCLUDE KIT	REF.	N
GSX-R600	06' - 07'	YES/NO (&)	NO	NO	NO	4075	(*)
GSX-R600	08' - 10'	YES/NO (&)	NO	NO	YES	4735	(*)
GSX-R600	11' - 16	YES/NO (&)	NO	NO	YES	5733	(*)
GSX-R750	04' - 05'	NO	NO	YES	YES	1779	(*)
GSX-R750	06' - 07'	YES/NO (&)	NO	NO	NO	4075	(*)
GSX-R750	08' - 10'	YES/NO (&)	NO	NO	YES	4735	(*)
GSX-R750	11' - 16'	YES/NO (&)	NO	NO	YES	5733	(*)
GSX-R1000	05' - 08'	YES/NO (&)	NO	NO	NO	2558	(*)
GSX-R1000/R	17' - 20'	YES/NO (&)	NO	YES ADJUST.	YES	9451	(*)
GSXR1300 HAYABUSA	08' - 12'	YES/NO (&)	NO	NO	YES	4817	(*)
KATANA	19' - 20'	YES/NO (&)	NO	YES	YES	3647	(*)
SV650	16' - 20'	YES/NO (&)	NO	YES ADJUST.	YES	8729	(*)
SV650X	18' - 20'	YES/NO (&)	NO	YES ADJUST.	YES	8729	(*)
TRIUMPH							
DAYTONA 675/R	13' - 17'	YES/NO (&)	NO	YES ADJUST.	YES	6551	(*)
SPEED TRIPLE	11' - 15'	YES/NO (&)	NO	YES	YES	5732	(*)
SPEED TRIPLE R	12' - 15'	YES/NO (&)	NO	YES	YES	5732	(*)
SPEED TRIPLE/R	16' - 19'	YES/NO (&)	NO	YES	YES	8730	(*)
STREET TRIPLE/R	13' - 19'	YES/NO (&)	NO	YES ADJUST.	YES	6551	(*)
STREET TRIPLE R	20'	YES/NO (&)	NO	YES ADJUST.	YES	6551	(*)
STREET TRIPLE S	17' - 20'	YES/NO (&)	NO	YES ADJUST.	YES	6551	(*)
STREET TRIPLE RS	17' - 19'	YES/NO (&)	NO	YES ADJUST.	YES	6551	(*)
YAMAHA							
FZ6	04' - 08'	YES/NO (&)	NO	YES ADJUST.	NO	5046	(*)
FZ6 FAZER	04' - 08'	YES/NO (&)	NO	YES ADJUST.	NO	5046	(*)
FZ6 FAZER S2	07' - 10'	YES/NO (&)	NO	YES ADJUST.	NO	5046	(*)
FZ6 S2	07' - 10'	YES/NO (&)	NO	YES ADJUST.	NO	5046	(*)
MT-125	15 - 19'	YES/NO (&)	NO	YES ADJUST.	YES	7796	(*)
MT-125	20'	YES/NO (&)	NO	YES ADJUST.	YES	3884	(*)
MT-03	16' - 20'	YES/NO (&)	NO	YES ADJUST.	YES	7799	(*)
MT-07	14' - 20'	YES/NO (&)	NO	YES ADJUST.	YES	7108	(*)
MT-07 TRACER	16' - 19'	YES/NO (&)	NO	YES ADJUST.	YES	9204	(*)
MT-07 TRACER	20'	YES/NO (&)	NO	YES ADJUST.	YES	9204	(*)
MT-09	13' - 16'	YES/NO (&)	NO	YES ADJUST.	YES	6885	(*)
MT-09	17' - 20'	YES/NO (&)	NO	YES ADJUST.	YES	9379	(*)
MT-09	17' - 20'	NO	NO	NO	YES	9394	(*)
MT-09 SP	18' - 20'	YES/NO (&)	NO	YES ADJUST.	YES	9379	(*)

2021 MODELS: www.puig.tv

MODEL	YEAR	ADJUSTABLE	BRAKE REAR LIGHT- INCLUDED	TURN LIGHT SUPPORT	INCLUDE KIT	REF.	N
MT-09 TRACER	15' - 20'	YES/NO (&)	NO	YES ADJUST.	YES	6885	(*)
TENERE 700	19' - 20'	YES/NO (&)	NO	YES ADJUST.	YES	3861	(*)
T-MAX 500 (-)	08' - 11'	YES/NO (&)	NO	NO	YES	4852	(*)
T-MAX 530	12' - 16'	YES/NO (&)	NO	NO	YES	6092	(*)
T-MAX 530/DX/SX	17' - 19'	YES/NO (&)	NO	YES ADJUST.	YES	9468	(*)
T-MAX 560 /SX/DX/MAX TECH	20'	YES/NO (&)	NO	YES ADJUST.	YES	3874	(*)
XJ6	09' - 16'	YES/NO (&)	NO	YES ADJUST.	YES	4949	(*)
XJ6 DIVERSION	09' - 16'	YES/NO (&)	NO	YES ADJUST.	YES	4949	(*)
XJ6 DIVERSION F	10' - 16'	YES/NO (&)	NO	YES ADJUST.	YES	4949	(*)
X-MAX 125 (**)	14' - 17'	YES/NO (&)	NO	NO	YES	6993	(*)
X-MAX 250 (**)	14' - 16'	YES/NO (&)	NO	NO	YES	6993	(*)
X-MAX 400 (**)	13' - 17'	YES/NO (&)	NO	NO	YES	6993	(*)
XSR700	16' - 20'	YES/NO (&)	YES	YES ADJUST.	YES	8733	(*)
XSR700 XTRIBUTE	19' - 20'	YES/NO (&)	YES	YES ADJUST.	YES	8733	(*)
YZF-R125	19' - 20'	YES/NO (&)	NO	YES ADJUST.	YES	3620	(*)
YZF-R1	02' - 03'	YES/NO (&)	NO	YES	YES	1611	(*)
YZF-R1/SP	04' - 06'	NO	NO	YES	NO	1762	(*)
YZF-R1	07' - 08'	YES/NO (&)	NO	YES	NO	4454	(*)
YZF-R1	15' - 20'	YES/NO (&)	NO	YES ADJUST.	YES	7798	(*)
YZF-R1M	17' - 20'	YES/NO (&)	NO	YES ADJUST.	YES	7798	(*)
YZF-R3	15' - 18'	YES/NO (&)	NO	YES ADJUST.	YES	7799	(*)
YZF-R6	03' - 05'	YES/NO (&)	NO	YES	YES	1611	(*)
YZF-R6	06' - 07'	YES/NO (&)	NO	YES	YES	4073	(*)
YZF-R6	08' - 16'	YES/NO (&)	NO	YES ADJUST.	NO	4736	(*)
YZF-R6	17' - 20'	YES/NO (&)	NO	YES ADJUST.	NO	9842	(*)

N
Black

(*) Check price with your distributor.
 (**) Required original piece from Yamaha ref. 150-F1685-10
 (&) Produced not adjustable with a removable fastener.
 (-) It's necessary to cut the rear fender.
 IMPORTANT: Indicate code color after part#. Example 0973A

LIGHTING LICENSE SUPPORT
HI-TECH PARTS



// PLA

HOMOLOGATED

MODEL	REF.	N
LICENSE LIGHT SUPPORT MODEL PLA WITH LEDS (45 x 20 mm.)	5577N	(*)

MADE IN BLACK PLASTIC SUITABLE FOR OUR LICENCE SUPPORTS.

// ALU

HOMOLOGATED

MODEL	REF.	N
LICENSE LIGHT SUPPORT MODEL ALU WITH LEDS (45 x 20 mm.)	5565	(*)

MADE IN ALUMINIUM ANODIZED SUITABLE FOR OUR LICENCE SUPPORTS.

// MIG

HOMOLOGATED

MODEL	REF.	N
LICENSE LIGHT SUPPORT MODEL MIG WITH LEDS (56 x 26 mm.)	4646N	(*)
LICENSE LIGHT SUPPORT MODEL MIG WITH LEDS (56 x 26 mm.)	3736N	(*)

MADE IN BLACK PLASTIC SUITABLE FOR OUR LICENCE SUPPORTS.

// TRO

HOMOLOGATED

MODEL	REF.	N	P
LICENSE LIGHT SUPPORT MODEL TRO WITH LEDS (56 x 26 mm.)	4645	(*)	

MADE IN ALUMINIUM ANODIZED SUITABLE FOR OUR LICENCE SUPPORTS.



N
Black

(*) Check price with your distributor.
IMPORTANT: Indicate code color after part#. Example 0973A



P
Natural Ergal



N
Black

(*) Check price with your distributor.
IMPORTANT: Indicate code color after part#. Example 0973A

SUPPORT FOR ORIGINAL TURN SIGNAL

HI-TECH PARTS | TECHNICAL SECTION

FUNCTION

They allow the assembly of the original turn signals in the PUIG license plate holders.



MATERIAL

Made of steel.
Finished with epoxy black paint.

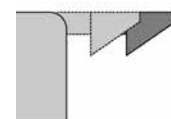

OPTICS

Hides the empty section left by the original turn signal once replaced.



REF. 9320N



N
Black

SUPPORT FOR ORIGINAL TURN SIGNAL

HI-TECH PARTS

2021 MODELS: www.puig.tv			
MODEL	YEAR	REF.	N
APRILIA			
RSV4	09' - 12'	3585N	(*)
RSV4 FACTORY	13' - 14'	3585N	(*)
RSV4 RF	15' - 20'	3585N	(*)
RSV4 RR	15' - 20'	3585N	(*)
TUONO V4R	11' - 14'	3585N	(*)
TUONO V4RR	15' - 20'	3585N	(*)
TUONO V4 1100 FACTORY	15' - 20'	3585N	(*)
BMW			
C600 SPORT	12' - 15'	3585N	(*)
C650 SPORT	16' - 20'	3585N	(*)
S1000 R	14' - 20'	3585N	(*)
S1000 RR	09' - 18'	3585N	(*)
DERBI			
GPR 125	09' - 14'	3585N	(*)
DUCATI			
MONSTER 797	17' - 20'	9604N	(*)
MONSTER 821	18' - 20'	9604N	(*)
MONSTER 1200/S	17' - 20'	9604N	(*)
PANIGALE V2	20'	9604N	(*)
PANIGALE 1100 V4	18' - 19'	9604N	(*)
PANIGALE 1100 V4S	18' - 19'	9604N	(*)
SUPERSPORT 939/S	17' - 20'	9604N	(*)
STREETFIGHTER V4/S	20'	9604N	(*)
HONDA			
CB125R NEO SPORTS CAFE	18' - 20'	9457N	(*)
CB300R NEO SPORTS CAFE	18' - 20'	9457N	(*)
CB650R NEO SPORTS CAFÉ	19' - 20'	9457N	(*)
CB500F	16' - 18'	9327N	(*)
CB500F	19' - 20'	1945N	(*)
CB600F HORNET	11' - 15'	9327N	(*)
CB650F	14' - 16'	9327N	(*)
CB650F	17' - 20'	9327N	(*)
CB1000R	08' - 16'	9327N	(*)
CB1000R NEO SPORTS CAFE	18' - 20'	1945N	(*)
CBR500R	16' - 20'	9327N	(*)
CBR650F	17' - 20'	9327N	(*)
CBR650F	14' - 16'	9327N	(*)

2021 MODELS: www.puig.tv			
MODEL	YEAR	REF.	N
CBR650R	19' - 20'	9457N	(*)
CBR1000RR FIREBLADE	04' - 07'	9327N	(*)
CBR1000RR FIREBLADE	12' - 13'	9327N	(*)
CBR1000RR FIREBLADE/SP/SP2	17' - 19'	9457N	(*)
CMX 500 REBEL	17' - 18'	9327N	(*)
CRF1100L AFRICA TWIN	20'	1945N	(*)
CRF1100L AFRICA TWIN ADVENTURE SPORTS	20'	1945N	(*)
INTEGRA 700	12' - 13'	9327N	(*)
INTEGRA 750	14' - 20'	9327N	(*)
INTEGRA 750S	14' - 16'	9327N	(*)
NC700S/X	14' - 20'	9327N	(*)
NC750S/X	14' - 20'	9327N	(*)
X-ADV	17' - 20'	9457N	(*)
KAWASAKI			
ER-6F	06' - 16'	9320N	(*)
ER-6N	05' - 16'	9320N	(*)
NINJA 125	19' - 20'	9320N	(*)
NINJA 400	18' - 20'	9320N	(*)
NINJA 650	17' - 20'	9320N	(*)
NINJA H2 SX	18' - 20'	9320N	(*)
NINJA 1000SX	20'	9320N	(*)
VERSYS-X 300	17' - 20'	9320N	(*)
VERSYS 650	10' - 20'	9320N	(*)
VERSYS 1000	12' - 20'	9320N	(*)
VULCAN S	15' - 20'	9320N	(*)
VULCAN S CAFE	17' - 20'	9320N	(*)
Z125	19' - 20'	9320N	(*)
Z250SL	15' - 16'	9320N	(*)
Z300	15' - 17'	9320N	(*)
Z400	19' - 20'	9320N	(*)
Z650	17' - 20'	9320N	(*)
Z750	04' - 12'	9320N	(*)
Z750R	11' - 12'	9320N	(*)
Z800/E	13' - 16'	9320N	(*)
Z900	17' - 20'	9320N	(*)
Z900RS	18' - 20'	9320N	(*)
Z900RS CAFÉ	18' - 20'	9320N	(*)
Z1000	03' - 19'	9320N	(*)

2021 MODELS: www.puig.tv			
MODEL	YEAR	REF.	N
Z1000R	17' - 20'	9320N	(*)
Z1000SX	11' - 20'	9320N	(*)
ZX-6R	03' - 04'	9320N	(*)
ZX-6R	18' - 20'	9320N	(*)
ZX-10R	16' - 20'	9320N	(*)
ZX-10RR	17' - 20'	9320N	(*)
ZX-10R SE	18' - 20'	9320N	(*)
KTM			
125 DUKE	17' - 20'	9324N	(*)
390 DUKE	17' - 20'	9324N	(*)
790 DUKE	18' - 20'	9324N	(*)
690 SUPERMOTO	07' - 11'	9324N	(*)
1290 SUPERDUKE R	14' - 20'	9324N	(*)
1290 SUPERDUKE GT	16' - 20'	9324N	(*)
RC125/RC390	14' - 19'	9324N	(*)
SUZUKI			
GSR750	11' - 16'	9325N	(*)
GSX-S125	17' - 20'	9959N	(*)
GSX-S750	17' - 20'	9452N	(*)
GSX-S1000	15' - 17'	9452N	(*)
GSX-S1000	18' - 20'	9325N	(*)
GSX-S1000F	18' - 20'	9325N	(*)
GSX-S1000F	15' - 17'	9452N	(*)
GSX-R125	17' - 20'	9959N	(*)
GSX-R250	17' - 20'	9524N	(*)
GSX-R1000	09' - 15'	9325N	(*)
GSX-R1000	16'	9452N	(*)
GSX-R1000/R	17' - 20'	9452N	(*)
KATANA	19'	9452N	(*)
SV650	16' - 17'	9452N	(*)
SV650	18' - 20'	9325N	(*)
SV650X	18' - 20'	9452N	(*)
TRIUMPH			
DAYTONA 675	13' - 17'	9322N	(*)
DAYTONA 675 R	13' - 17'	9322N	(*)
STREET TRIPLE	13' - 19'	9322N	(*)
STREET TRIPLE R	13' - 20'	9322N	(*)
STREET TRIPLE S	17' - 20'	9322N	(*)

2021 MODELS: www.puig.tv			
MODEL	YEAR	REF.	N
STREET TRIPLE RS	17' - 19'	9322N	(*)
YAMAHA			
FAZER8	13' - 16'	9319N	(*)
FZ1	06' - 15'	9319N	(*)
FZ1 FAZER	06' - 15'	9319N	(*)
FZ6	04' - 08'	9319N	(*)
FZ6 S2	07' - 10'	9319N	(*)
FZ6 FAZER	04' - 08'	9319N	(*)
FZ6 FAZER S2	07' - 10'	9319N	(*)
FZ8	10' - 16'	9319N	(*)
FZ8 FAZER	10' - 12'	9319N	(*)
MT-03	16' - 20'	9319N	(*)
MT-07	14' - 20'	9319N	(*)
MT-07 TRACER	16' - 20'	9319N	(*)
MT-09	13' - 16'	9319N	(*)
MT-09	17' - 20'	9319N	(*)
MT-09 SP	18' - 20'	9319N	(*)
MT-09 TRACER	18' - 20'	9319N	(*)
MT-09 TRACER GT	18' - 20'	9319N	(*)
MT-10	16' - 20'	9319N	(*)
MT-10 SP	17' - 20'	9319N	(*)
MT-125	15' - 19'	9319N	(*)
MT-125	20'	9319N	(*)
T-MAX 530/DX/SX	17' - 20'	9319N	(*)
T-MAX 560 /SX/DX/MAX TECH	20'	9319N	(*)
XJ6	09' - 16'	9319N	(*)
XSR700	16' - 20'	9319N	(*)
XSR700 XTRIBUTE	19' - 20'	9319N	(*)
XSR900	16' - 20'	9319N	(*)
YZF-R125	08' - 13'	9319N	(*)
YZF-R125	19' - 20'	9319N	(*)
YZF-R1	09' - 14'	9319N	(*)
YZF-R1	15' - 20'	9319N	(*)
YZF-R1M	17' - 20'	9319N	(*)
YZF-R3	15' - 18'	9319N	(*)
YZF-R6	06' - 07'	9319N	(*)
YZF-R6	08' - 20'	9319N	(*)



N
Black

NOTE: IT IS POSSIBLE THAT TO MOUNT THE ORIGINAL TURN SIGNALS YOU MIGHT NEED TO EXTEND THE CONNECTIONS.

(*) Check price with your distributor.

IMPORTANT: Indicate code color after part#. Example 0973A



N
Black

NOTE: IT IS POSSIBLE THAT TO MOUNT THE ORIGINAL TURN SIGNALS YOU MIGHT NEED TO EXTEND THE CONNECTIONS.

(*) Check price with your distributor.

IMPORTANT: Indicate code color after part#. Example 0973A

END TUBE FOR EXHAUST

HI-TECH PARTS | TECHNICAL SECTION



REF. 7358A



REF. 95420

MODEL	YEAR	REF.	A N O R
KYMCO			
AK550	17' - 20'	9542	(*)
YAMAHA			
T-MAX 530	12' - 16'	7358	(*)



(*) Check price with your distributor.
IMPORTANT: Indicate code color after part#. Example 0973A

TAIL LIGHTS
HI-TECH PARTS



// OVAL

HOMOLOGATED

	MODEL	REF.	N	W
1	SMILE - BRAKE TAIL LIGHT CLEAR LENS W/LED WITH LICENSE LIGHT 110 x 25 mm. 12v 1w/1w	1359W	(*)	
2	LIB - BRAKE TAIL LIGHT CLEAR LENS W/LED WITH LICENSE LIGHT 100 x 30 mm.	4818N	(*)	
3	BRAKE TAIL LIGHT CLEAR LENS W/LED WITH LICENSE LIGHT 85 x 20 mm.	6073W	(*)	
4	SMILE II - BRAKE TAIL LIGHT CLEAR LENS W/LED WITH LICENSE LIGHT 83 x 20 mm. 12v 0,1w/0,9w	6493W	(*)	
5	SHARK - BRAKE TAIL LIGHT CLEAR LENS W/LED WITH LICENSE LIGHT 83 x 20 mm. 12v 1w/1w	4605W	(*)	
6	SHARK2 - BRAKE TAIL LIGHT CLEAR LENS W/LED WITH LICENSE LIGHT 83 x 20 mm.	8635W	(*)	
7	NOUSE - BRAKE TAIL LIGHT CLEAR LENS W/LED WITH LICENSE LIGHT 100 x 40 mm. 12v 0,7w/1,4w	9313N	(*)	

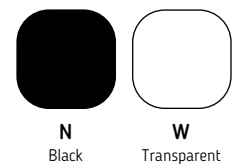

(*) Check price with your distributor.
IMPORTANT: Indicate code color after part#. Example 0973A



// ELONGATED

	MODEL	REF.	R
1	BRAKE TAIL LIGHT W/LEDS 150 x 20 mm.	(*) 0959R	(*)
2	TT - BRAKE TAIL LIGHT W/LEDS 75 x 15 mm. HOMOLOGATED	4602R	(*)

(*) These models cannot be homologated, because do not fulfill the EU standards, their C-Carbon Look use limited for tradeshows exclusively, closed exhibitions and for race tracks.

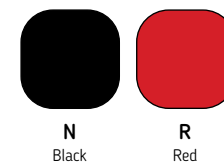

// WITH PLASTIC BASE

HOMOLOGATED

	MODEL	REF.	N
	SKIRT + BREAK LIGHT + POSITION LEDES + LICENSE PLATE POSITION LED LIGHT 12V 1W/1W	4312N	(*)



(*) Check price with your distributor.
IMPORTANT: Indicate code color after part#. Example 0973A

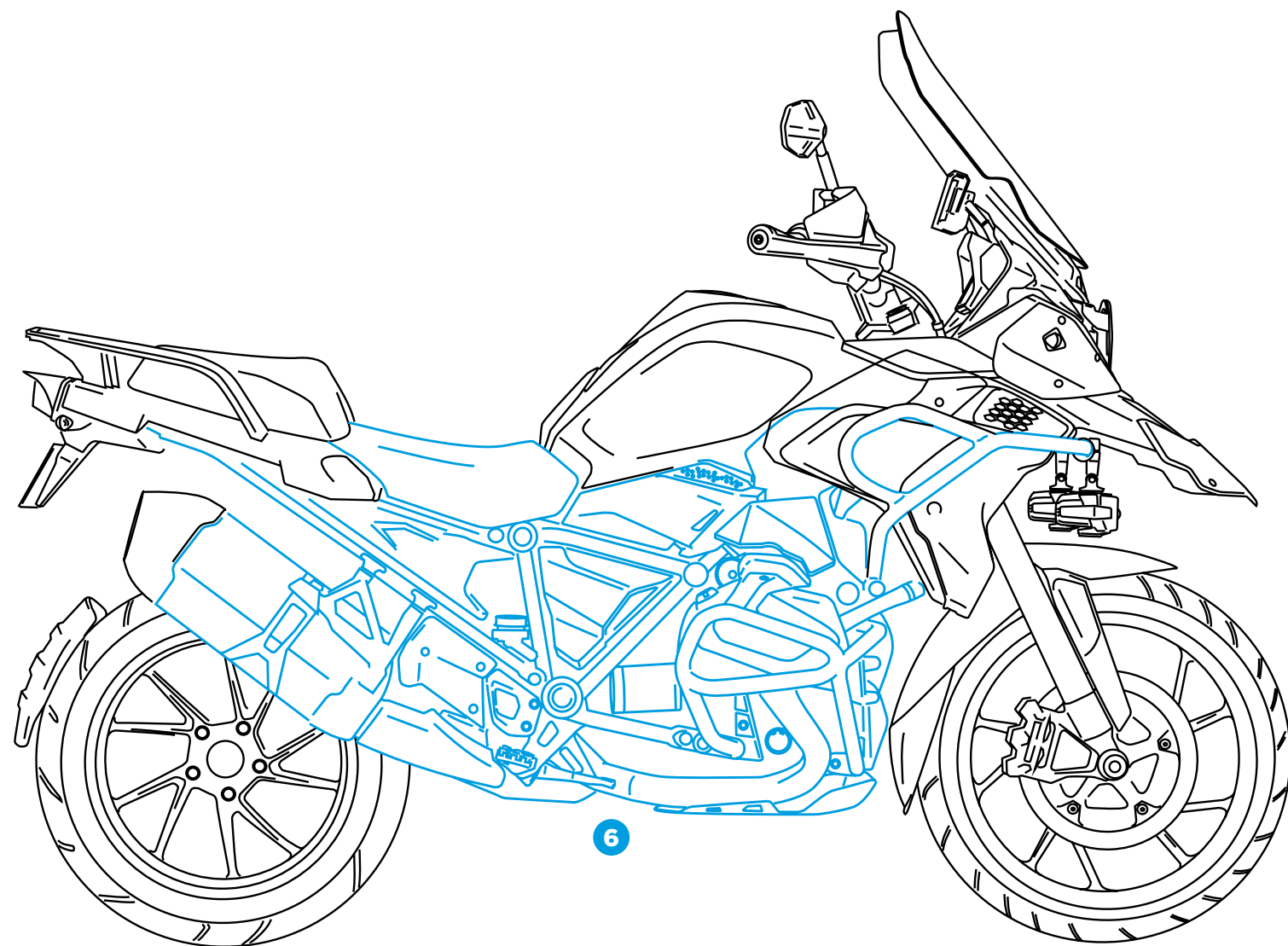

CHASSIS-ENGINE AREA

FOOTPEGS R-FIGHTER / R-FIGHTER S	393
FOOTPEGS RACING / SPORT	395
FOOTPEGS TRAIL / ENDURO	397
ALUMINIUM FILTER COVER	459
CHASSIS CAP COVERS	435
CLUTCH COVER	459
CROWN COIL	429
ENGINE GUARDS	455
ENGINE PROTECTIVE COVERS	457
ENGINE SPOILERS	431
EXHAUST PROTECTOR - DEFLECTOR	467
FOOTPEGS HARDWARE WITH RELOCATION	410
FOOTPEGS HARDWARE WITHOUT RELOCATION	401
FOOTPEGS HERITAGE	399
FRAME SLIDERS PRO MODEL	437
FRAME SLIDERS R19 MODEL	439
FRAME SLIDERS VINTAGE 2.0 MODEL	443
FRAME SLIDERS VINTAGE MODEL	441
FRONT DEFLECTOR	467
INTAKE COVER	464
KICKSTAND EXTENSION	425
PLUG-OIL CAPS	419
PLUG-OIL CAPS TRACK	421
REAR BRAKE TANK COVER	463
REAR DEFLECTORS	462

REAR HANDLES COVERS	466
REAR LUGGAGE SUPPORT COVERS	465
SHAFT COVER	428
SHOE PROTECTOR	417
SIDE PANELS	461
SPOOLS	423
SPROCKET COVER	459

R-FIGHTER / R-FIGHTER S FOOTPEGS

HI-TECH PARTS | TECHNICAL SECTION



REF. 91920



REF. 9193P



R-FIGHTER MODEL	REF.	
R-FIGHTER MODEL	9192	(*)
R-FIGHTER FOOTPEGS BY PAIR	SEE PAGE 401	
ADAPTERS BY PAIR	SEE PAGE 410	
RELOCATION BRACKETS SET 20MM	SEE PAGE 410	(*)
RELOCATION BRACKETS SET 40MM	SEE PAGE 410	(*)

R-FIGHTER S MODEL	REF.	
R-FIGHTER S FOOTPEGS BY PAIR	9193	(*)
R-FIGHTER S RUBBERS BY PAIR	9335U	(*)
ADAPTERS BY PAIR	SEE PAGE 401	
ADJUSTABLE ADAPTOR KIT	SEE PAGE 410	
RELOCATION BRACKETS SET 20MM	SEE PAGE 410	(*)
RELOCATION BRACKETS SET 40MM	SEE PAGE 410	(*)

MEASUREMENTS
74,5 x 26 mm.

DESIGN
Its design offers the best grip.

ADJUSTABLE
On inclination.

PRECISE ADJUSTER
Add marks for proper regulation.

MEASUREMENTS
74,5 x 26 mm.

DESIGN
Rubber base to reduce vibrations.

ADJUSTABLE
On inclination.

PRECISE ADJUSTER
Add marks for proper regulation.

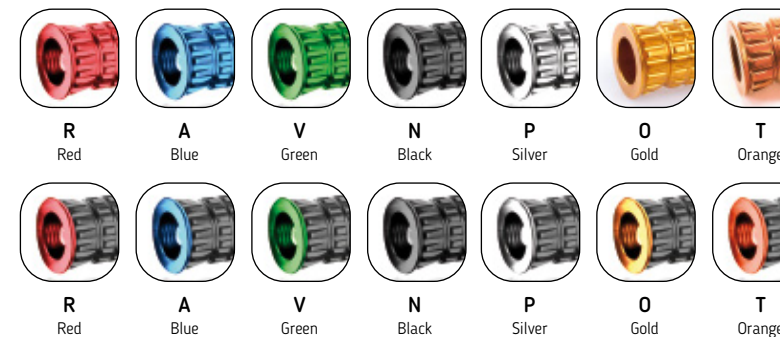

TO MOUNT PUIG FOOTPEGS, WE USE PARTS OF OEM FOOTPEGS.
FOOTPEGS FOR RIDERS: all models compatible.
FOOTPEGS FOR PASSANGER: all models compatible except trail and enduro footpegs.

(*) Check price with your distributor.
IMPORTANT: Indicate code color after part#. Example 0973A

RACING / SPORT FOOTPEGS

HI-TECH PARTS | TECHNICAL SECTION



REF. 6301V

MODEL RACING	REF.	R O A T N P V
RACING FOOTPEGS BY PAIR	6301	(*)
ADAPTERS BY PAIR	SEE PAGE 401	
ADJUSTABLE ADAPTOR KIT	SEE PAGE 410	
RELOCATION BRACKETS SET 20 mm.	SEE PAGE 410	(*)
RELOCATION BRACKETS SET 40 mm.	SEE PAGE 410	(*)

MEASUREMENTS
72 x 27 mm.

90gr.

DESIGN
Ergonomic increasing free height.

ADJUSTABLE
On inclination.

PRECISE ADJUSTER
Add marks for proper regulation.

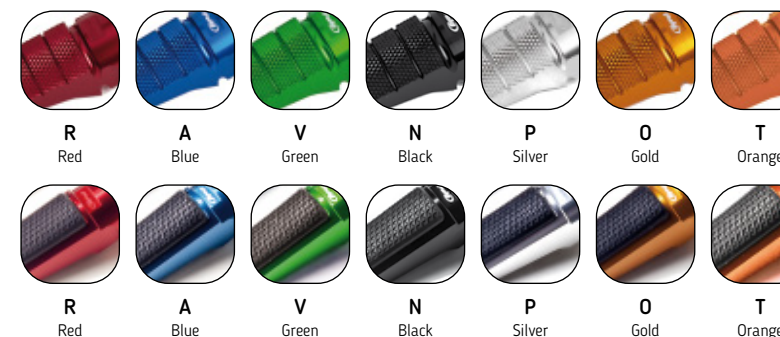

1
REF. 7318T

2
REF. 9189N

MODEL SPORT	REF.	R O A T N P V
SPORT FOOTPEGS BY PAIR (1)	7318	(*)
SPORT RUBBERS BY PAIR	7320U	(*)
VINTAGE FOOTPEGS BY PAIR (2)	9189	(*)
VINTAGE RUBBERS BY PAIR (SPARES)	9334H	(*)
ADAPTERS BY PAIR	SEE PAGE 401	
ADJUSTABLE ADAPTOR KIT	SEE PAGE 410	
RELOCATION BRACKETS SET 20MM	SEE PAGE 410	(*)
RELOCATION BRACKETS SET 40MM	SEE PAGE 410	(*)

MEASUREMENTS
72 x 27 mm.

90gr.

DESIGN
Ergonomic increasing free height.

ADJUSTABLE
On inclination.

PRECISE ADJUSTER
Add marks for proper regulation.

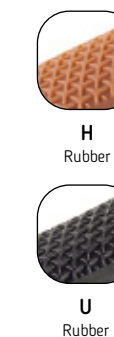

TO MOUNT PUIG FOOTPEGS, WE USE PARTS OF OEM FOOTPEGS.
FOOTPEGS FOR RIDERS: all models compatible.
FOOTPEGS FOR PASSANGER: all models compatible except trail and enduro footpegs.

(*) Check price with your distributor.
IMPORTANT: Indicate code color after part#. Example 0973A

TRAIL / ENDURO FOOTPEGS

HI-TECH PARTS | TECHNICAL SECTION



REF. 7319R



REF. 75870



MODEL TRAIL	REF.	R O A T N P V
TRAIL WITH RUBBER FOOTPEGS BY PAIR	7319	(*)
ADAPTERS BY PAIR	SEE PAGE 401	
ADJUSTABLE ADAPTOR KIT	SEE PAGE 410	
TRAIL RUBBERS BY PAIR	7321U	(*)
RELOCATION BRACKETS SET 20 mm.	SEE PAGE 410	(*)
RELOCATION BRACKETS SET 40 mm.	SEE PAGE 410	(*)

MODEL ENDURO	REF.	R O A T N P V
ENDURO WITH RUBBER FOOTPEGS BY PAIR	7587	(*)
ADAPTERS BY PAIR	SEE PAGE 401	
ADJUSTABLE ADAPTOR KIT	SEE PAGE 410	
ENDURO RUBBER BY PAIR (SPARES)	8133U	(*)
RELOCATION BRACKETS SET 20 mm.	SEE PAGE 410	(*)
RELOCATION BRACKETS SET 40 mm.	SEE PAGE 410	(*)

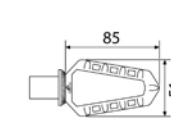

MEASUREMENTS
85 x 51 mm.



130gr.



DESIGN
Ergonomic increasing free height.



ADJUSTABLE
On inclination.



PRECISE ADJUSTER
Add marks for proper regulation.

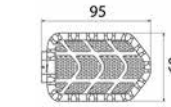

WITH OR WITHOUT
The rubbers could be removed.



440gr.



DESIGN
Ergonomic increasing free height.



ADJUSTABLE
On inclination.



PRECISE ADJUSTER
Add marks for proper regulation.



R Red A Blue V Green N Black P Silver O Gold T Orange



R Red A Blue V Green N Black P Silver O Gold T Orange



U Rubber

TO MOUNT PUIG FOOTPEGS, WE USE PARTS OF OEM FOOTPEGS.
FOOTPEGS FOR RIDERS: all models compatible.
FOOTPEGS FOR PASSANGER: all models compatible except trail and enduro footpegs.

(*) Check price with your distributor.
IMPORTANT: Indicate code color after part#. Example 0973A

HERITAGE FOOTPEGS

HI-TECH PARTS | TECHNICAL SECTION

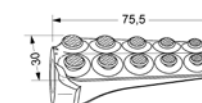

MEASUREMENTS
75,5 x 30 mm.

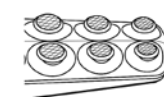

DESIGN
Ergonomic
increasing free
height.



ADJUSTABLE
On inclination.

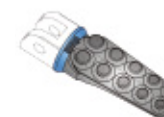

**PRECISE
ADJUSTER**
Add marks
for proper
regulation.



130gr.



N
Black



REF. 9980N

MODEL HERITAGE	REF.	N
HERITAGE FOOTPEGS BY PAIR	9980	(*)
ADAPTERS BY PAIR	SEE PAGE 401	
ADJUSTABLE ADAPTOR KIT	SEE PAGE 410	
RELOCATION BRACKETS SET 20MM	SEE PAGE 410	(*)
RELOCATION BRACKETS SET 40MM	SEE PAGE 410	(*)

TO MOUNT PUIG FOOTPEGS, WE USE PARTS OF OEM FOOTPEGS.

FOOTPEGS FOR RIDERS: all models compatible.**FOOTPEGS FOR PASSANGER:** all models compatible except trail and enduro footpegs.

(*) Check price with your distributor.

IMPORTANT: Indicate code color after part#. Example 0973A

FOOTPEGS HARDWARE

HI-TECH PARTS | TYPE OF FOOTPEGS HARDWARE:

At Puig we have developed a new range of footpeg hardware that allows the rider to adjust the position of the foot to their liking and at the same time improve their ergonomics on the bike. The image below shows you the difference between the non-adjustable footpeg hardware and the new adjustable footpeg hardware (with 20mm offset). Adjustable footpeg adaptor and standard is not the same part number.

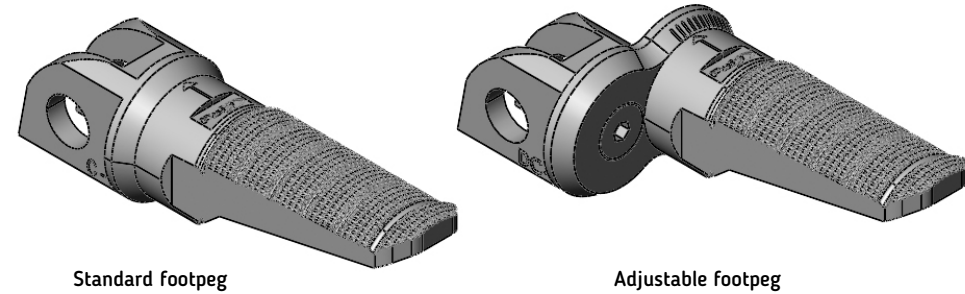

Two types of shifters are offered depending on the degree of offset desired. The 20mm displacer has been designed for rider and passenger. On the other hand, the 40mm displacer has been developed only for the passenger and especially for sports motorcycles.

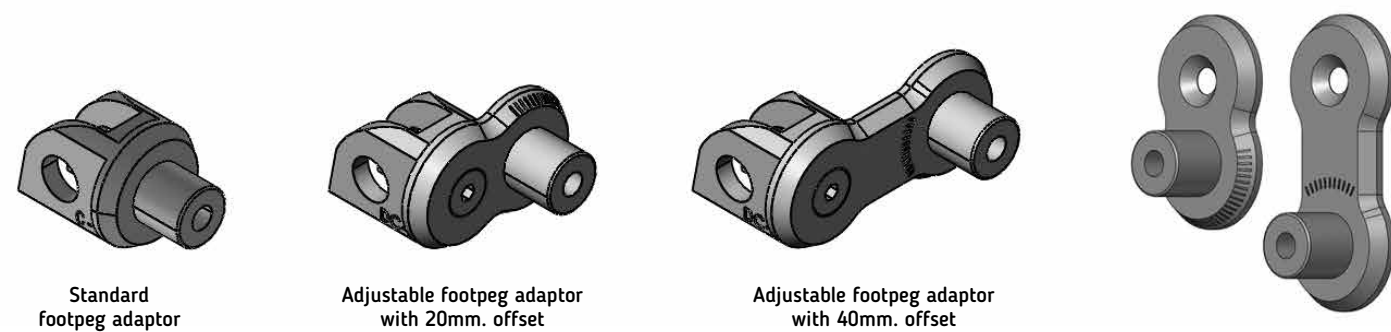

The displacer allows for both a more relaxed and sporty ride. For example, riders with small feet can move the footrest further forward for greater control. And those who prefer a sportier ride can choose to set back the footpegs. All this is possible due to the adjustment options that the displacer allows, the footrest pivots 360° in 15° intervals.

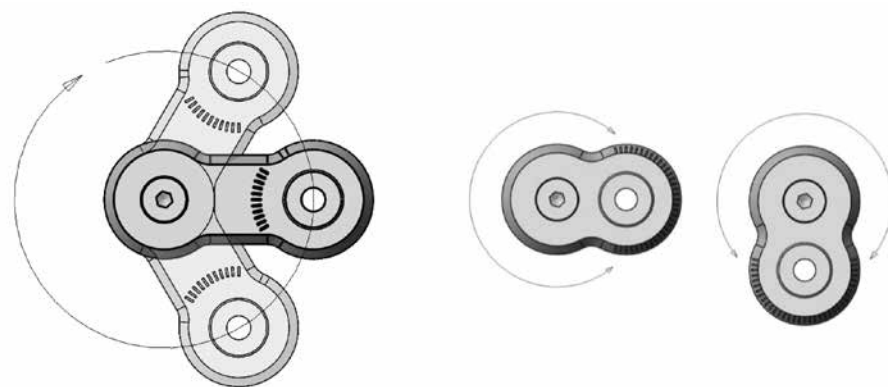

FOOTPEGS HARDWARE WITHOUT RELOCATION

HI-TECH PARTS



2021 MODELS: www.puig.tv					
MODEL	YEAR	ADAPTER BY PAIR RIDER	N	ADAPTER BY PAIR PASSENGER	N
APRILIA					
CAPONORD 1200	13' - 16	7232N	(*)	7233N	(*)
DORSODURO 900	17' - 20'	9641N	(*)	9870N	(*)
RSV4	09' - 12'	6864N	(*)	6865N	(*)
RSV4 FACTORY	13' - 14'	6864N	(*)	6865N	(*)
SHIVER 750	07' - 16'	6338N	(*)	6339N	(*)
SHIVER 900	17' - 20'	6338N	(*)	9870N	(*)
SRV850	12' - 16'			6633N	(*)
TUONO V4R	11' - 14'	6864N	(*)	6865N	(*)
BENELLI					
LEONCINO 250	20'	9696N	(*)	9697N	(*)
LEONCINO 500	16' - 20'	9696N	(*)	9697N	(*)
BMW					
C600 SPORT	12' - 14'			6341N	(*)
C600 SPORT	15'			8771N	(*)
C650 SPORT	16' - 20'			8771N	(*)
F650 GS	08' - 12'	7238N	(*)	7239N	(*)
F700 GS	12' - 17'	7238N	(*)	7239N	(*)
F750 GS	18' - 20'	7246N	(*)	9784N	(*)
F800 GT	13' - 20'			6647N	(*)
F800 GS	08' - 17'	7238N	(*)	7239N	(*)
F800 GS ADVENTURE	13' - 18'	7238N	(*)	7239N	(*)
F800 R	09' - 20'	6340N	(*)	6341N	(*)
F850 GS	18' - 20'	7246N	(*)	9784N	(*)
F850 GS ADVENTURE	19' - 20'	9471N	(*)	9784N	(*)
F900 R	20'	7200N	(*)	6647N	(*)
F900 XR	20'	7200N	(*)	6647N	(*)
G310 GS	17' - 20'	9950N	(*)	8770N	(*)
G310 R	16' - 20'	8876N	(*)	8770N	(*)
G650 GS	11' - 16'	7240N	(*)	7241N	(*)
K1200R	05' - 08'	6340N	(*)	6341N	(*)
K1300 R	09' - 16'	6340N	(*)	6341N	(*)
R1200 GS	04' - 12'	7242N	(*)	7243N	(*)



N
Black

NOTE: TO MOUNT PUIG FOOTPEGS, WE USE PARTS OF OEM FOOTPEGS.

(*) Check price with your distributor.

IMPORTANT: Indicate code color after part#. Example 0973A

FOOTPEGS HARDWARE WITHOUT RELOCATION

HI-TECH PARTS



2021 MODELS: www.puig.tv

MODEL	YEAR	ADAPTER BY PAIR RIDER	N	ADAPTER BY PAIR PASSENGER	N
R1200 GS	13' - 16'	7246N	(*)	7249N	(*)
R1200 GS	17' - 18'	7246N	(*)	7249N	(*)
R1200 GS RALLYE	17' - 18'	9471N	(*)	7249N	(*)
R1200 GS EXCLUSIVE	17' - 18'	7246N	(*)	7249N	(*)
R1200 GS ADVENTURE	06' - 13'	7248N	(*)	7245N	(*)
R1200GS ADVENTURE	14' - 18'	7248N	(*)	7249N	(*)
R1200 R	10' - 14'			6647N	(*)
R1200 R	15' - 18'	7200N	(*)	6647N	(*)
R1200 RS	15' - 18'	7200N	(*)	6647N	(*)
R1250 GS	18' - 20'	7246N	(*)	7249N	(*)
R1250 GS ADVENTURE	18' - 20'	9471N	(*)	7249N	(*)
R1250 GS HP	18' - 20'	9471N	(*)	7249N	(*)
R1250 R	19' - 20'	7200N	(*)	6647N	(*)
R1250 RS	19' - 20'	7200N	(*)	6647N	(*)
R NINE T	14' - 20'	7200N	(*)	6647N	(*)
R NINE T SCRAMBLER	16' - 20'	8877N	(*)	6647N	(*)
R NINE T PURE	17' - 20'	7200N	(*)	6647N	(*)
R NINE T RACER	17' - 20'	6866N	(*)		
R NINE T URBAN G/S	17' - 20'	8877N	(*)	6647N	(*)
S1000 R	14' - 20'	6866N	(*)	7203N	(*)
S1000 RR	09' - 20'	6866N	(*)	7203N	(*)
S1000 XR	15' - 19'	7246N	(*)	7249N	(*)
S1000 XR	20'	7200N	(*)	6647N	(*)
DUCATI					
848	08' - 13'	6997N	(*)	6997N	(*)
899 PANIGALE	14' - 15'	6997N	(*)	6997N	(*)
959 PANIGALE	16' - 19'	6997N	(*)	6997N	(*)
1199 PANIGALE	12' - 14'	6997N	(*)	6997N	(*)
1199 SUPERLEGGERA	14'	6997N	(*)	6997N	(*)
1299 PANIGALE/S	15' - 17'	6997N	(*)	6997N	(*)
PANIGALE V2	20'	6997N	(*)	6997N	(*)
PANIGALE 1100 V4	18' - 20'	6997N	(*)		
PANIGALE 1100 V4S	18' - 20'	6997N	(*)		
HYPERMOTARD 821/SP	13' - 15'	6755N	(*)	6755N	(*)
HYPERMOTARD 939/SP	16' - 18'	6755N	(*)	6755N	(*)
HYPERMOTARD 950/SP	19' - 20'	7874N	(*)	7874N	(*)
HYPERSTRADA	13' - 15'	6755N	(*)	6755N	(*)
HYPERSTRADA 939/SP	16' - 17'	8880N	(*)	8776N	(*)
MONSTER 696	08' - 14'	6342N	(*)	6342N	(*)
MONSTER 796	10' - 14'	6342N	(*)	6342N	(*)

2021 MODELS: www.puig.tv

MODEL	YEAR	ADAPTER BY PAIR RIDER	N	ADAPTER BY PAIR PASSENGER	N
MONSTER 797	17' - 20'	7874N	(*)	7874N	(*)
MONSTER 821	14' - 20'	7206N	(*)	7206N	(*)
MONSTER 1100	09' - 10'	6342N	(*)	6342N	(*)
MONSTER 1100 S	09' - 10'	6342N	(*)	6342N	(*)
MONSTER 1100 EVO	11' - 13'	6342N	(*)	6342N	(*)
MONSTER 1200/S	14' - 16'	7206N	(*)	7206N	(*)
MONSTER 1200/S	17' - 20'	7206N	(*)	7206N	(*)
MONSTER 1200 R	16' - 20'	6997N	(*)	8778N	(*)
MULTISTRADA 950	17' - 20'	9480N	(*)	9480N	(*)
MULTISTRADA 1200/ S	10' - 14'	6755N	(*)	6755N	(*)
MULTISTRADA 1200/S	15' - 17'	6755N	(*)	6755N	(*)
MULTISTRADA 1200 ENDURO/PRO	16' - 19'	8881N	(*)	8779N	(*)
MULTISTRADA 1200 PIKES PEAK	16' - 17'	6755N	(*)	6755N	(*)
MULTISTRADA 1260/S/S DJAIR	18' - 20'	9480N	(*)	9480N	(*)
MULTISTRADA 1260 PIKES PEAK	18' - 20'	9480N	(*)	9480N	(*)
SCRAMBLER 1100	18' - 20'	7206N	(*)	7874N	(*)
SCRAMBLER 1100 SPORT	18' - 20'	7206N	(*)	7874N	(*)
SCRAMBLER 1100 SPECIAL	18' - 20'	7206N	(*)	7874N	(*)
SCRAMBLER ICON/CLASSIC/FULL THROTTLE	15' - 20'	7874N	(*)	7874N	(*)
SCRAMBLER SIXTY2	16' - 20'	7874N	(*)	7874N	(*)
SCRAMBLER URBAN ENDURO	15' - 16'	7874N	(*)	7874N	(*)
SCRAMBLER FLAT TRACK PRO	16'	7874N	(*)	7874N	(*)
SCRAMBLER DESERT SLED	17' - 20'	7206N	(*)	9480N	(*)
SCRAMBLER CAFE RACER	17' - 20'	7874N	(*)	7874N	(*)
STREETFIGHTER 848	12' - 15'	6997N	(*)	6997N	(*)
STREETFIGHTER V4/S	20'	6997N	(*)	6997N	(*)
SUPERSPORT 939/S	17' - 20'	7874N	(*)	7874N	(*)
HARLEY DAVIDSON					
SPORTSTER 883 IRON	09' - 20'	9997N	(*)	9997N	(*)
HONDA					
CB125R NEO SPORTS CAFE	18' - 20'	6347N	(*)	6343N	(*)
CB300R NEO SPORTS CAFE	18' - 20'	6347N	(*)	6343N	(*)
CB500F	13' - 15'	6703N	(*)	6645N	(*)
CB500F	16' - 20'	6703N	(*)	6343N	(*)
CB500X	13' - 20'	6703N	(*)	6645N	(*)
CB600F HORNET	02' - 06'	6347N	(*)		
CB600F HORNET	07' - 15'	6347N	(*)	6448N	(*)
CB650F	14' - 20'	6347N	(*)	6343N	(*)
CB650R NEO SPORTS CAFE	19' - 20'	6347N	(*)	6343N	(*)
CB1000R NEO SPORTS CAFE	18' - 20'	6347N	(*)	6343N	(*)



N
Black

NOTE: TO MOUNT PUIG FOOTPEGS, WE USE PARTS OF OEM FOOTPEGS..

(*) Check price with your distributor.

IMPORTANT: Indicate code color after part#. Example 0973A

FOOTPEGS HARDWARE WITHOUT RELOCATION

HI-TECH PARTS



2021 MODELS: www.puig.tv

MODEL	YEAR	ADAPTER BY PAIR RIDER	N	ADAPTER BY PAIR PASSENGER	N
CB1000R	08' - 16'	6347N	(*)	6448N	(*)
CB1100	13' - 14'	6456N	(*)	6357N	(*)
CB1100RS	17' - 20'	6346N	(*)	6343N	(*)
CB1100EX	17' - 20'	6346N	(*)	6343N	(*)
CMX 500 REBEL	17' - 20'	9619N	(*)	6343N	(*)
CBF600	04' - 14'	6347N	(*)	6644N	(*)
CBF600S	08' - 14'	6347N	(*)	6644N	(*)
CBF1000	06' - 11'	6347N	(*)	6644N	(*)
CBR250R	11' - 14'	6347N	(*)	6645N	(*)
CBR500R	13' - 15'	6703N	(*)	6645N	(*)
CBR500R	16' - 20'	6703N	(*)	6343N	(*)
CBR600F	01' - 13'	6347N	(*)	6448N	(*)
CBR600RR	03' - 16'	6347N	(*)	6448N	(*)
CBR650F	14' - 19'	6347N	(*)	6343N	(*)
CBR650R	19' - 20'	6347N	(*)	6343N	(*)
CBR900RR FIRE BLADE	00' - 01'	6347N	(*)	6448N	(*)
CBR900RR FIRE BLADE	02' - 03'	6347N	(*)	6448N	(*)
CBR1000RR FIREBLADE	04' - 13'	6347N	(*)	6448N	(*)
CBR1000RR FIREBLADE/SP	14' - 16'	6347N	(*)	6448N	(*)
CBR1000RR FIREBLADE/SP/SP2	17' - 19'	6703N	(*)		
CBR1000RR FIREBLADE/SP	20'	6347N	(*)	6343N	(*)
CRF1100L AFRICA TWIN	20'	3869N	(*)	8783N	(*)
CRF1100L AFRICA TWIN ADVENTURE SPORTS	20'	3869N	(*)	8783N	(*)
CROSSRUNNER	11' - 14'	6344N	(*)	6345N	(*)
CROSSRUNNER	15' - 20'	6703N	(*)	6343N	(*)
CROSSTOURER	12' - 20'	6703N	(*)	7261N	(*)
INTEGRA 700	12' - 13'			6343N	(*)
INTEGRA 750	14' - 20'			6343N	(*)
INTEGRA 750S	14' - 16'			6343N	(*)
MSX125	14' - 20'	6347N	(*)	6345N	(*)
NC700S/X	12' - 13'	6346N	(*)	6343N	(*)
NC750S/X	14' - 15'	6346N	(*)	6343N	(*)
NC750S/X	16' - 20'	6703N	(*)	6343N	(*)
VFR800F	14' - 20'	6703N	(*)	6343N	(*)
VFR1200F	10' - 16'	6346N	(*)	6349N	(*)
VTR1000 SP-1	00' - 02'	6347N	(*)	6448N	(*)
VTR1000 SP-2	02' - 05'	6347N	(*)	6448N	(*)
X-ADV	17' - 20'	9484N	(*)		
INDIAN					
FTR 1200	19' - 20'	20465N	(*)	20466N	(*)

2021 MODELS: www.puig.tv

MODEL	YEAR	ADAPTER BY PAIR RIDER	N	ADAPTER BY PAIR PASSENGER	N
FTR 1200 S	19' - 20'	20465N	(*)	20466N	(*)
SCOUT	15' - 20'	9745N	(*)		
SCOUT BOBBER	15' - 20'	9745N	(*)		
KAWASAKI					
ER-6F	06' - 16'	6449N	(*)	6351N	(*)
ER-6N	05' - 16'	6449N	(*)	6351N	(*)
NINJA 125	19' - 20'	6449N	(*)	6451N	(*)
NINJA 250R	08' - 12'	6449N	(*)	6451N	(*)
NINJA 250SL	15' - 16'	6449N	(*)	6451N	(*)
NINJA 300	13' - 17'	6449N	(*)	6451N	(*)
NINJA 400	18' - 20'	8887N	(*)	6351N	(*)
NINJA 650	17' - 20'	6449N	(*)	6351N	(*)
NINJA 1000 SX	20'	6450N	(*)	6351N	(*)
NINJA H2 SX	18' - 20'	6450N	(*)	6351N	(*)
VERSYS-X 300	17' - 20'	6449N	(*)	6451N	(*)
VERSYS 650	10' - 20'	6449N	(*)	6351N	(*)
VERSYS 1000	12' - 20'	6449N	(*)	6351N	(*)
VULCAN S	15' - 20'	9617N	(*)	9618N	(*)
VULCAN S CAFE	17' - 20'	9617N	(*)	9618N	(*)
Z125	17' - 20'	6449N	(*)	6451N	(*)
Z250SL	15' - 16'	6449N	(*)	6451N	(*)
Z300	15' - 17'	6449N	(*)	6451N	(*)
Z400	19' - 20'	8887N	(*)	6351N	(*)
Z650	17' - 20'	6449N	(*)	6351N	(*)
Z750	04' - 12'	6450N	(*)	6351N	(*)
Z750R	11' - 12'	6677N	(*)	6351N	(*)
Z800	13' - 16'	6677N	(*)	6351N	(*)
Z800E	13' - 16'	6677N	(*)	6351N	(*)
Z900	17' - 20'	6449N	(*)	6351N	(*)
Z900RS	18' - 20'	6449N	(*)	6351N	(*)
Z900RS CAFE	18' - 20'	6449N	(*)	6351N	(*)
Z1000	03' - 09'	6450N	(*)	6351N	(*)
Z1000	10' - 13'	6677N	(*)	6351N	(*)
Z1000	14' - 20'	6677N	(*)	6351N	(*)
Z1000R	17' - 20'	6677N	(*)	6351N	(*)
Z1000SX	17' - 20'	6450N	(*)	6351N	(*)
ZX-6R	03' - 16'	6677N	(*)	6351N	(*)
ZX-6R	18' - 20'	6677N	(*)	6351N	(*)
ZX-6R 636	13' - 16'	6677N	(*)	6351N	(*)
ZX-10R	04' - 10'	6677N	(*)	6351N	(*)



N
Black

NOTE: TO MOUNT PUIG FOOTPEGS, WE USE PARTS OF OEM FOOTPEGS..

(*) Check price with your distributor.

IMPORTANT: Indicate code color after part#. Example 0973A

FOOTPEGS HARDWARE WITHOUT RELOCATION

HI-TECH PARTS



2021 MODELS: www.puig.tv

MODEL	YEAR	ADAPTER BY PAIR RIDER	N	ADAPTER BY PAIR PASSENGER	N
ZX-10R	11' - 15'	6678N	(*)	6351N	(*)
ZX-10R	16' - 20'	8887N	(*)	6351N	(*)
ZX-10RR	17' - 20'	8887N	(*)	6351N	(*)
ZX-10R SE	18' - 20'	8887N	(*)	6351N	(*)
ZZR1400	12' - 20'	6450N	(*)	6351N	(*)
KTM					
125 DUKE	11' - 16'	6338N	(*)	9520N	(*)
125 DUKE	17' - 20'	6338N	(*)	9520N	(*)
200 DUKE	12' - 15'	6338N	(*)	6770N	(*)
390 DUKE	13' - 16'	6338N	(*)	6770N	(*)
390 DUKE	17' - 20'	6338N	(*)	9520N	(*)
690 DUKE	16' - 20'	7210N	(*)	7211N	(*)
690 DUKE R	16' - 17'	7210N	(*)	7211N	(*)
790 DUKE	18' - 20'	7210N	(*)	7211N	(*)
790 ADVENTURE/R	19' - 20'	7268N	(*)	3695N	(*)
990 SUPERMOTO	08' - 13'	7268N	(*)	7269N	(*)
1050 ADVENTURE	15' - 16'	7268N	(*)	7269N	(*)
1090 ADVENTURE /R	17' - 20'	7268N	(*)	7269N	(*)
1190 ADVENTURE/R	13' - 16'	7268N	(*)	7269N	(*)
1290 SUPER ADVENTURE	15' - 16'	7268N	(*)	7269N	(*)
1290 SUPER ADVENTURE R	17' - 20'	7268N	(*)	7269N	(*)
1290 SUPER ADVENTURE S	17' - 20'	7268N	(*)	7269N	(*)
1290 SUPER ADVENTURE T	17' - 20'	7268N	(*)	7269N	(*)
1290 SUPERDUKE R	20'	20452N	(*)	20454N	(*)
RC125/RC390	14' - 20'	7210N	(*)	7211N	(*)
KYMCO					
AK 550	17' - 20'			9541N	(*)
MV AGUSTA					
BRUTALE 675	12' - 18'	6867N	(*)	6868N	(*)
BRUTALE 800/RR	13' - 18'	6867N	(*)	6868N	(*)
F3 675	12' - 20'	6867N	(*)	6868N	(*)
F4 1000	10' - 20'	6867N	(*)	6868N	(*)
TURISMO VELOCE 800/LUSSO	14' - 20'	9235N	(*)	9235N	(*)
SUZUKI					
B-KING	08' - 11'	6453N	(*)	6353N	(*)
DL250 V-STROM	17' - 20'	6453N	(*)	9963N	(*)
DL650 V-STROM	04' - 20'	6791N	(*)	7271N	(*)
DL650XT V-STROM	15' - 20'	6791N	(*)	7271N	(*)
DL1000 V-STROM	14' - 20'	6791N	(*)	7275N	(*)
DL1000XT V-STROM	17' - 20'	6791N	(*)	7275N	(*)

2021 MODELS: www.puig.tv

MODEL	YEAR	ADAPTER BY PAIR RIDER	N	ADAPTER BY PAIR PASSENGER	N
DL1050 V-STROM	20'	20405N	(*)	7275N	(*)
DL1050XT V-STROM	20'	20405N	(*)	7275N	(*)
GSR600	06' - 11'	6453N	(*)	6353N	(*)
GSR750	11' - 16'	6453N	(*)	6353N	(*)
GSX-R125	17' - 20'	6453N	(*)	9963N	(*)
GSX-R250	17' - 20'	6791N	(*)	9657N	(*)
GSX-R600	01' - 05'	6449N	(*)	6679N	(*)
GSX-R600	06' - 16'	6453N	(*)	6353N	(*)
GSX-R750	01' - 05'	6449N	(*)	6679N	(*)
GSX-R750	06' - 16'	6453N	(*)	6353N	(*)
GSX-R1000	01' - 04'	6453N	(*)	6679N	(*)
GSX-R1000	05' - 16'	6453N	(*)	6353N	(*)
GSX-R1000/R	17' - 20'	6453N	(*)	9495N	(*)
GSX-S125	17' - 20'	6453N	(*)	9963N	(*)
GSX-S750	17' - 20'	6453N	(*)	9495N	(*)
GSX-S1000	15' - 20'	6453N	(*)	7923N	(*)
GSX-S1000F	15' - 20'	6453N	(*)	7923N	(*)
INAZUMA	13' - 17'	6791N	(*)	6353N	(*)
KATANA	19' - 20'	6453N	(*)	9495N	(*)
SFV650 GLADIUS	09' - 15'	6453N	(*)	6353N	(*)
SV650S	03' - 08'	6449N	(*)	6679N	(*)
SV650	16' - 20'	6453N	(*)	6353N	(*)
SV650X	18' - 20'	6453N	(*)	6353N	(*)
SV1000S	03' - 05'	6449N	(*)	6679N	(*)
TRIUMPH					
BONNEVILLE T100/T120	16' - 19'	6797N	(*)	6798N	(*)
BONNEVILLE BOBBER	17' - 20'	6797N	(*)		
DAYTONA 675	09' - 17'	6797N	(*)	6798N	(*)
DAYTONA 675 R	11' - 17'	6797N	(*)	6798N	(*)
SCRAMBLER 1200XC	19' - 20'	7276N	(*)	6798N	(*)
SPEED TRIPLE	11' - 15'	6797N	(*)	6798N	(*)
SPEED TRIPLE/R	16' - 20'	6797N	(*)	6798N	(*)
SPEED TWIN	19' - 20'	6797N	(*)	6798N	(*)
STREET CUP	17' - 20'	6797N	(*)	6798N	(*)
STREET SCRAMBLER	17' - 20'	7276N	(*)	6798N	(*)
STREET TRIPLE	08' - 19'	6797N	(*)	6798N	(*)
STREET TRIPLE R	09' - 20'	6797N	(*)	6798N	(*)
STREET TRIPLE S	17' - 20'	6797N	(*)	6798N	(*)
STREET TRIPLE RS	17' - 19'	6797N	(*)	6798N	(*)
STREET TWIN	16' - 20'	6797N	(*)	6798N	(*)



N
Black

NOTE: TO MOUNT PUIG FOOTPEGS, WE USE PARTS OF OEM FOOTPEGS..

(*) Check price with your distributor.

IMPORTANT: Indicate code color after part#. Example 0973A

FOOTPEGS HARDWARE WITHOUT RELOCATION

HI-TECH PARTS



2021 MODELS: www.puig.tv

MODEL	YEAR	ADAPTER BY PAIR RIDER	N	ADAPTER BY PAIR PASSENGER	N
THRUXTON 1200/R	16' - 20'	6797N	(*)	6798N	(*)
TIGER 800	11' - 14'	7276N	(*)	7277N	(*)
TIGER 800 XC	11' - 14'	7276N	(*)	7277N	(*)
TIGER 800 XC/XCX/XCA	15' - 20'	7276N	(*)	7277N	(*)
TIGER 800 XR/XRX/XRT	15' - 20'	7276N	(*)	7277N	(*)
TIGER 900	20'	20386N	(*)	6798N	(*)
TIGER 900 GT	20'	20386N	(*)	6798N	(*)
TIGER 900 GT LOW	20'	20386N	(*)	6798N	(*)
TIGER 900 GT PRO	20'	20386N	(*)	6798N	(*)
TIGER 900 RALLY	20'	20386N	(*)	6798N	(*)
TIGER 900 RALLY PRO	20'	20386N	(*)	6798N	(*)
TIGER SPORT	13' - 20'	6797N	(*)	7576N	(*)
TIGER EXPLORER	12' - 15'	8796N	(*)	8798N	(*)
TIGER EXPLORER XC	13' - 15'	8796N	(*)	8798N	(*)
TIGER EXPLORER XC/XR/XRX/XRT/XCX/XCA	16' - 20'	8796N	(*)	8798N	(*)
YAMAHA					
FAZER8	13' - 16'	6455N	(*)	8183N	(*)
FJR1300A/AS	13' - 19'	6456N	(*)	6359N	(*)
FZ1	06' - 15'	6455N	(*)	6357N	(*)
FZ1 FAZER	06' - 15'	6455N	(*)	6357N	(*)
FZ6	04' - 08'	6456N	(*)	6359N	(*)
FZ6 FAZER	07' - 08'	6456N	(*)	6359N	(*)
FZ6 FAZER S2	07' - 10'	6456N	(*)	6359N	(*)
FZ8	10' - 12'	6455N	(*)	8183N	(*)
FZ8	13' - 16'	6455N	(*)	8183N	(*)
FZ8 FAZER	10' - 12'	6455N	(*)	8183N	(*)
FZS1000 FAZER	01' - 05'	6455N	(*)	6359N	(*)
MT-125	14' - 20'	6454N	(*)	6357N	(*)
MT-03	16' - 20'	6454N	(*)	6357N	(*)
MT-07	14' - 20'	6456N	(*)	6357N	(*)
MT-07 TRACER	16' - 19'	6456N	(*)	6359N	(*)
MT-07 TRACER	20'	6456N	(*)	20445N	(*)
MT-07 TRACER GT	19'	6456N	(*)	6359N	(*)
MT-09	13' - 16'	6456N	(*)	6357N	(*)
MT-09	17' - 20'	6456N	(*)	6357N	(*)
MT-09 SP	18' - 20'	6456N	(*)	6357N	(*)
MT-09 TRACER	15' - 20'	6456N	(*)	6357N	(*)
MT-09 TRACER GT	18' - 20'	6456N	(*)	6357N	(*)
MT-10	16' - 20'	8896N	(*)	6357N	(*)
MT-10 SP	17' - 20'	8896N	(*)	6357N	(*)

2021 MODELS: www.puig.tv

MODEL	YEAR	ADAPTER BY PAIR RIDER	N	ADAPTER BY PAIR PASSENGER	N
NIKEN	18' - 20'	6456N	(*)	6357N	(*)
SCR950	17' - 20'	6456N	(*)		
TENERE 700	19' - 20'	3815N	(*)	6357N	(*)
T-MAX 500	08' - 11'			6355N	(*)
T-MAX 530	12' - 14'			6355N	(*)
T-MAX 530	15' - 16'			6355N	(*)
T-MAX 530/DX/SX	17' - 19'			6357N	(*)
T-MAX 560 /SX/DX/MAX TECH	20'			6357N	(*)
XJ6	09' - 16'	6456N	(*)	6355N	(*)
XJ6 DIVERSION	09' - 16'	6456N	(*)	6355N	(*)
XJ6 DIVERSION F	10' - 16'	6456N	(*)	6355N	(*)
XV950	14' - 20'	9615N	(*)	9616N	(*)
XV950R	14' - 20'	9615N	(*)	9616N	(*)
XV950 RACER	14' - 20'	9615N	(*)	9616N	(*)
X-MAX 125	10' - 20'			6357N	(*)
X-MAX 250	10' - 16'			6357N	(*)
X-MAX 300	17' - 20'			6357N	(*)
X-MAX 400	13' - 20'			6357N	(*)
XSR700	16' - 20'	6456N	(*)	6357N	(*)
XSR700 XTRIBUTE	19' - 20'	6456N	(*)	6357N	(*)
XSR900	16' - 20'	6456N	(*)	6357N	(*)
XT660Z TÉNÉRÉ	08' - 16'	7282N	(*)	6359N	(*)
XT1200Z SUPER TÉNÉRÉ	10' - 17'	6455N	(*)		
XT1200Z SUPER TÉNÉRÉ	18' - 20'	3661N	(*)	6357N	(*)
YZF-R125	08' - 20'	6454N	(*)	6357N	(*)
YZF-R1	02' - 20'	6457N	(*)	6458N	(*)
YZF-R1M	17' - 20'	6457N	(*)	6458N	(*)
YZF-R3	15' - 20'	6454N	(*)	6357N	(*)
YZF-R6	03' - 20'	6457N	(*)	6458N	(*)



N
Black

NOTE: TO MOUNT PUIG FOOTPEGS, WE USE PARTS OF OEM FOOTPEGS..

(*) Check price with your distributor.

IMPORTANT: Indicate code color after part#. Example 0973A

FOOTPEGS HARDWARE WITH RELOCATION

HI-TECH PARTS

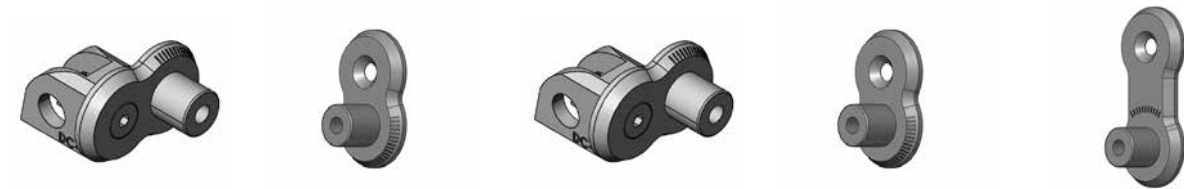

2021 MODELS: www.puig.tv

MODEL	YEAR	RIDER ADJUSTABLE ADAPTOR KIT	N	RELOCATION BRACKETS SET 20 mm	N	PASENGER ADJUSTABLE ADAPTOR KIT	N	RELOCATION BRACKETS SET 20 mm	N	RELOCATION BRACKETS SET 40 mm	N
APRILIA											
DORSODURO 900	17' - 20'					20255N	(*)	3838N	(*)	3839N	(*)
SHIVER 750	07' - 16'	20237N	(*)	3838N	(*)						
SHIVER 900	17' - 20'	20237N	(*)	3838N	(*)	20255N	(*)	3838N	(*)	3839N	(*)
BMW											
F650 GS	08' - 12'	20321N	(*)	3838N	(*)	20326N	(*)	3838N	(*)	3839N	(*)
F700 GS	12' - 17'	20321N	(*)	3838N	(*)	20326N	(*)	3838N	(*)	3839N	(*)
F750 GS	18' - 20'	20244N	(*)	3838N	(*)	20256N	(*)	3838N	(*)	3839N	(*)
F800 GT	13' - 20'					20305N	(*)	3838N	(*)	3839N	(*)
F800 GS	08' - 17'	20321N	(*)	3838N	(*)	20326N	(*)	3838N	(*)	3839N	(*)
F800 GS ADVENTURE	13' - 18'	20321N	(*)	3838N	(*)	20326N	(*)	3838N	(*)	3839N	(*)
F850 GS	18' - 20'	20244N	(*)	3838N	(*)	20256N	(*)	3838N	(*)	3839N	(*)
F850 GS ADVENTURE	19' - 20'	20247N	(*)	3838N	(*)	20256N	(*)	3838N	(*)	3839N	(*)
F900 R	20'	20304N	(*)	3838N	(*)	20305N	(*)	3838N	(*)	3839N	(*)
F900 XR	20'	20304N	(*)	3838N	(*)	20305N	(*)	3838N	(*)	3839N	(*)
R1200 GS	13' - 16'	20244N	(*)	3838N	(*)	20275N	(*)	3838N	(*)	3839N	(*)
R1200 GS	17' - 18'	20244N	(*)	3838N	(*)	20275N	(*)	3838N	(*)	3839N	(*)
R1200 GS RALLYE	17' - 18'	20247N	(*)	3838N	(*)	20275N	(*)	3838N	(*)	3839N	(*)
R1200 GS EXCLUSIVE	17' - 18'	20244N	(*)	3838N	(*)	20275N	(*)	3838N	(*)	3839N	(*)
R1200GS ADVENTURE	14' - 18'					20275N	(*)	3838N	(*)	3839N	(*)
R1200 R	15' - 18'	20304N	(*)	3838N	(*)	20305N	(*)	3838N	(*)	3839N	(*)
R1200 RS	15' - 18'	20304N	(*)	3838N	(*)	20305N	(*)	3838N	(*)	3839N	(*)
R1250 GS	18' - 20'	20244N	(*)	3838N	(*)	20275N	(*)	3838N	(*)	3839N	(*)
R1250 GS ADVENTURE	18' - 20'	20247N	(*)	3838N	(*)	20275N	(*)	3838N	(*)	3839N	(*)
R1250 GS HP	18' - 20'	20247N	(*)	3838N	(*)	20275N	(*)	3838N	(*)	3839N	(*)
R1250 R	19' - 20'	20304N	(*)	3838N	(*)	20305N	(*)	3838N	(*)	3839N	(*)
R1250 RS	19' - 20'	20304N	(*)	3838N	(*)	20305N	(*)	3838N	(*)	3839N	(*)
R NINE T	14' - 20'	20304N	(*)	3838N	(*)	20305N	(*)	3838N	(*)	3839N	(*)
R NINE T SCRAMBLER	16' - 20'					20305N	(*)	3838N	(*)	3839N	(*)
R NINE T PURE	17' - 20'	20304N	(*)	3838N	(*)	20305N	(*)	3838N	(*)	3839N	(*)
R NINE T RACER	17' - 20'	20317N	(*)	3838N	(*)						
R NINE T URBAN G/S	17' - 20'					20305N	(*)	3838N	(*)	3839N	(*)
S1000 R	14' - 20'	20317N	(*)	3838N	(*)						
S1000 RR	09' - 20'	20317N	(*)	3838N	(*)						
S1000 XR	15' - 19'	20244N	(*)	3838N	(*)	20275N	(*)	3838N	(*)	3839N	(*)
S1000 XR	20'	20304N	(*)	3838N	(*)	20305N	(*)	3838N	(*)	3839N	(*)
DUCATI											
848	08' - 13'	20324N	(*)	3838N	(*)	20324N	(*)	3838N	(*)	3839N	(*)

2021 MODELS: www.puig.tv

MODEL	YEAR	RIDER ADJUSTABLE ADAPTOR KIT	N	RELOCATION BRACKETS SET 20 mm	N	PASENGER ADJUSTABLE ADAPTOR KIT	N	RELOCATION BRACKETS SET 20 mm	N	RELOCATION BRACKETS SET 40 mm	N
899 PANIGALE	14' - 15'	20324N	(*)	3838N	(*)	20324N	(*)	3838N	(*)	3839N	(*)
959 PANIGALE	16' - 19'	20324N	(*)	3838N	(*)	20324N	(*)	3838N	(*)	3839N	(*)
1199 PANIGALE	12' - 14'	20324N	(*)	3838N	(*)	20324N	(*)	3838N	(*)	3839N	(*)
1199 SUPERLEGGERA	14'	20324N	(*)	3838N	(*)	20324N	(*)	3838N	(*)	3839N	(*)
1299 PANIGALE/S	15' - 17'	20324N	(*)	3838N	(*)	20324N	(*)	3838N	(*)	3839N	(*)
PANIGALE V2	20'	20324N	(*)	3838N	(*)	20324N	(*)	3838N	(*)	3839N	(*)
PANIGALE 1100 V4	18' - 20'	20324N	(*)	3838N	(*)						
PANIGALE 1100 V4S	18' - 20'	20324N	(*)	3838N	(*)						
HYPERMOTARD 821/SP	13' - 15'	20323N	(*)	3838N	(*)	20323N	(*)	3838N	(*)	3839N	(*)
HYPERMOTARD 939/SP	16' - 18'	20323N	(*)	3838N	(*)	20323N	(*)	3838N	(*)	3839N	(*)
HYPERMOTARD 950/SP	19' - 20'	20242N	(*)	3838N	(*)	20242N	(*)	3838N	(*)	3839N	(*)
HYPERSTRADA	13' - 15'	20323N	(*)	3838N	(*)	20323N	(*)	3838N	(*)	3839N	(*)
MONSTER 797	17' - 20'	20242N	(*)	3838N	(*)	20242N	(*)	3838N	(*)	3839N	(*)
MULTISTRADA 950	17' - 20'	20277N	(*)	3838N	(*)	20277N	(*)	3838N	(*)	3839N	(*)
MULTISTRADA 1200/ S	10' - 14'	20323N	(*)	3838N	(*)	20323N	(*)	3838N	(*)	3839N	(*)
MULTISTRADA 1200/S	15' - 17'	20323N	(*)	3838N	(*)	20323N	(*)	3838N	(*)	3839N	(*)
MULTISTRADA 1200 PIKES PEAK	16' - 17'	20323N	(*)	3838N	(*)	20323N	(*)	3838N	(*)	3839N	(*)
MULTISTRADA 1260/S/S DJAIR	18' - 20'	20277N	(*)	3838N	(*)	20277N	(*)	3838N	(*)	3839N	(*)
MULTISTRADA 1260 PIKES PEAK	18' - 20'	20277N	(*)	3838N	(*)	20277N	(*)	3838N	(*)	3839N	(*)
SCRAMBLER ICON/CLASSIC/FULL THROTTLE	15' - 20'	20242N	(*)	3838N	(*)	20242N	(*)	3838N	(*)	3839N	(*)
SCRAMBLER SIXTY2	16' - 20'	20242N	(*)	3838N	(*)	20242N	(*)	3838N	(*)	3839N	(*)
SCRAMBLER URBAN ENDURO	15' - 16'	20242N	(*)	3838N	(*)	20242N	(*)	3838N	(*)	3839N	(*)
SCRAMBLER FLAT TRACK PRO	16'	20242N	(*)	3838N	(*)	20242N	(*)	3838N	(*)	3839N	(*)
SCRAMBLER DESERT SLED	17' - 20'					20277N	(*)	3838N	(*)	3839N	(*)
SCRAMBLER CAFE RACER	17' - 20'	20242N	(*)	3838N	(*)	20242N	(*)	3838N	(*)	3839N	(*)
STREETFIGHTER 848	12' - 15'	20324N	(*)	3838N	(*)	20324N	(*)	3838N	(*)	3839N	(*)
STREETFIGHTER V4/S	20'	20324N	(*)	3838N	(*)	20324N	(*)	3838N	(*)	3839N	(*)
SUPERSPORT 939/S	17' - 20'	20242N	(*)	3838N	(*)	20242N	(*)	3838N	(*)	3839N	(*)
HONDA											
CB125R NEO SPORTS CAFE	18' - 20'	20318N	(*)	3838N	(*)	20252N	(*)	3838N	(*)	3839N	(*)
CB300R NEO SPORTS CAFE	18' - 20'	20318N	(*)	3838N	(*)	20252N	(*)	3838N	(*)	3839N	(*)
CB500F	13' - 15'	20241N	(*)	3838N	(*)	20254N	(*)	3838N	(*)	3839N	(*)
CB500F	16' - 20'	20241N	(*)	3838N	(*)	20252N	(*)	3838N	(*)	3839N	(*)
CB500X	13' - 20'	20241N	(*)	3838N	(*)	20254N	(*)	3838N	(*)	3839N	(*)
CB600F HORNET	02' - 06'	20318N	(*)	3838N	(*)						
CB600F HORNET	07' - 15'	20318N	(*)	3838N	(*)						
CB650F	14' - 20'	20318N	(*)	3838N	(*)	20252N	(*)	3838N	(*)	3839N	(*)
CB650R NEO SPORTS CAFE	19' - 20'	20318N	(*)	3838N	(*)	20252N	(*)	3838N	(*)	3839N	(*)



N
Black

NOTE: TO MOUNT PUIG FOOTPEGS, WE USE PARTS OF OEM FOOTPEGS.

(*) Check price with your distributor.

IMPORTANT: Indicate code color after part#. Example 0973A

FOOTPEGS HARDWARE WITH RELOCATION

HI-TECH PARTS

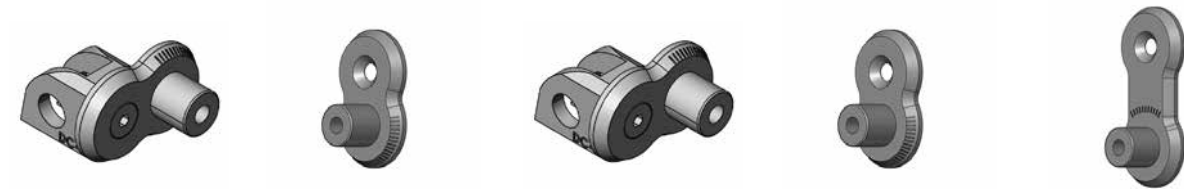

2021 MODELS: www.puig.tv

MODEL	YEAR	RIDER ADJUSTABLE ADAPTOR KIT	N	RELOCATION BRACKETS SET 20 mm	N	PASENGER ADJUSTABLE ADAPTOR KIT	N	RELOCATION BRACKETS SET 20 mm	N	RELOCATION BRACKETS SET 40 mm	N
CB1000R NEO SPORTS CAFE	18' - 20'	20318N	(*)	3838N	(*)	20252N	(*)	3838N	(*)	3839N	(*)
CB1000R	08' - 16'	20318N	(*)	3838N	(*)						
CB1100	13' - 14'	20248N	(*)	3838N	(*)	20253N	(*)	3838N	(*)	3839N	(*)
CB1100RS	17' - 20'	20236N	(*)	3838N	(*)	20252N	(*)	3838N	(*)	3839N	(*)
CB1100EX	17' - 20'	20236N	(*)	3838N	(*)	20252N	(*)	3838N	(*)	3839N	(*)
CMX 500 REBEL	17' - 20'					20252N	(*)	3838N	(*)	3839N	(*)
CBF600	04' - 14'	20318N	(*)	3838N	(*)						
CBF600S	08' - 14'	20318N	(*)	3838N	(*)						
CBF1000	06' - 11'	20318N	(*)	3838N	(*)						
CBR250R	11' - 14'	20318N	(*)	3838N	(*)	20254N	(*)	3838N	(*)	3839N	(*)
CBR500R	13' - 15'	20241N	(*)	3838N	(*)	20254N	(*)	3838N	(*)	3839N	(*)
CBR500R	16' - 20'	20241N	(*)	3838N	(*)	20252N	(*)	3838N	(*)	3839N	(*)
CBR600F	01' - 13'	20318N	(*)	3838N	(*)						
CBR600RR	03' - 16'	20318N	(*)	3838N	(*)						
CBR650F	14' - 19'	20318N	(*)	3838N	(*)	20252N	(*)	3838N	(*)	3839N	(*)
CBR650R	19' - 20'	20318N	(*)	3838N	(*)	20252N	(*)	3838N	(*)	3839N	(*)
CBR900RR FIRE BLADE	00' - 01'	20318N	(*)	3838N	(*)						
CBR900RR FIRE BLADE	02' - 03'	20318N	(*)	3838N	(*)						
CBR1000RR FIREBLADE	04' - 13'	20318N	(*)	3838N	(*)						
CBR1000RR FIREBLADE/SP	14' - 16'	20318N	(*)	3838N	(*)						
CBR1000RR FIREBLADE/SP/SP2	17' - 19'	20241N	(*)	3838N	(*)						
CBR1000RR FIREBLADE/SP	20'					20252N	(*)	3838N	(*)	3839N	(*)
CROSSRUNNER	15' - 20'	20241N	(*)	3838N	(*)	20252N	(*)	3838N	(*)	3839N	(*)
CROSSTOURER	12' - 20'	20241N	(*)	3838N	(*)						
INTEGRA 700	12' - 13'					20252N	(*)	3838N	(*)	3839N	(*)
INTEGRA 750	14' - 20'					20252N	(*)	3838N	(*)	3839N	(*)
INTEGRA 750S	14' - 16'					20252N	(*)	3838N	(*)	3839N	(*)
MSX125	14' - 20'	20318N	(*)	3838N	(*)						
NC700S/X	12' - 13'	20236N	(*)	3838N	(*)	20252N	(*)	3838N	(*)	3839N	(*)
NC750S/X	14' - 15'	20236N	(*)	3838N	(*)	20252N	(*)	3838N	(*)	3839N	(*)
NC750S/X	16' - 20'	20241N	(*)	3838N	(*)	20252N	(*)	3838N	(*)	3839N	(*)
VFR800F	14' - 20'	20241N	(*)	3838N	(*)	20252N	(*)	3838N	(*)	3839N	(*)
VFR1200F	10' - 16'	20236N	(*)	3838N	(*)						
VTR1000 SP-1	00' - 02'	20318N	(*)	3838N	(*)						
VTR1000 SP-2	02' - 05'	20318N	(*)	3838N	(*)						
KAWASAKI											
ER-6F	06' - 16'	20233N	(*)	3838N	(*)	20250N	(*)	3838N	(*)	3839N	(*)
ER-6N	05' - 16'	20233N	(*)	3838N	(*)	20250N	(*)	3838N	(*)	3839N	(*)

2021 MODELS: www.puig.tv

MODEL	YEAR	RIDER ADJUSTABLE ADAPTOR KIT	N	RELOCATION BRACKETS SET 20 mm	N	PASENGER ADJUSTABLE ADAPTOR KIT	N	RELOCATION BRACKETS SET 20 mm	N	RELOCATION BRACKETS SET 40 mm	N
NINJA 125	19' - 20'	20233N	(*)	3838N	(*)						
NINJA 250R	08' - 12'	20233N	(*)	3838N	(*)						
NINJA 250SL	15' - 16'	20233N	(*)	3838N	(*)						
NINJA 300	13' - 17'	20233N	(*)	3838N	(*)						
NINJA 400	18' - 20'	20319N	(*)	3838N	(*)	20250N	(*)	3838N	(*)	3839N	(*)
NINJA 650	17' - 20'	20233N	(*)	3838N	(*)	20250N	(*)	3838N	(*)	3839N	(*)
NINJA 1000 SX	20'	20235N	(*)	3838N	(*)	20250N	(*)	3838N	(*)	3839N	(*)
NINJA H2 SX	18' - 20'	20235N	(*)	3838N	(*)	20250N	(*)	3838N	(*)	3839N	(*)
VERSYS-X 300	17' - 20'	20233N	(*)	3838N	(*)						
VERSYS 650	10' - 20'	20233N	(*)	3838N	(*)	20250N	(*)	3838N	(*)	3839N	(*)
VERSYS 1000	12' - 20'	20233N	(*)	3838N	(*)	20250N	(*)	3838N	(*)	3839N	(*)
Z125	17' - 20'	20233N	(*)	3838N	(*)						
Z250SL	15' - 16'	20233N	(*)	3838N	(*)						
Z300	15' - 17'	20233N	(*)	3838N	(*)						
Z400	19' - 20'	20319N	(*)	3838N	(*)	20250N	(*)	3838N	(*)	3839N	(*)
Z650	17' - 20'	20233N	(*)	3838N	(*)	20250N	(*)	3838N	(*)	3839N	(*)
Z750	04' - 12'	20235N	(*)	3838N	(*)	20250N	(*)	3838N	(*)	3839N	(*)
Z750R	11' - 12'	20272N	(*)	3838N	(*)	20250N	(*)	3838N	(*)	3839N	(*)
Z800	13' - 16'	20272N	(*)	3838N	(*)	20250N	(*)	3838N	(*)	3839N	(*)
Z800E	13' - 16'	20272N	(*)	3838N	(*)	20250N	(*)	3838N	(*)	3839N	(*)
Z900	17' - 20'	20233N	(*)	3838N	(*)	20250N	(*)	3838N	(*)	3839N	(*)
Z900RS	18' - 20'	20233N	(*)	3838N	(*)	20250N	(*)	3838N	(*)	3839N	(*)
Z900RS CAFÉ	18' - 20'	20233N	(*)	3838N	(*)	20250N	(*)	3838N	(*)	3839N	(*)
Z1000	03' - 09'	20235N	(*)	3838N	(*)	20250N	(*)	3838N	(*)	3839N	(*)
Z1000	10' - 13'	20272N	(*)	3838N	(*)	20250N	(*)	3838N	(*)	3839N	(*)
Z1000	14' - 20'	20272N	(*)	3838N	(*)	20250N	(*)	3838N	(*)	3839N	(*)
Z1000R	17' - 20'	20272N	(*)	3838N	(*)	20250N	(*)	3838N	(*)	3839N	(*)
Z1000SX	17' - 20'	20235N	(*)	3838N	(*)	20250N	(*)	3838N	(*)	3839N	(*)
ZX-6R	03' - 16'	20272N	(*)	3838N	(*)	20250N	(*)	3838N	(*)	3839N	(*)
ZX-6R	18' - 20'	20272N	(*)	3838N	(*)	20250N	(*)	3838N	(*)	3839N	(*)
ZX-6R 636	13' - 16'	20272N	(*)	3838N	(*)	20250N	(*)	3838N	(*)	3839N	(*)
ZX-10R	04' - 10'	20272N	(*)	3838N	(*)	20250N	(*)	3838N	(*)	3839N	(*)
ZX-10R	11' - 15'					20250N	(*)	3838N	(*)	3839N	(*)
ZX-10R	16' - 20'	20319N	(*)	3838N	(*)	20250N	(*)	3838N	(*)	3839N	(*)
ZX-10RR	17' - 20'	20319N	(*)	3838N	(*)	20250N	(*)	3838N	(*)	3839N	(*)
ZX-10R SE	18' - 20'	20319N	(*)	3838N	(*)	20250N	(*)	3838N	(*)	3839N	(*)
ZZR1400	12' - 20'	20235N	(*)	3838N	(*)	20250N	(*)	3838N	(*)	3839N	(*)
KTM											
125 DUKE	11' - 16'	20237N	(*)	3838N	(*)						



N
Black

NOTE: TO MOUNT PUIG FOOTPEGS, WE USE PARTS OF OEM FOOTPEGS.

(*) Check price with your distributor.

IMPORTANT: Indicate code color after part#. Example 0973A

FOOTPEGS HARDWARE WITH RELOCATION

HI-TECH PARTS

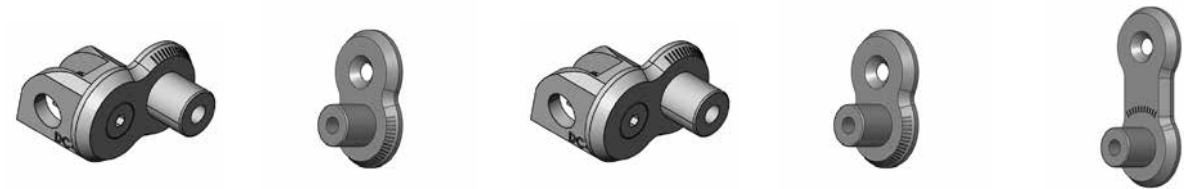

2021 MODELS: www.puig.tv

MODEL	YEAR	RIDER ADJUSTABLE ADAPTOR KIT	N	RELOCATION BRACKETS SET 20 mm	N	PASSENGER ADJUSTABLE ADAPTOR KIT	N	RELOCATION BRACKETS SET 20 mm	N	RELOCATION BRACKETS SET 40 mm	N
125 DUKE	17' - 20'	20237N	(*)	3838N	(*)						
200 DUKE	12' - 15'	20237N	(*)	3838N	(*)						
390 DUKE	13' - 16'	20237N	(*)	3838N	(*)						
390 DUKE	17' - 20'	20237N	(*)	3838N	(*)						
790 ADVENTURE/R	19' - 20'	20245N	(*)	3838N	(*)	20257N	(*)	3838N	(*)	3839N	(*)
990 SUPERMOTO	08' - 13'	20245N	(*)	3838N	(*)	20258N	(*)	3838N	(*)	3839N	(*)
1050 ADVENTURE	15' - 16'	20245N	(*)	3838N	(*)	20258N	(*)	3838N	(*)	3839N	(*)
1090 ADVENTURE /R	17' - 20'	20245N	(*)	3838N	(*)	20258N	(*)	3838N	(*)	3839N	(*)
1190 ADVENTURE/R	13' - 16'	20245N	(*)	3838N	(*)	20258N	(*)	3838N	(*)	3839N	(*)
1290 SUPER ADVENTURE	15' - 16'	20245N	(*)	3838N	(*)	20258N	(*)	3838N	(*)	3839N	(*)
1290 SUPER ADVENTURE R	17' - 20'	20245N	(*)	3838N	(*)	20258N	(*)	3838N	(*)	3839N	(*)
1290 SUPER ADVENTURE S	17' - 20'	20245N	(*)	3838N	(*)	20258N	(*)	3838N	(*)	3839N	(*)
1290 SUPER ADVENTURE T	17' - 20'	20245N	(*)	3838N	(*)	20258N	(*)	3838N	(*)	3839N	(*)
1290 SUPERDUKE R	20'	20453N	(*)	3838N	(*)	20455N	(*)	3838N	(*)	3839N	(*)
SUZUKI											
B-KING	08' - 11'	20234N	(*)	3838N	(*)						
DL250 V-STROM	17' - 20'	20234N	(*)	3838N	(*)						
DL650 V-STROM	04' - 20'	20238N	(*)	3838N	(*)						
DL650XT V-STROM	15' - 20'	20238N	(*)	3838N	(*)						
DL1000 V-STROM	14' - 20'	20238N	(*)	3838N	(*)						
DL1000XT V-STROM	17' - 20'	20238N	(*)	3838N	(*)						
DL1050 V-STROM	20'	20406N	(*)	3838N	(*)	20407N	(*)	3838N	(*)	3839N	(*)
DL1050XT V-STROM	20'	20406N	(*)	3838N	(*)	20407N	(*)	3838N	(*)	3839N	(*)
GSR600	06' - 11'	20234N	(*)	3838N	(*)						
GSR750	11' - 16'	20234N	(*)	3838N	(*)						
GSX-R125	17' - 20'	20234N	(*)	3838N	(*)						
GSX-R250	17' - 20'	20238N	(*)	3838N	(*)						
GSX-R600	01' - 05'	20233N	(*)	3838N	(*)						
GSX-R600	06' - 16'	20234N	(*)	3838N	(*)						
GSX-R750	01' - 05'	20233N	(*)	3838N	(*)						
GSX-R750	06' - 16'	20234N	(*)	3838N	(*)						
GSX-R1000	01' - 04'	20234N	(*)	3838N	(*)						
GSX-R1000	05' - 16'	20234N	(*)	3838N	(*)						
GSX-R1000/R	17' - 20'	20234N	(*)	3838N	(*)	20273N	(*)	3838N	(*)	3839N	(*)
GSX-S125	17' - 20'	20234N	(*)	3838N	(*)						
GSX-S750	17' - 20'	20234N	(*)	3838N	(*)	20273N	(*)	3838N	(*)	3839N	(*)
GSX-S1000	15' - 20'	20234N	(*)	3838N	(*)						
GSX-S1000F	15' - 20'	20234N	(*)	3838N	(*)						

2021 MODELS: www.puig.tv

MODEL	YEAR	RIDER ADJUSTABLE ADAPTOR KIT	N	RELOCATION BRACKETS SET 20 mm	N	PASSENGER ADJUSTABLE ADAPTOR KIT	N	RELOCATION BRACKETS SET 20 mm	N	RELOCATION BRACKETS SET 40 mm	N
INAZUMA	13' - 17'	20238N	(*)	3838N	(*)						
KATANA	19' - 20'	20234N	(*)	3838N	(*)	20273N	(*)	3838N	(*)	3839N	(*)
SFV650 GLADIUS	09' - 15'	20234N	(*)	3838N	(*)						
SV650S	03' - 08'	20233N	(*)	3838N	(*)						
SV650	16' - 20'	20234N	(*)	3838N	(*)						
SV650X	18' - 20'	20234N	(*)	3838N	(*)						
SV1000S	03' - 05'	20233N	(*)	3838N	(*)						
TRIUMPH											
BONNEVILLE T100/T120	16' - 19'	20320N	(*)	3838N	(*)	20325N	(*)	3838N	(*)	3839N	(*)
BONNEVILLE BOBBER	17' - 20'	20320N	(*)	3838N	(*)						
DAYTONA 675	09' - 17'	20320N	(*)	3838N	(*)	20325N	(*)	3838N	(*)	3839N	(*)
DAYTONA 675 R	11' - 17'	20320N	(*)	3838N	(*)	20325N	(*)	3838N	(*)	3839N	(*)
SCRAMBLER 1200XC	19' - 20'	20246N	(*)	3838N	(*)	20325N	(*)	3838N	(*)	3839N	(*)
SPEED TRIPLE	11' - 15'	20320N	(*)	3838N	(*)	20325N	(*)	3838N	(*)	3839N	(*)
SPEED TRIPLE/R	16' - 20'	20320N	(*)	3838N	(*)	20325N	(*)	3838N	(*)	3839N	(*)
SPEED TWIN	19' - 20'	20320N	(*)	3838N	(*)	20325N	(*)	3838N	(*)	3839N	(*)
STREET CUP	17' - 20'	20320N	(*)	3838N	(*)	20325N	(*)	3838N	(*)	3839N	(*)
STREET SCRAMBLER	17' - 20'	20246N	(*)	3838N	(*)	20325N	(*)	3838N	(*)	3839N	(*)
STREET TRIPLE	08' - 19'	20320N	(*)	3838N	(*)	20325N	(*)	3838N	(*)	3839N	(*)
STREET TRIPLE R	09' - 20'	20320N	(*)	3838N	(*)	20325N	(*)	3838N	(*)	3839N	(*)
STREET TRIPLE S	17' - 20'	20320N	(*)	3838N	(*)	20325N	(*)	3838N	(*)	3839N	(*)
STREET TRIPLE RS	17' - 19'	20320N	(*)	3838N	(*)	20325N	(*)	3838N	(*)	3839N	(*)
STREET TWIN	16' - 20'	20320N	(*)	3838N	(*)	20325N	(*)	3838N	(*)	3839N	(*)
THRUXTON 1200/R	16' - 20'	20320N	(*)	3838N	(*)	20325N	(*)	3838N	(*)	3839N	(*)
TIGER 800	11' - 14'	20246N	(*)	3838N	(*)	20259N	(*)	3838N	(*)	3839N	(*)
TIGER 800 XC	11' - 14'	20246N	(*)	3838N	(*)	20259N	(*)	3838N	(*)	3839N	(*)
TIGER 800 XC/XCX/XCA	15' - 20'	20246N	(*)	3838N	(*)	20259N	(*)	3838N	(*)	3839N	(*)
TIGER 800 XR/XRX/XRT	15' - 20'	20246N	(*)	3838N	(*)	20259N	(*)	3838N	(*)	3839N	(*)
TIGER 900	20'	20387N	(*)	3838N	(*)	20325N	(*)	3838N	(*)	3839N	(*)
TIGER 900 GT	20'	20387N	(*)	3838N	(*)	20325N	(*)	3838N	(*)	3839N	(*)
TIGER 900 GT LOW	20'	20387N	(*)	3838N	(*)	20325N	(*)	3838N	(*)	3839N	(*)
TIGER 900 GT PRO	20'	20387N	(*)	3838N	(*)	20325N	(*)	3838N	(*)	3839N	(*)
TIGER 900 RALLY	20'	20387N	(*)	3838N	(*)	20325N	(*)	3838N	(*)	3839N	(*)
TIGER 900 RALLY PRO	20'	20387N	(*)	3838N	(*)	20325N	(*)	3838N	(*)	3839N	(*)
TIGER SPORT	13' - 20'	20320N	(*)	3838N	(*)						
YAMAHA											
FJR1300A/AS	13' - 19'	20248N	(*)	3838N	(*)						
FZ1	06' - 15'					20253N	(*)	3838N	(*)	3839N	(*)
FZ1 FAZER	06' - 15'					20253N	(*)	3838N	(*)	3839N	(*)



N
Black

NOTE: TO MOUNT PUIG FOOTPEGS, WE USE PARTS OF OEM FOOTPEGS.

(*) Check price with your distributor.

IMPORTANT: Indicate code color after part#. Example 0973A

FOOTPEGS HARDWARE WITH RELOCATION

HI-TECH PARTS

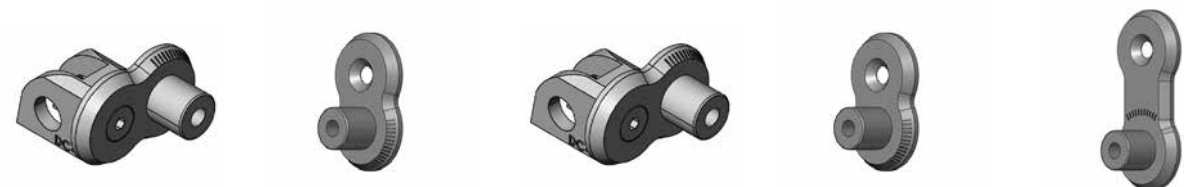

2021 MODELS: www.puig.tv

MODEL	YEAR	RIDER ADJUSTABLE ADAPTOR KIT	N	RELOCATION BRACKETS SET 20 mm	N	PASSENGER ADJUSTABLE ADAPTOR KIT	N	RELOCATION BRACKETS SET 20 mm	N	RELOCATION BRACKETS SET 40 mm	N
FZ6	04' - 08'	20248N	(*)	3838N	(*)						
FZ6 FAZER	07' - 08'	20248N	(*)	3838N	(*)						
FZ6 FAZER S2	07' - 10'	20248N	(*)	3838N	(*)						
MT-125	14' - 20'	20239N	(*)	3838N	(*)	20253N	(*)	3838N	(*)	3839N	(*)
MT-03	16' - 20'	20239N	(*)	3838N	(*)	20253N	(*)	3838N	(*)	3839N	(*)
MT-07	14' - 20'	20248N	(*)	3838N	(*)	20253N	(*)	3838N	(*)	3839N	(*)
MT-07 TRACER	16' - 19'	20248N	(*)	3838N	(*)						
MT-07 TRACER	20'	20248N	(*)	3838N	(*)	20446N	(*)	3838N	(*)	3839N	(*)
MT-07 TRACER GT	19'	20248N	(*)	3838N	(*)						
MT-09	13' - 16'	20248N	(*)	3838N	(*)	20253N	(*)	3838N	(*)	3839N	(*)
MT-09	17' - 20'	20248N	(*)	3838N	(*)	20253N	(*)	3838N	(*)	3839N	(*)
MT-09 SP	18' - 20'	20248N	(*)	3838N	(*)	20253N	(*)	3838N	(*)	3839N	(*)
MT-09 TRACER	15' - 20'	20248N	(*)	3838N	(*)	20253N	(*)	3838N	(*)	3839N	(*)
MT-09 TRACER GT	18' - 20'	20248N	(*)	3838N	(*)	20253N	(*)	3838N	(*)	3839N	(*)
MT-10	16' - 20'					20253N	(*)	3838N	(*)	3839N	(*)
MT-10 SP	17' - 20'					20253N	(*)	3838N	(*)	3839N	(*)
NIKEN	18' - 20'	20248N	(*)	3838N	(*)	20253N	(*)	3838N	(*)	3839N	(*)
SCR950	17' - 20'	20248N	(*)	3838N	(*)						
TENERE 700	19' - 20'	20243N	(*)	3838N	(*)	20253N	(*)	3838N	(*)	3839N	(*)
T-MAX 500	08' - 11'					20249N	(*)	3838N	(*)	3839N	(*)
T-MAX 530	12' - 14'					20249N	(*)	3838N	(*)	3839N	(*)
T-MAX 530	15' - 16'					20249N	(*)	3838N	(*)	3839N	(*)
T-MAX 530/DX/SX	17' - 19'					20253N	(*)	3838N	(*)	3839N	(*)
T-MAX 560 /SX/DX/MAX TECH	20'					20253N	(*)	3838N	(*)	3839N	(*)
XJ6	09' - 16'	20248N	(*)	3838N	(*)	20249N	(*)	3838N	(*)	3839N	(*)
XJ6 DIVERSION	09' - 16'	20248N	(*)	3838N	(*)	20249N	(*)	3838N	(*)	3839N	(*)
XJ6 DIVERSION F	10' - 16'	20248N	(*)	3838N	(*)	20249N	(*)	3838N	(*)	3839N	(*)
X-MAX 125	10' - 20'					20253N	(*)	3838N	(*)	3839N	(*)
X-MAX 250	10' - 16'					20253N	(*)	3838N	(*)	3839N	(*)
X-MAX 300	17' - 20'					20253N	(*)	3838N	(*)	3839N	(*)
X-MAX 400	13' - 20'					20253N	(*)	3838N	(*)	3839N	(*)
XSR700	16' - 20'	20248N	(*)	3838N	(*)	20253N	(*)	3838N	(*)	3839N	(*)
XSR700 XTRIBUTE	19' - 20'	20248N	(*)	3838N	(*)	20253N	(*)	3838N	(*)	3839N	(*)
XSR900	16' - 20'	20248N	(*)	3838N	(*)	20253N	(*)	3838N	(*)	3839N	(*)
XT1200Z SUPER TÉNÉRÉ	18' - 20'					20253N	(*)	3838N	(*)	3839N	(*)
YZF-R125	08' - 20'	20239N	(*)	3838N	(*)	20253N	(*)	3838N	(*)	3839N	(*)
YZF-R1	02' - 20'	20240N	(*)	3838N	(*)	20251N	(*)	3838N	(*)	3839N	(*)
YZF-R1M	17' - 20'	20240N	(*)	3838N	(*)	20251N	(*)	3838N	(*)	3839N	(*)

2021 MODELS: www.puig.tv

MODEL	YEAR	RIDER ADJUSTABLE ADAPTOR KIT	N	RELOCATION BRACKETS SET 20 mm	N	PASSENGER ADJUSTABLE ADAPTOR KIT	N	RELOCATION BRACKETS SET 20 mm	N	RELOCATION BRACKETS SET 40 mm	N
YZF-R3	15' - 20'	20239N	(*)	3838N	(*)	20253N	(*)	3838N	(*)	3839N	(*)
YZF-R6	03' - 20'	20240N	(*)	3838N	(*)	20251N	(*)	3838N	(*)	3839N	(*)



N
Black

NOTE: TO MOUNT PUIG FOOTPEGS, WE USE PARTS OF OEM FOOTPEGS.

(*) Check price with your distributor.

IMPORTANT: Indicate code color after part#. Example 0973A

SHOE PROTECTOR

HI-TECH PARTS | TECHNICAL SECTION



REF. 5248N

MODEL	REF.	N
PROTECTIVE SHIFT LEVER SLEEVE	5248N	(*)



N
Black

(*) Check price with your distributor.

IMPORTANT: Indicate code color after part#. Example 0973A

PLUG-OIL CAPS

HI-TECH PARTS | TECHNICAL SECTION



FIXATION

Secure with allen wrench to prevent theft.

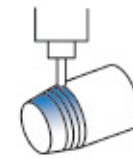

MATERIAL

Manufactured from billet aluminium.



SAFETY

Security system for track. Wire is not supplied.



WEIGHT

60 grams



TIGHTEN AND LOOSEN WITH 10 mm. SOCKET WRENCH.



REF. 6156A



R Red A Blue V Green N Black P Silver O Gold T Orange

(*) Check price with your distributor.

IMPORTANT: Indicate code color after part#. Example 0973A

Check availability for motorcycle models at www.puig.tv typing in the searching window



TRACK OIL PLUGS

HI-TECH PARTS | TECHNICAL SECTION



FIXATION

Secure with allen wrench to prevent theft.

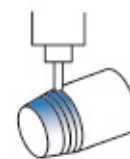

MATERIAL

Manufactured from billet aluminium.



WEIGHT

60 grams

60gr.

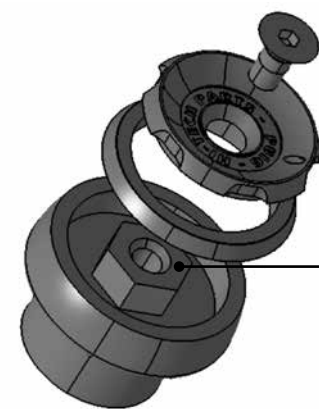

TIGHTEN AND LOOSEN
WITH 10 mm.
SOCKET WRENCH.



REF. 20342V



REF. 20340R



R

Red

A

Blue

V

Green

N

Black

P

Silver

O

Gold

T

Orange

(*) Check price with your distributor.

IMPORTANT: Indicate code color after part#. Example 0973A

Check availability for motorcycle models at www.puig.tv typing in the searching window

CAP TRACK 

SPOOLS

HI-TECH PARTS | TECHNICAL SECTION

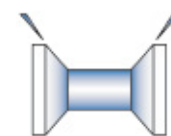

FIXATION
Fitting guide for stand support to lift up motorcycles quick and easy.

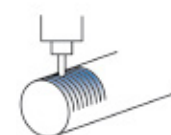

MATERIAL
Manufactured through billet aluminium and CNC machined to increase robustness.

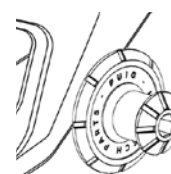

PROTECTION
The swing arm gets protected with the nylon washer added.

DESIGN
Spool and thread machined together to ease the assembly into the bike.



WEIGHT
SPOOL SLIDER
22 grams



WEIGHT
SPOOL
32 grams



WEIGHT
SPOOL PRO
40 grams

// SPOOL PRO



REF. 9259R

// SPOOL SLIDER



REF. 4033N

// SPOOL



REF. 5924O

SPOOL / SPOOL PRO



R Red A Blue N Black V Green P Silver O Gold T Orange

SPOOL SLIDER



N Black Nylon

(*) Check price with your distributor.
IMPORTANT: Indicate code color after part#. Example 0973A

Check availability for motorcycle models at www.puig.tv typing in the searching window

SPOOL

KICKSTAND EXTENSION

HI-TECH PARTS | TECHNICAL SECTION



DESIGN
Kickstand larger base extension.

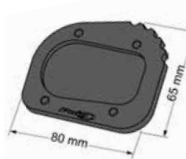

DIMENSIONS

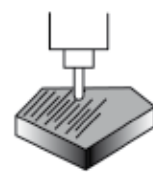

MACHINED
Machined from billet aluminium and anodized in colors.



WEIGHT
90 grams



N
Black



REF. 20219N

KICKSTAND EXTENSION

HI-TECH PARTS | TECHNICAL SECTION

2021 MODELS: www.puig.tv				
MODEL	YEAR	REF.	N	
BMW				
F800GS	08' - 20'	20187N	(*)	
F700GS	12' - 20'	20188N	(*)	
F750GS	18' - 20'	20194N	(*)	
F800GS ADVENTURE	13' - 20'	20187N	(*)	
F800GT	16' - 20'	20191N	(*)	
F800R	15' - 20'	20191N	(*)	
F850GS	18' - 20'	20194N	(*)	
F900R	20'	20418N	(*)	
F900XR	20'	20418N	(*)	
G310GS	17' - 20'	20193N	(*)	
R1200GS	04' - 12'	20186N	(*)	
R1200GS	12' - 20'	20189N	(*)	
R1200GS ADVENTURE	08' - 20'	20186N	(*)	
R1200GS LC RALLYE	16' - 20'	20189N	(*)	
R1250GS	18' - 20'	20189N	(*)	
R1250GS ADVENTURE	18' - 20'	20190N	(*)	
S1000XR	15' - 20'	20192N	(*)	
DUCATI				
HYPERSTRADA 939	16' - 20'	20208N	(*)	
HYPERMOTARD 939/SP	16' - 20'	20208N	(*)	
HYPERMOTARD 950/SP	18' - 20'	20208N	(*)	
MULTISTRADA 1200/S	15' - 20'	20208N	(*)	
MULTISTRADA 1200 ENDURO	16' - 20'	20208N	(*)	
MULTISTRADA 1260 ENDURO	17' - 20'	20208N	(*)	
MULTISTRADA 1260/S/S DJAIR	17' - 20'	20208N	(*)	
MULTISTRADA 1260 PIKES PEAK	15' - 20'	20208N	(*)	
SCRAMBLER SIXTY2	14' - 17'	20207N	(*)	
SCRAMBLER CLASSIC	14' - 17'	20207N	(*)	
SCRAMBLER FULL THROTTLE	18' - 20'	20207N	(*)	
SCRAMBLER FULL THROTTLE	14' - 17'	20208N	(*)	
SCRAMBLER FLAT TRACK PRO	14' - 17'	20207N	(*)	
SCRAMBLER ICON	18' - 20'	20207N	(*)	
SCRAMBLER ICON	14' - 17'	20208N	(*)	

2021 MODELS: www.puig.tv				
MODEL	YEAR	REF.	N	
SCRAMBLER ICON DARK	20'	20208N	(*)	
SCRAMBLER URBAN ENDURO	16' - 20'	20207N	(*)	
SCRAMBLER DESERT SLED	17' - 18'	20208N	(*)	
SCRAMBLER CAFE RACER	19' - 20'	20207N	(*)	
SCRAMBLER CAFE RACER	17' - 20'	20208N	(*)	
SCRAMBLER 1100	17' - 20'	20208N	(*)	
SCRAMBLER 1100 SPORT	17' - 20'	20208N	(*)	
SCRAMBLER 1100 SPECIAL	17' - 20'	20208N	(*)	
SUPERSPORT 939/S	17' - 20'	20208N	(*)	
HONDA				
CB125R NEO SPORTS CAFE	18' - 20'	20172N	(*)	
CB650R NEO SPORTS CAFE	19' - 20'	20172N	(*)	
CBR500R	18' - 20'	20172N	(*)	
CBR650R	18' - 20'	20172N	(*)	
CRF1000L AFRICA TWIN	15' - 20'	20173N	(*)	
CRF1000L AFRICA TWIN ADVENTURE SPORTS	18' - 19'	20173N	(*)	
CRF1100L AFRICA TWIN	20'	20281N	(*)	
CRF1100L AFRICA TWIN ADVENTURE SPORTS	20'	20281N	(*)	
CROSSRUNNER	15' - 20'	20172N	(*)	
KAWASAKI				
ER-6N	12' - 16'	20194N	(*)	
NINJA 125	18' - 20'	20195N	(*)	
NINJA 400	17' - 20'	20196N	(*)	
NINJA 650	16' - 20'	20199N	(*)	
NINJA 1000 SX	20'	20198N	(*)	
VERSYS-X 300	16' - 20'	20200N	(*)	
VERSYS 650	15' - 20'	20196N	(*)	
VERSYS 1000	15' - 20'	20197N	(*)	
Z125	18' - 20'	20195N	(*)	
Z400	18' - 20'	20196N	(*)	
Z650	17' - 20'	20198N	(*)	
Z900	17' - 20'	20198N	(*)	
KTM				
125 DUKE	11' - 20'	20174N	(*)	

2021 MODELS: www.puig.tv				
MODEL	YEAR	REF.	N	
200 DUKE	11' - 20'	20174N	(*)	
390 DUKE	13' - 20'	20174N	(*)	
790 DUKE	18' - 20'	20177N	(*)	
790 ADVENTURE /R	19'	20176N	(*)	
1050 ADVENTURE	15' - 16'	20176N	(*)	
1090 ADVENTURE / R	17' - 19'	20176N	(*)	
1190 ADVENTURE / R	13' - 16'	20176N	(*)	
1290 SUPER ADVENTURE	15' - 16'	20176N	(*)	
1290 SUPER ADVENTURE S	17' - 19'	20176N	(*)	
1290 SUPER ADVENTURE R	17' - 19'	20176N	(*)	
1290 SUPER ADVENTURE T	17' - 19'	20176N	(*)	
1290 SUPERDUKE GT	16' - 18'	20178N	(*)	
1290 SUPERDUKE GT	19' - 20'	20178N	(*)	
SUZUKI				
DL650 V-STROM	04' - 20'	20179N	(*)	
DL650XT V-STROM	15' - 20'	20179N	(*)	
DL1000 V-STROM	14' - 20'	20180N	(*)	
DL1000XT V-STROM	17' - 20'	20180N	(*)	
DL1050 V-STROM	20'	20408N	(*)	
DL1050XT V-STROM	20'	20408N	(*)	
GSX-S1000	15' - 19'	20180N	(*)	
GSX-S1000F	15' - 19'	20180N	(*)	
KATANA	19' - 20'	20180N	(*)	
TRIUMPH				
TIGER 800/XC	10' - 14'	20201N	(*)	
TIGER 800 XC / XCX / XCA	15' - 17'	20201N	(*)	
TIGER 800 XC / XCX / XCA	18' - 20'	20204N	(*)	
TIGER 800 XR / XRX / XRT	15' - 17'	20201N	(*)	
TIGER 800 XR / XRX / XRT	18' - 20'	20204N	(*)	
TIGER 900	20'	20459N	(*)	
TIGER 900 GT	20'	20459N	(*)	
TIGER 900 GT LOW	20'	20459N	(*)	
TIGER 900 GT PRO	20'	20459N	(*)	
TIGER 900 RALLY	20'	20459N	(*)	

2021 MODELS: www.puig.tv				
MODEL	YEAR	REF.	N	
TIGER 900 RALLY PRO	20'	20459N	(*)	
TIGER SPORT	13' - 20'	20203N	(*)	
TIGER EXPLORER	11' - 15'	20202N	(*)	
TIGER EXPLORER XC	11' - 15'	20202N	(*)	
TIGER EXPLORER XR / XRX / XRT	16' - 17'	20205N	(*)	
TIGER EXPLORER XR / XRT / XRX	18' - 20'	20206N	(*)	
TIGER EXPLORER XC/XCX / XCA	16' - 17'	20205N	(*)	
TIGER EXPLORER XC/XCX / XCA	18' - 20'	20206N	(*)	
YAMAHA				
NIKEN	18' - 20'	20185N	(*)	
MT-03	16' - 20'	20185N	(*)	
MT-07	14' - 20'	20183N	(*)	
MT-07 TRACER	16' - 20'	20183N	(*)	
MT-09	13' - 20'	20182N	(*)	
MT-09 SP	17' - 20'	20182N	(*)	
MT-09 TRACER	14' - 20'	20184N	(*)	
MT-09 TRACER GT	18' - 20'	20184N	(*)	
MT-10	16' - 20'	20181N	(*)	
TENERE 700	19' - 20'	20298N	(*)	
XSR 700	15' - 20'	20183N	(*)	
XSR 700 XTRIBUTE	19' - 20'	20183N	(*)	
XSR 900	15' - 20'	20184N	(*)	
YZF-R1	15' - 20'	20181N	(*)	

N
Black

(*) Check price with your distributor.

IMPORTANT: Indicate code color after part#. Example: 0973A.

N
Black

(*) Check price with your distributor.

IMPORTANT: Indicate code color after part#. Example: 0973A.



SHAFT COVER

HI-TECH PARTS | TECHNICAL SECTION

MODEL	YEAR	REF.	N
KYMCO			
AK550	17' - 19'	9543	(*)
YAMAHA			
T-MAX 530	12' - 16'	6336	(*)
T-MAX 530/DX/SX	17' - 19'	9455	(*)
T-MAX 560 /SX/DX/MAX TECH	20'	9455	(*)



REF. 6336N

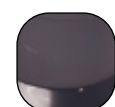

N
Black

(*) Check price with your distributor.
IMPORTANT: Indicate code color after part#. Example 0973A



CROWN COIL

HI-TECH PARTS | TECHNICAL SECTION

MODEL	YEAR	REF.	A	N	O	R	P
KYMCO							
AK550	17' - 20'	9546					(*)
YAMAHA							
T-MAX 530	12' - 16'	7359					(*)
T-MAX/DX/SX	17' - 19'	9854					(*)
T-MAX 560 /SX/DX/MAX TECH	20'	9854					(*)



REF. 7359R



A
Blue

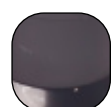

N
Black



O
Gold



R
Red



P
Silver

(*) Check price with your distributor.
IMPORTANT: Indicate code color after part#. Example 0973A

ENGINE SPOILERS

HI-TECH PARTS | TECHNICAL SECTION



// EACH BIKE MODEL HAS ITS OWN DESIGN AND STYLE, TESTED IN OUR VIRTUAL WIND TUNNEL.

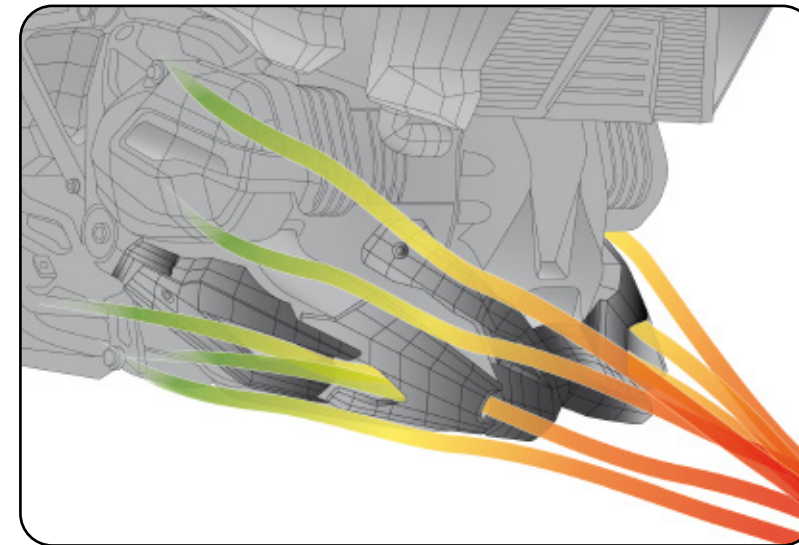

Improve stability and look.

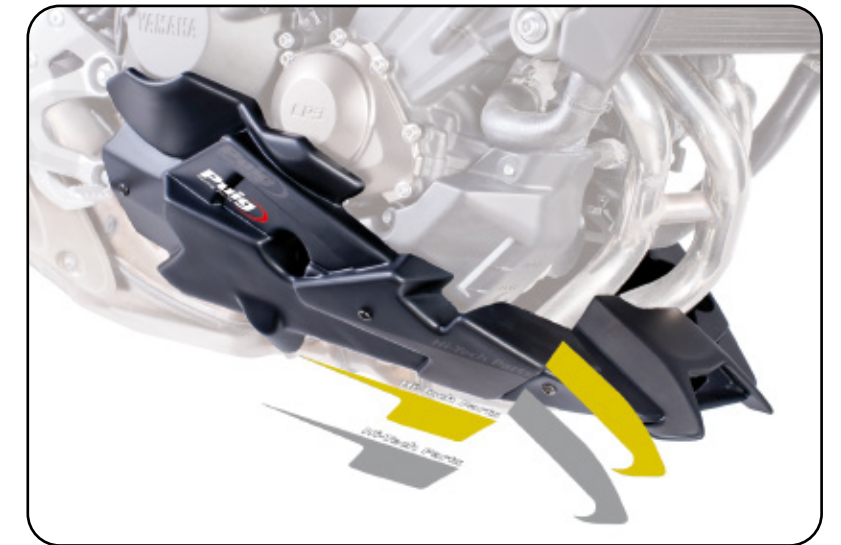

Adhesives to personalize at own taste according to bike models.

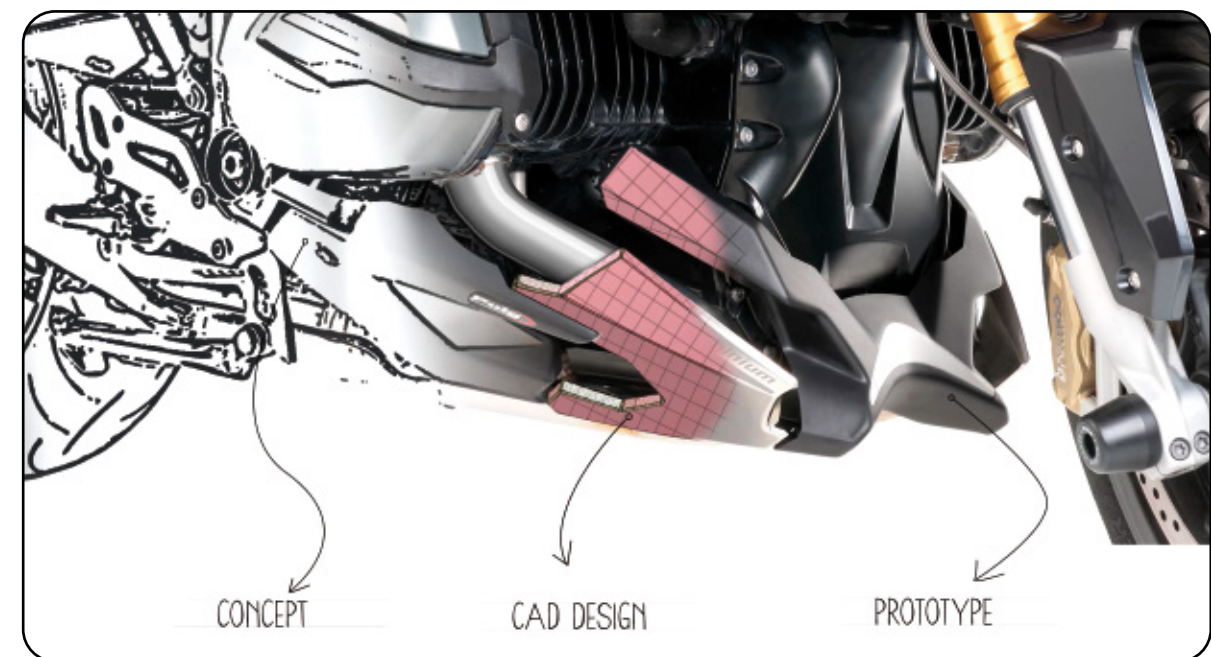

Multiple steps to a unic development.

ENGINE SPOILERS

HI-TECH PARTS

2021 MODELS: www.puig.tv

MODEL	YEAR	ADHESIVE KIT	REFERENCE	J	C
BMW					
R1200 S	06' - 08'	NOT INCLUDED	4420N	(*)	
R1200 R	15' - 18'	INCLUDED	7690	(*)	(*)
R1200 RS	15' - 18'	INCLUDED	7690	(*)	(*)
HONDA					
CB650F	14' - 18'	INCLUDED	7021	(*)	(*)
CB1000R	08' - 16'	INCLUDED	4696	(*)	(*)
CBF500	04' - 07'	NOT INCLUDED	4000N	(*)	(*)
CBF1000F	10' - 16'	NOT INCLUDED	5279	(*)	(*)
CB650R NEO SPORTS CAFÉ	19' - 20'	INCLUDED	7021	(*)	(*)
CB1000R NEO SPORTS CAFE	18' - 20'	INCLUDED	9746	(*)	(*)
KAWASAKI					
Z400	19' - 20'	NOT INCLUDED	3554	(*)	(*)
Z650	17' - 19'	INCLUDED	9589	(*)	(*)
Z650	20'	INCLUDED	20295	(*)	(*)
Z750	07' - 12'	INCLUDED	4525	(*)	(*)
Z750R	11' - 12'	INCLUDED	4525	(*)	(*)
Z800	13' - 16'	INCLUDED	6507	(*)	(*)
Z800E	13' - 16'	INCLUDED	6507	(*)	(*)
Z900	17' - 20'	INCLUDED	9703	(*)	(*)
Z1000	07' - 09'	INCLUDED	4525	(*)	(*)
KTM					
790 DUKE	18' - 20'	INCLUDED	9669	(*)	(*)
1290 SUPERDUKE R	14' - 19'	INCLUDED	7573	(*)	(*)
1290 SUPERDUKE R FOR AKRAPOVIC EXHAUST	14' - 19'	INCLUDED	7573	(*)	(*)
1290 SUPERDUKE R	20'	INCLUDED	20428	(*)	(*)
1290 SUPERDUKE GT	16' - 20'	INCLUDED	7573	(*)	(*)
SUZUKI					
DL650 V-STROM	04' - 11'	INCLUDED	8559	(*)	(*)
DL650 V-STROM	12' - 20'	INCLUDED	5896	(*)	(*)
DL650XT V-STROM	15' - 20'	INCLUDED	5896	(*)	(*)
DL1000 V-STROM	14' - 16'	INCLUDED	7231		(*)
GS500	01' - 07'	NOT INCLUDED	3997		(*)
GSF600 BANDIT	00' - 04'	INCLUDED	1689	(*)	(*)
GSF600S BANDIT	00' - 04'	INCLUDED	1689	(*)	(*)
GSF650 BANDIT	05' - 06'	INCLUDED	1689	(*)	(*)
GSF650 BANDIT	07' - 11'	INCLUDED	4415	(*)	(*)
GSF650S BANDIT	05' - 06'	INCLUDED	1689	(*)	(*)
GSF650S BANDIT	07' - 14'	INCLUDED	4415	(*)	(*)
GSF1250 BANDIT	07' - 13'	INCLUDED	4415	(*)	(*)
GSF1250S BANDIT	07' - 16'	INCLUDED	4415	(*)	(*)

2021 MODELS: www.puig.tv

MODEL	YEAR	ADHESIVE KIT	REFERENCE	J	C
GSR750	07' - 16'	INCLUDED	5682	(*)	(*)
SV650	99' - 02'	INCLUDED	8559	(*)	(*)
SV650	16' - 20'	INCLUDED	8559	(*)	(*)
SV650/S	03' - 08'	INCLUDED	8559	(*)	(*)
SV650X	18' - 20'	INCLUDED	8559	(*)	(*)
YAMAHA					
FZ1/FAZER	06' - 15'	NOT INCLUDED	4135	(*)	(*)
MT-07 - WITH ORIGINAL EXHAUST	14' - 20'	INCLUDED	7022	(*)	(*)
MT-07 - WITH AKRAPOVIC EXHAUST	14' - 20'	INCLUDED	7022	(*)	(*)
MT-07 - WITH ARROW EXHAUST	14' - 20'	INCLUDED	7022	(*)	(*)
MT-07 TRACER -WITH ORIGINAL EXHAUST	16' - 19'	INCLUDED	7022	(*)	(*)
MT-07 TRACER - WITH AKRAPOVIC EXHAUST	16' - 19'	INCLUDED	7022	(*)	(*)
MT-07 TRACER GT - WITH ORIGINAL EXHAUST	19'	INCLUDED	7022	(*)	(*)
MT-07 TRACER GT - WITH AKRAPOVIC EXHAUST	19'	INCLUDED	7022	(*)	(*)
MT-09 - WITH ORIGINAL EXHAUST	13' - 20'	INCLUDED	7692	(*)	(*)
MT-09 - WITH AKRAPOVIC EXHAUST	13' - 20'	INCLUDED	7540	(*)	(*)
MT-09 SP - WITH ORIGINAL EXHAUST	18' - 20'	INCLUDED	7692	(*)	(*)
MT-09 SP - WITH AKRAPOVIC EXHAUST	18' - 20'	INCLUDED	7540	(*)	(*)
MT-09 TRACER - WITH ORIGINAL EXHAUST	15' - 20'	INCLUDED	7692	(*)	(*)
MT-09 TRACER - WITH AKRAPOVIC EXHAUST	15' - 20'	INCLUDED	7540	(*)	(*)
MT-09 TRACER GT - WITH ORIGINAL EXHAUST	18' - 20'	INCLUDED	7692	(*)	(*)
MT-09 TRACER GT - WITH AKRAPOVIC EXHAUST	18' - 20'	INCLUDED	7540	(*)	(*)
MT-10	16' - 20'	INCLUDED	8560		(*)
MT-10 SP	17' - 20'	INCLUDED	8560		(*)

J
Matt blackC
Carbon look

ATTENTION: PREVIOUSLY VERIFY ANY INTERFERENCE BETWEEN OUR PRODUCT AND ANY OTHER ACCESSORY (OEM OR AFTERMARKET) ALREADY INSTALLED ON THE MOTORCYCLE.

(*) Check price with your distributor.

IMPORTANT: Indicate code color after part#. Example 0973A

CHASSIS CAP COVERS

HI-TECH PARTS | TECHNICAL SECTION

2021 MODELS: www.puig.tv

MODEL	YEAR	REF.	N
BENELLI			
LEONCINO 500	15' - 20'	3520	(*)
LEONCINO TRIAL	15' - 20'	3520	(*)
BMW			
F750GS	18' - 20'	0096	(*)
F850GS	18' - 20'	0096	(*)
R1200GS	13' - 18'	9332	(*)
R1200GS EXCLUSIVE	17'	9332	(*)
R1200GS RALLYE	17'	9332	(*)
R1200GS ADVENTURE	13' - 18'	9332	(*)
R1200R	15' - 18'	9333	(*)
R1200RS	15' - 18'	9333	(*)
R1200RT	14' - 18'	0327	(*)
R1200GS	13' - 18'	3521	(*)
R1250GS	19' - 20'	9332	(*)
R1250GS ADVENTURE	19' - 20'	9332	(*)
R1250RT	19' - 20'	0327	(*)
R1250R	19' - 20'	9333	(*)
R1250RS	19' - 20'	9333	(*)
R NINE T	17' - 20'	9664	(*)
R NINE T PURE	17' - 20'	9664	(*)
R NINE T RACER	17' - 20'	9664	(*)
R NINE T URBAN G/S	17' - 20'	9664	(*)
R NINE T SCRAMBLER	17' - 20'	9664	(*)
DUCATI			
DIAVEL	11' - 20'	9611	(*)



2 FUNCTIONALITIES

Cover hollow areas of the chassis and improves look of the bike.

2021 MODELS: www.puig.tv			
MODEL	YEAR	REF.	N
899 PANIGALE	13' - 15'	9631	(*)
959 PANIGALE	16' - 20'	9631	(*)
MONSTER 797	17' - 20'	9632	(*)
MONSTER 821	14' - 16'	9633	(*)
MONSTER 1200/S	14' - 16'	9633	(*)
HYPERMOTARD 939	16' - 20'	9634	(*)
HYPERSTRADA 939/SP	16' - 20'	9634	(*)
MULTISTRADA 1200/ S	10' - 14'	9635	(*)
MULTISTRADA 1200/S	15' - 20'	9636	(*)
MULTISTRADA 1200 PIKES PEAK	15' - 20'	9636	(*)
MULTISTRADA 1200 ENDURO/PRO	15' - 20'	9636	(*)
SCRAMBLER ICON/CLASSIC/FULL THROTTLE	15' - 20'	9632	(*)
SCRAMBLER SIXTY2	15' - 20'	9632	(*)
SCRAMBLER URBAN ENDURO	15' - 20'	9632	(*)
SCRAMBLER FLAT TRACK PRO	15' - 20'	9632	(*)
SCRAMBLER DESERT SLED	15' - 20'	9632	(*)
SCRAMBLER CAFE RACER	15' - 20'	9632	(*)
SCRAMBLER 1100	18' - 20'	3522	(*)
X DIAVEL/S	16' - 20'	9705	(*)
HONDA			
CB125R NEO SPORTS CAFE	18' - 20'	9801	(*)
CB300R NEO SPORTS CAFE	18' - 20'	9801	(*)
CB1000R NEO SPORTS CAFE	18' - 20'	9809	(*)
MONKEY 125	18' - 20'	3523	(*)
KAWASAKI			
NINJA 400	18' - 20'	9796	(*)
NINJA 650	17' - 20'	9637	(*)
VERSYS 1000	12' - 20'	3509	(*)
Z650	17' - 20'	9637	(*)
Z900	17' - 20'	9777	(*)
Z900RS	18' - 20'	9778	(*)
KTM			
1290 SUPERDUKE R	16' - 20'	9787	(*)
1290 SUPERDUKE GT	16' - 20'	9787	(*)
SUZUKI			
DL250 V-STROM	18' - 20'	3524	(*)
DL650 V-STROM	12' - 20'	3893	(*)
YAMAHA			
MT-07	13' - 20'	9638	(*)
MT-07 TRACER	16' - 20'	9638	(*)
TENERE 700	19' - 20'	3713	(*)
XSR700	15' - 20'	9638	(*)



N
Black

(*) Check price with your distributor.

IMPORTANT: Indicate code color after part#. Example 0973A

FRAME SLIDERS PRO MODEL

HI-TECH PARTS | TECHNICAL SECTION

BODY

Nylon pucks in black colour.



Avoid knee injuries.



DESIGN

Sliders do not stand out from handlebar and touch after the footpegs.

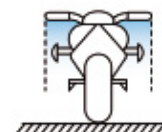

COMPLETE PROTECTION

Protect engine and chassis.

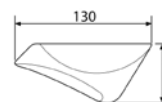

DIMENSIONS

// RUBBER END

Available in different colors.

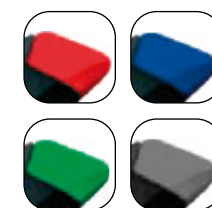

REF. 6068N + 5533R

SPARES		REF.	A	P	R	V	N
RUBBER END BY PAIR C/BLUE	5533	(*)					
RUBBER END BY PAIR C/GREY	5533	(*)					
RUBBER END BY PAIR C/RED	5533	(*)					
RUBBER END BY PAIR C/GREEN	5533	(*)					
LID SET WITH LOGO C/BLACK	5534	(*)					
NYLON PUCKS BY PAIR FOR SCREW M10	5536	(*)					
NYLON PUCKS BY PAIR FOR SCREW M12	20354	(*)					

(*) Check price with your distributor.

IMPORTANT: Indicate code color after part#. Example 0973A

FOR SPECIFIC MODELS SEE PAGE 444.

FRAME SLIDERS R19 MODEL

HI-TECH PARTS | TECHNICAL SECTION

BODY

Nylon pucks in black colour.



RUBBER

Protects rider's knee from possible hits while getting on the bike.
Supplied in grey color.

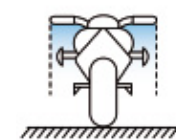

DESIGN

Sliders do not stand out from handlebar and touch after the footpegs



COMPLETE PROTECTION

Protect engine and chassis.

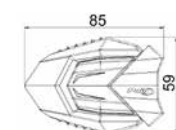

DIMENSIONS

// RUBBER ENDS AVAILABLE IN VARIOUS COLORS

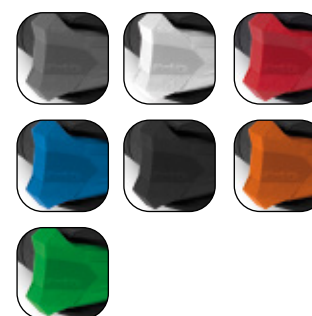

REF. 9355N

SPARE RUBBERS	REF.	U	B	R	V	A	N	T
RUBBER END PROTECTOR R19 BY PAIR	3148							

SPARES PUCKS	REF.	PRICE
NYLON PUCKS + RUBBER END C/GREY BY PAIR MOD. R19 OF 85 mm. FOR SCREW M10	3149	(*)
NYLON PUCKS + RUBBER END C/GREY BY PAIR MOD. R19 OF 85 mm. FOR SCREW M12	3150	(*)
NYLON PUCKS + RUBBER END C/GREY BY PAIR MOD. R19 OF 50 mm. FOR SCREW M10	3151	(*)
NYLON PUCKS + RUBBER END C/GREY BY PAIR MOD. R19 OF 50 mm. FOR SCREW M12	3152	(*)

SPARES VINTAGE 2.0.	REF.	PRICE
NYLON PUCK FOR M10 BOLT (COMPATIBEL WITH R19 PUCKS)	3153	(*)
NYLON PUCK FOR M12 BOLT (COMPATIBEL WITH R19 PUCKS)	3154	(*)
RUBBER END PROTECTOR VINTAGE 2.0. BY PAIR	3667	(*)

(*) Check price with your distributor.

IMPORTANT: Indicate code color after part#. Example 0973A

FOR SPECIFIC MODELS SEE PAGE 444.

FRAME SLIDERS VINTAGE MODEL

HI-TECH PARTS | TECHNICAL SECTION

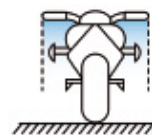

DESIGN

Sliders do not stand out from handlebar and touch after the footpegs



COMPLETE PROTECTION

Protect engine and chassis.



DIMENSIONS



N
Black



SPARES	REFERENCE	N
NYLON PUCK FOR M10 BOLT	9562	(*)
NYLON PUCK FOR M12 BOLT	9563	(*)

(*) Check price with your distributor.

IMPORTANT: Indicate code color after part#. Example 0973A

FOR SPECIFIC MODELS SEE PAGE 444.

FRAME SLIDERS VINTAGE 2.0 MODEL

HI-TECH PARTS | TECHNICAL SECTION

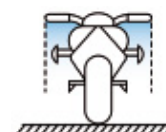

DESIGN

Sliders do not stand out from handlebar and touch after the footpegs



COMPLETE PROTECTION

Protect engine and chassis.



DIMENSIONS

// RUBBER ENDS AVAILABLE IN VARIOUS COLORS



REF. 20390N-3667A



SPARES	REFERENCE	PRICE
NYLON PUCK FOR M10 BOLT (COMPATIBEL WITH R19 PUCKS)	3153	(*)
NYLON PUCK FOR M12 BOLT (COMPATIBEL WITH R19 PUCKS)	3154	(*)
RUBBER END PROTECTOR VINTAGE 2.0. BY PAIR	3667	(*)

(*) Check price with your distributor.

IMPORTANT: Indicate code color after part#. Example 0973A

FOR SPECIFIC MODELS SEE PAGE 444.

FRAME SLIDERS

HI-TECH PARTS | TYPE OF FRAME SLIDERS:

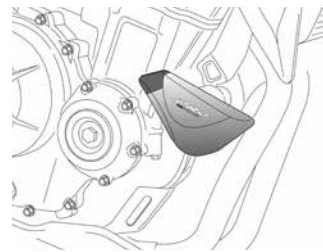

FRAME SLIDER PRO

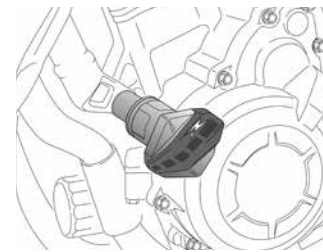

FRAME SLIDER R19



FRAME SLIDER VINTAGE

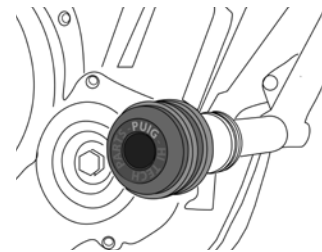

FRAME SLIDER VINTAGE 2.0.

2021 MODELS: www.puig.tv

MODEL	YEAR	TYPE OF FRAME SLIDER	REFERENCE	N
APRILIA				
DORSODURO 750	08' - 16'	R19	4706	(*)
DORSODURO 900	17' - 20'	R19	4706	(*)
DORSODURO 1200	11' - 16'	R19	4706	(*)
MANA 850	08' - 12'	R12	5891	(*)
RSV4	09' - 12'	PRO	3158	(*)
RSV4	09' - 12'	R12	5578	(*)
RSV4 FACTORY	13' - 14'	PRO	3158	(*)
RSV4 R	13' - 14'	PRO	3158	(*)
RSV4 RF	15' - 16'	PRO	3158	(*)
RSV4 RF	17' - 20'	PRO	3158	(*)
RSV4 RR	15' - 16'	PRO	3158	(*)
RSV4 RR	17' - 20'	PRO	3158	(*)
SHIVER 750	07' - 16'	R19	4706	(*)
SHIVER 900	17' - 20'	R19	4706	(*)
SHIVER GT	08' - 16'	R19	4706	(*)
TUONO V4R	11' - 14'	PRO	3158	(*)
TUONO V4 1100 RR	15' - 16'	PRO	3158	(*)
TUONO V4 1100 FACTORY	15' - 16'	PRO	3158	(*)
BENELLI				
BN 251	15' - 16'	R12	3511	(*)
BN 302	14' - 20'	R19	8106	(*)
BN 302S	19' - 20'	R19	8106	(*)
LEONCINO 250	20'	VINTAGE 2.0.	20390	(*)
LEONCINO 500	16' - 20'	R19	9693	(*)
LEONCINO 500	16' - 20'	VINTAGE 2.0.	20423	(*)
BMW				
F750GS	18' - 20'	VINTAGE	9779	(*)
F800 R	09' - 14'	R19	4185	(*)
F800 R	15' - 20'	R19	7707	(*)
F800 R	15' - 20'	PRO	7699	(*)
F800 S	06' - 11'	R19	4185	(*)

2021 MODELS: www.puig.tv

MODEL	YEAR	TYPE OF FRAME SLIDER	REFERENCE	N
F850GS	18' - 20'	VINTAGE	9779	(*)
F900 R	20'	R19	20293	(*)
F900 R	20'	PRO	20389	(*)
F900 XR	20'	R19	20388	(*)
F900 XR	20'	PRO	20389	(*)
G310 GS	17' - 20'	R19	8566	(*)
G310 R	16' - 20'	R19	8566	(*)
S1000 R	14' - 16'	R12	7061	(*)
S1000 R	17' - 20'	R19	9488	(*)
S1000 RR	09' - 11'	R12	5579	(*)
S1000 RR	09' - 11'	PRO	5282	(*)
S1000 RR	12' - 14'	R12	6060	(*)
S1000 RR	12' - 14'	PRO	6070	(*)
S1000 RR	15' - 18'	R12	5579	(*)
S1000 RR	15' - 18'	PRO	5282	(*)
S1000 RR	19' - 20'	R19	3706	(*)
S1000 RR	19' - 20'	PRO	3707	(*)
S1000 XR	15' - 19'	R19	7709	(*)
S1000 XR	20'	PRO	20458	(*)
S1000 XR	20'	R19	20457	(*)
DUCATI				
DIAVEL 1260/S	19' - 20'	R12	8567	(*)
HYPERMOTARD 821/SP	13' - 15'	R12	6557	(*)
HYPERMOTARD 939/SP	16' - 18'	R12	6557	(*)
HYPERSTRADA 939	16' - 17'	R12	6557	(*)
HYPERMOTARD 950/SP	19' - 20'	R12	9497	(*)
MONSTER 620	02' - 06'	R12	1850	(*)
MONSTER 695	06' - 07'	R12	1850	(*)
MONSTER 696	08' - 14'	R12	4705	(*)
MONSTER 796	10' - 14'	R12	4705	(*)
MONSTER 797	17' - 20'	R12	9497	(*)
MONSTER 800	03' - 04'	R12	1850	(*)
MONSTER 821	14' - 20'	R19	7062	(*)
MONSTER 1000	02' - 05'	R12	1850	(*)
MONSTER 1100/S	09' - 10'	R12	4705	(*)
MONSTER 1100 EVO	11' - 13'	R12	4705	(*)
MONSTER 1200/S	14' - 16'	R19	7062	(*)
MONSTER 1200/S	17' - 20'	R19	7062	(*)
MONSTER 1200 R	16' - 20'	R19	7062	(*)



N
Black

(-) Supplied with holesaw to drill bodywork.
(*) Check price with your distributor.

IMPORTANT: Indicate code color after part#. Example 0973A

FRAME SLIDERS

HI-TECH PARTS | TYPE OF FRAME SLIDERS:

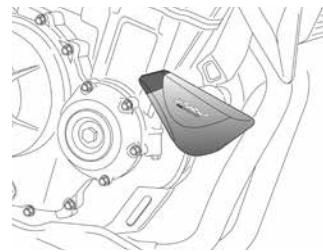

FRAME SLIDER PRO

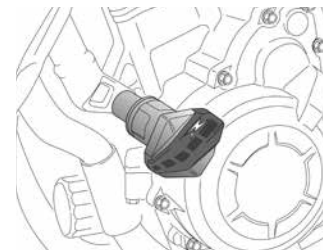

FRAME SLIDER R19



FRAME SLIDER VINTAGE

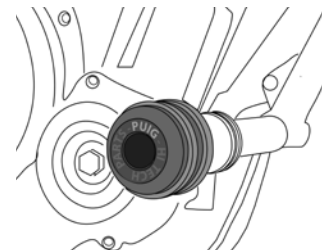

FRAME SLIDER VINTAGE 2.0.

2021 MODELS: www.puig.tv

MODEL	YEAR	TYPE OF FRAME SLIDER	REFERENCE	N
MULTISTRADA 950	19' - 20'	R19	3762	(*)
MULTISTRADA 1200/S	10' - 14'	PRO	5303	(*)
SCRAMBLER ICON	15' - 20'	VINTAGE	8150	(*)
SCRAMBLER CLASSIC	15' - 20'	VINTAGE	8150	(*)
SCRAMBLER URBAN ENDURO	15' - 16'	VINTAGE	8150	(*)
SCRAMBLER FULL THROTTLE	15' - 20'	VINTAGE	8150	(*)
SCRAMBLER SIXTY2	16' - 20'	VINTAGE	8150	(*)
SCRAMBLER FLAT TRACK PRO	16'	VINTAGE	8150	(*)
SCRAMBLER DESERT SLED	17' - 20'	VINTAGE	8150	(*)
SCRAMBLER CAFE RACER	17' - 20'	VINTAGE	8150	(*)
SCRAMBLER 1100	18' - 20'	VINTAGE	8150	(*)
SCRAMBLER 1100 SPORT	18' - 20'	VINTAGE	8150	(*)
SCRAMBLER 1100 SPECIAL	18' - 20'	VINTAGE	8150	(*)
STREETFIGHTER 848	12' - 15'	PRO	5303	(*)
STREETFIGHTER 1100	09' - 12'	PRO	5303	(*)
STREETFIGHTER 1100 S	09' - 13'	PRO	5303	(*)
STREETFIGHTER V4/S	20'	R19	20468	(*)
X DIAVEL/S	16' - 20'	R12	8567	(*)
HONDA				
CB125F	15' - 20'	R19	7931	(*)
CB125R NEO SPORTS CAFE	18' - 20'	R19	9654	(*)
CB300F	15' - 19'	R12	7932	(*)
CB300R NEO SPORTS CAFE	18' - 20'	R19	9757	(*)
CB500F	13' - 20'	PRO	6468	(*)
CB500F	13' - 20'	R19	6560	(*)
CB500X	13' - 20'	PRO	6468	(*)
CB500X	13' - 20'	R19	6560	(*)
CB600F HORNET	98' - 06'	R12	1851	(*)
CB600F HORNET	07' - 15'	R19	4423	(*)
CB650F	14' - 16'	R19	7057	(*)
CB650F	14' - 16'	PRO	7070	(*)
CB650F	17' - 20'	R19	9443	(*)

2021 MODELS: www.puig.tv

MODEL	YEAR	TYPE OF FRAME SLIDER	REFERENCE	N
CB650F	17' - 20'	PRO	7070	(*)
CB650R NEO SPORTS CAFÉ	19' - 20'	R19	9443	(*)
CB650R NEO SPORTS CAFÉ	19' - 20'	PRO	7070	(*)
CB1000R NEO SPORTS CAFE	18' - 20'	R12	9753	(*)
CB1000R NEO SPORTS CAFE	18' - 20'	PRO	9754	(*)
CBF600	04' - 07'	R19	1853	(*)
CBF600/S	08' - 14'	R19	4423	(*)
CBR500R	13' - 15'	R12	6559	(*)
CBR500R	16' - 18'	PRO	8575	(*)
CBR500R	16' - 18'	R19	8576	(*)
CBR500R	19' - 20'	R19	3598	(*)
CBR600F	99' - 07'	R12	1856	(*)
CBR600RR	03' - 06'	R19 (-)	1857	(*)
CBR600RR	07' - 08'	R12	4424	(*)
CBR650F	14' - 16'	R19	7056	(*)
CBR650F	17' - 19'	R19	7056	(*)
CBR650F	08' - 16'	PRO	5283	(*)
CBR650R	19' - 20'	R19	7056	(*)
CBR1000RR FIREBLADE	06' - 07'	R12	4062	(*)
CBR1000RR FIREBLADE/SP	20'	R19	20490	(*)
CBR1000RR FIREBLADE/SP	20'	PRO	20491	(*)
CROSSRUNNER	11' - 14'	R12	5695	(*)
NC700S/X	12' - 13'	PRO	6063	(*)
NC700S/X	12' - 13'	R19	6047	(*)
NC750S/X	14' - 20'	R19	6047	(*)
NC750S/X	14' - 20'	PRO	6063	(*)
VTR1000F FIRE STORM	97' - 07'	R12	3909	(*)
HYOSUNG				
GT650R	06'-12'	R12	6402	(*)
INDIAN				
FTR 1200	19' - 20'	VINTAGE 2.0.	20463	(*)
FTR 1200S	19' - 20'	VINTAGE 2.0.	20463	(*)
KAWASAKI				
ER-6N	05' - 08'	R19	4069	(*)
ER-6N	09' - 11'	R19	4964	(*)
ER-6N	12' - 16'	PRO	6067	(*)
ER-6N	12' - 16'	R19	6054	(*)
ER-6F	09' - 11'	R12	4965	(*)
ER-6F	12' - 16'	PRO	6068	(*)



N
Black

(-) Supplied with holesaw to drill bodywork.
(*) Check price with your distributor.

IMPORTANT: Indicate code color after part#. Example 0973A

FRAME SLIDERS

HI-TECH PARTS | TYPE OF FRAME SLIDERS:

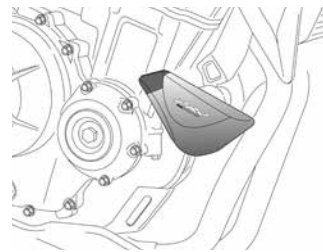

FRAME SLIDER PRO

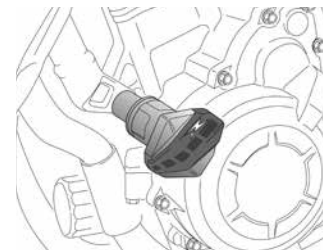

FRAME SLIDER R19



FRAME SLIDER VINTAGE

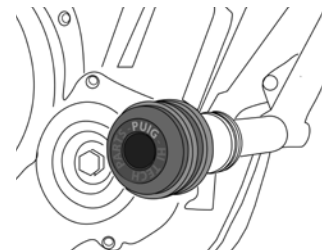

FRAME SLIDER VINTAGE 2.0.

2021 MODELS: www.puig.tv

MODEL	YEAR	TYPE OF FRAME SLIDER	REFERENCE	N
ER-6F	12' - 16'	R19	6055	(*)
KLV1000	04' - 05'	R12	1871	(*)
NINJA 125	19' - 20'	R12	3538	(*)
NINJA 250R	08' - 12'	R19	5170	(*)
NINJA 300	13' - 17'	R12	6562	(*)
NINJA 400	18' - 20'	R19	9628	(*)
NINJA 650	17' - 20'	R19	9466	(*)
NINJA 650	17' - 20'	PRO	9467	(*)
NINJA 1000SX	20'	R19	9399	(*)
NINJA 1000SX	20'	PRO	9400	(*)
NINJA H2 SX	18' - 20'	R12	9708	(*)
VERSYS 650	10' - 14'	PRO	5289	(*)
VERSYS 650	15' - 20'	PRO	7702	(*)
VERSYS 650	15' - 20'	R19	7714	(*)
VERSYS 1000	15' - 20'	PRO	7071	(*)
Z250SL	15' - 16'	R19	7716	(*)
Z300	15' - 17'	R12	7717	(*)
Z400	19' - 20'	R19	3546	(*)
Z650	17' - 20'	PRO	9354	(*)
Z650	17' - 20'	R19	9355	(*)
Z750	04' - 06'	R19	1860	(*)
Z750	07' - 12'	PRO	5290	(*)
Z750	07' - 12'	R19	4527	(*)
Z750S	05' - 06'	R19	1860	(*)
Z750R	11' - 12'	PRO	5290	(*)
Z750R	11' - 12'	R19	4527	(*)
Z800	13' - 16'	PRO	6471	(*)
Z800E	13' - 16'	PRO	6471	(*)
Z800	13' - 16'	R19	6563	(*)
Z800E	13' - 16'	R19	6563	(*)
Z900	17' - 20'	R19	9389	(*)
Z900	17' - 20'	PRO	9390	(*)

2021 MODELS: www.puig.tv

MODEL	YEAR	TYPE OF FRAME SLIDER	REFERENCE	N
Z900RS	18' - 20'	VINTAGE	9598	(*)
Z900RS CAFÉ	18' - 20'	VINTAGE	9598	(*)
Z1000	03' - 06'	R19	1860	(*)
Z1000	07' - 09'	R19	4527	(*)
Z1000	07' - 09'	PRO	5290	(*)
Z1000	14' - 20'	R19	7059	(*)
Z1000	14' - 20'	PRO	7071	(*)
Z1000R	17' - 20'	R19	7059	(*)
Z1000R	17' - 20'	PRO	7071	(*)
Z1000SX	11' - 13'	PRO	5689	(*)
Z1000SX	11' - 13'	R12	5701	(*)
Z1000SX	14' - 16'	R12	5701	(*)
Z1000SX	14' - 16'	PRO	5689	(*)
Z1000SX	17' - 20'	R12	9399	(*)
Z1000SX	17' - 20'	PRO	9400	(*)
ZX-6R	07' - 08'	R19	4429	(*)
ZX-6R	18' - 20'	PRO	3181	(*)
ZX-6R	18' - 20'	R19	3182	(*)
ZX-6R 636	13' - 16'	PRO	6472	(*)
ZX-6R 636	13' - 16'	R12	6564	(*)
ZX-10R	11' - 20'	R19	5702	(*)
ZX-10R	11' - 20'	PRO	5690	(*)
ZX-10RR	17' - 20'	R19	5702	(*)
ZX-10RR	17' - 20'	PRO	5690	(*)
ZX-10R SE	18' - 20'	R19	5702	(*)
ZX-10R SE	18' - 20'	PRO	5690	(*)
ZZR1400	12' - 20'	R19	6056	(*)
KTM				
125 DUKE	11' - 16'	R19	5700	(*)
125 DUKE	17' - 20'	R19	6565	(*)
200 DUKE	12' - 15'	R19	5700	(*)
390 DUKE	13' - 20'	R19	6565	(*)
790 DUKE	18' - 20'	R19	9674	(*)
1290 SUPERDUKE GT	16' - 19'	R19	7063	(*)
1290 SUPERDUKE R	14' - 19'	R19	7063	(*)
1290 SUPERDUKE R	20'	R19	20450	(*)
1290 SUPERDUKE R	20'	PRO	20451	(*)
MV AGUSTA				
BRUTALE 800/RR	17' - 20'	R12	9853	(*)



N
Black

(-) Supplied with holesaw to drill bodywork.
(*) Check price with your distributor.

IMPORTANT: Indicate code color after part#. Example 0973A

FRAME SLIDERS

HI-TECH PARTS | TYPE OF FRAME SLIDERS:

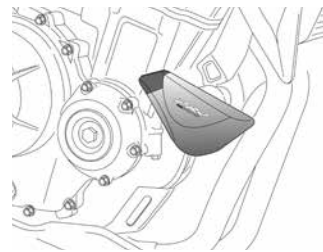

FRAME SLIDER PRO

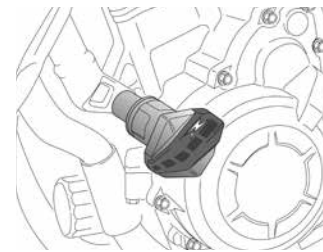

FRAME SLIDER R19



FRAME SLIDER VINTAGE

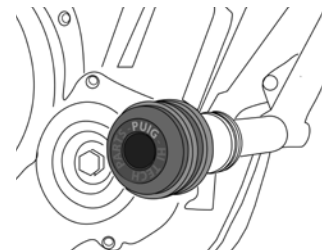

FRAME SLIDER VINTAGE 2.0.

2021 MODELS: www.puig.tv

MODEL	YEAR	TYPE OF FRAME SLIDER	REFERENCE	N
BRUTALE DRAGSTER 800/RR	17' - 20'	R12	9853	(*)
TURISMO VELOCE 800	17' - 20'	R12	9853	(*)
TURISMO VELOCE 800 LUSSO	17' - 20'	R12	9853	(*)
SUZUKI				
DL250 V-STROM	17' - 20'	R12	6243	(*)
DL650 V-STROM	04' - 20'	R19	1870	(*)
DL650XT V-STROM	15' - 20'	R19	1870	(*)
DL1000 V-STROM	02' - 07'	R12	1871	(*)
GS500	01' - 07'	R19	2017	(*)
GSF600 BANDIT	96' - 04'	R19	1869	(*)
GSF600S BANDIT	96' - 04'	R19	1869	(*)
GSF650 BANDIT	05' - 06'	R19	3918	(*)
GSF650 BANDIT	07' - 11'	R19	4428	(*)
GSF650S BANDIT	05' - 06'	R19	3918	(*)
GSF650S BANDIT	07' - 14'	R19	4428	(*)
GSF1200 BANDIT	96' - 05'	R19	1869	(*)
GSF1200S BANDIT	96' - 05'	R19	1869	(*)
GSF1250 BANDIT	07' - 13'	R19	4428	(*)
GSF1250S BANDIT	07' - 13'	R19	4428	(*)
GSR600	06' - 11'	R19	4067	(*)
GSR750	11' - 16'	PRO	5687	(*)
GSR750	11' - 16'	R19	5698	(*)
GSX650F	08' - 16'	R19	4654	(*)
GSX-R600	01' - 03'	R19	1971	(*)
GSX-R600	04' - 05'	R19	1865	(*)
GSX-R600	06' - 07'	R19	4066	(*)
GSX-R600	08' - 10'	R19	4652	(*)
GSX-R600	11' - 16'	PRO	5686	(*)
GSX-R750	00' - 03'	R19	1971	(*)
GSX-R750	04' - 05'	R19	1865	(*)
GSX-R750	06' - 07'	R12	4066	(*)
GSX-R750	08' - 10'	R19	4652	(*)

2021 MODELS: www.puig.tv

MODEL	YEAR	TYPE OF FRAME SLIDER	REFERENCE	N
GSX-R750	11' - 16'	PRO	5686	(*)
GSX-S750	17' - 20'	R19	5698	(*)
GSX-S750	17' - 20'	PRO	5687	(*)
GSX-R1000	07' - 08'	R19	4426	(*)
GSX-R1000	09' - 16'	PRO	5295	(*)
GSX-R1000/R	17' - 20'	R19	9000	(*)
GSX-R1000/R	17' - 20'	PRO	9370	(*)
GSX-S125	17' - 19'	R19	9960	(*)
GSX-S125	20'	R19	20353	(*)
GSX-S1000	15' - 20'	R19	7721	(*)
GSX-S1000	15' - 20'	PRO	7704	(*)
GSX-S1000F	15' - 20'	PRO	7705	(*)
INAZUMA	13' - 17'	R12	6243	(*)
KATANA	19' - 20'	R19	7721	(*)
KATANA	19' - 20'	PRO	7704	(*)
SFV650 GLADIUS	09' - 15'	R19	4962	(*)
SV650	03' - 06'	R19	1867	(*)
SV650S	03' - 08'	R19	1867	(*)
SV650	16' - 20'	R19	4962	(*)
SV650X	18' - 20'	R19	4962	(*)
TRIUMPH				
BONNEVILLE T100	16' - 19'	VINTAGE	8588	(*)
BONNEVILLE T120	16' - 19'	VINTAGE	8588	(*)
BONNEVILLE BOBBER	17' - 20'	VINTAGE	8588	(*)
DAYTONA 675	06' - 12'	R19	4631	(*)
SCRAMBLER 1200XC	19' - 20'	VINTAGE	3627	(*)
SPEED TWIN	19' - 20'	VINTAGE	3582	(*)
STREET TRIPLE	07' - 12'	R19	4631	(*)
STREET TRIPLE R	09' - 12'	R19	4631	(*)
STREET TRIPLE R/S	20'	R19	6571	(*)
STREET CUP	17' - 20'	VINTAGE	8588	(*)
STREET SCRAMBLER	17' - 20'	VINTAGE	3627	(*)
STREET TWIN	16' - 20'	VINTAGE	8588	(*)
THRUXTON 1200/R	16' - 20'	VINTAGE	8588	(*)
YAMAHA				
FAZER8	13' - 16'	R19	5584	(*)
FJR1300A/AS	06' - 12'	R19	4086	(*)
FJR1300A/AS	13' - 17'	R19	6572	(*)
FZ1	06' - 15'	R19	5584	(*)



N
Black

(-) Supplied with holesaw to drill bodywork.
(*) Check price with your distributor.

IMPORTANT: Indicate code color after part#. Example 0973A

FRAME SLIDERS

HI-TECH PARTS | TYPE OF FRAME SLIDERS:

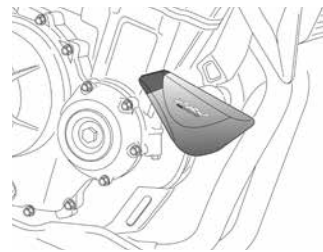

FRAME SLIDER PRO

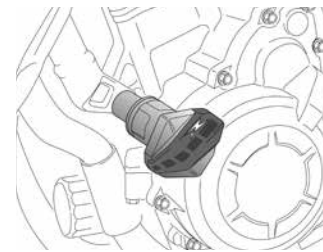

FRAME SLIDER R19



FRAME SLIDER VINTAGE

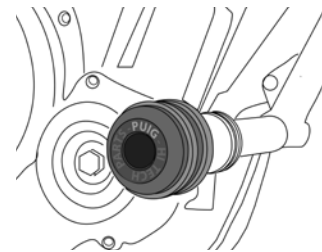

FRAME SLIDER VINTAGE 2.0.

2021 MODELS: www.puig.tv

MODEL	YEAR	TYPE OF FRAME SLIDER	REFERENCE	N
FZ1 FAZER	06' - 15'	R19	5584	(*)
FZ6	04' - 08'	R19	1873	(*)
FZ6 FAZER	04' - 08'	R19	1873	(*)
FZ6 FAZER S2	07' - 10'	R19	1873	(*)
FZ8	10' - 16'	R19	5584	(*)
FZ8 FAZER	10' - 12'	R19	5584	(*)
MT-125	15' - 19'	R19	7723	(*)
MT-125	20'	R19	3885	(*)
MT-03	16' - 20'	R19	8589	(*)
MT-03	16' - 20'	PRO	8590	(*)
MT-07	14' - 20'	R19	7064	(*)
MT-07	14' - 20'	PRO	7074	(*)
MT-07 TRACER	16' - 19'	R19	7064	(*)
MT-07 TRACER	20'	R19	7064	(*)
MT-07 TRACER	16' - 19'	PRO	7074	(*)
MT-07 TRACER GT	19'	R19	7064	(*)
MT-07 TRACER GT	19'	PRO	7074	(*)
MT-09	13' - 16'	R19	6857	(*)
MT-09	13' - 16'	PRO	7316	(*)
MT-09	17' - 20'	R19	9380	(*)
MT-09	17' - 20'	PRO	7316	(*)
MT-09 SP	18' - 20'	R19	9380	(*)
MT-09 SP	18' - 20'	PRO	7316	(*)
MT-09 TRACER	15' - 20'	R19	6857	(*)
MT-09 TRACER	15' - 20'	PRO	7316	(*)
MT-09 TRACER GT	18' - 20'	R19	6857	(*)
MT-09 TRACER GT	18' - 20'	PRO	7316	(*)
MT-10	16' - 20'	R19	7724	(*)
MT-10	16' - 20'	PRO	8592	(*)
MT-10 SP	17' - 20'	R19	7724	(*)
MT-10 SP	17' - 20'	PRO	8592	(*)
XJ6	09' - 16'	R19	4948	(*)

2021 MODELS: www.puig.tv

MODEL	YEAR	TYPE OF FRAME SLIDER	REFERENCE	N
XJ6 DIVERSION	09' - 16'	R19	4948	(*)
XSR 700	16' - 20'	PRO	7074	(*)
XSR 700	16' - 20'	VINTAGE	8593	(*)
XSR 700 XTRIBUTE	19' - 20'	PRO	7074	(*)
XSR 700 XTRIBUTE	19' - 20'	VINTAGE	8593	(*)
XSR 900	16' - 20'	PRO	7316	(*)
XSR 900	16' - 20'	VINTAGE	8594	(*)
YZF-R1	02' - 03'	R12	1876	(*)
YZF-R1	04' - 06'	R19	1878	(*)
YZF-R1 SP	06'	R19	1878	(*)
YZF-R1	07' - 08'	R19	4425	(*)
YZF-R1	15' - 20'	R19	7724	(*)
YZF-R1	15' - 20'	PRO	7706	(*)
YZF-R1M	17' - 20'	R19	7724	(*)
YZF-R1M	17' - 20'	PRO	7706	(*)
YZF-R3	15' - 18'	R19	7725	(*)
YZF-R6	03' - 05'	R12	1877	(*)
YZF-R6	06' - 07'	R19	4064	(*)
YZF-R6	08' - 16'	R19	4650	(*)
YZF-R6	17' - 20'	R12 (-)	9866	(*)



N
Black

(-) Supplied with holesaw to drill bodywork.

(*) Check price with your distributor.

IMPORTANT: Indicate code color after part#. Example 0973A

ENGINE GUARDS

HI-TECH PARTS | TECHNICAL SECTION

2021 MODELS: www.puig.tv

MODEL	YEAR	Ø	REF.	N	U
BMW					
F650 GS	08' - 12'	25 mm.	5983	(*)	
F700 GS	12' - 17'	25 mm.	5983	(*)	
F750GS	18' - 20'	25 mm.	9780	(*)	
F800 GS	08' - 12'	25 mm.	5983	(*)	
F800 GS	13' - 17'	25 mm.	6537	(*)	
F850GS	18' - 20'	25 mm.	9780	(*)	
R1200GS - LOW	13'	25 mm.	6538	(*)	(*)
R1200GS - HIGH	14' - 16'	25 mm.	7542	(*)	(*)
R1200GS - LOW	14' - 16'	25 mm.	7543	(*)	(*)
R1200GS - HIGH	17' - 18'	25 mm.	9461	(*)	(*)
R1200GS - LOW	17' - 18'	25 mm.	7543	(*)	(*)
R1200GS RALLYE/EXCLUSIVE-HIGH	17' - 18'	25 mm.	9461	(*)	(*)
R1200GS RALLYE/EXCLUSIVE-LOW	17' - 18'	25 mm.	7543	(*)	(*)
R1200R	15' - 18'	25 mm.	7768	(*)	
R1200RS	15' - 18'	25 mm.	7768	(*)	
R1250GS - HIGH	18' - 20'	25 mm.	9461	(*)	(*)
R1250GS - LOW	18' - 20'	25 mm.	2249	(*)	(*)
R1250GS HP - HIGH	18' - 20'	25 mm.	9461	(*)	(*)
R1250GS HP - LOW	18' - 20'	25 mm.	2249	(*)	(*)
R NINE T	14' - 20'	25 mm.	7095	(*)	
R NINE T SCRAMBLER	16' - 20'	25 mm.	7095	(*)	
R NINE T RACER	17' - 20'	25 mm.	7095	(*)	
R NINE T PURE	17' - 20'	25 mm.	7095	(*)	
R NINE T URBAN G/S	17' - 20'	25 mm.	7095	(*)	
HONDA					
CB500F/X	13' - 18'	25 mm.	6539	(*)	
CB500F	19' - 20'	25 mm.	6539	(*)	
CB500X	19' - 20'	25 mm.	3572	(*)	
CRF1100L AFRICA TWIN	20'	25 mm.	3866	(*)	
CMX 500 REBEL	17' - 20'	25 mm.	3742	(*)	
NC700S/X	12' - 13'	25 mm.	6387(#)	(*)	
NC750S/X	14' - 20'	25 mm.	6387(#)	(*)	

N
BlackU
Grey2021 MODELS: www.puig.tv

MODEL	YEAR	Ø	REF.	N	U
KAWASAKI					
VERSYS 650	15' - 20'	25 mm.	7773	(*)	
VULCAN S	15' - 20'	25 mm.	8544	(*)	
VULCAN S CAFE	17' - 20'	32 mm.	8544	(*)	
SUZUKI					
DL650 V-STROM	12' - 20'	25 mm.	5884	(*)	
DL650XT V-STROM	15' - 20'	25 mm.	5884	(*)	
DL1050 V-STROM	20'	25 mm.	20404	(*)	
DL1050XT V-STROM	20'	25 mm.	20404	(*)	
TRIUMPH					
TIGER 900	20'	25 mm.	20384	(*)	
TIGER 900 GT	20'	25 mm.	20384	(*)	
TIGER 900 GT LOW	20'	25 mm.	20384	(*)	
TIGER 900 GT PRO	20'	25 mm.	20384	(*)	
TIGER 900 RALLY	20'	25 mm.	20384	(*)	
TIGER 900 RALLY PRO	20'	25 mm.	20384	(*)	
YAMAHA					
MT-07 TRACER	20'	25 mm.	20443	(*)	
MT-09 TRACER	15' - 17'	25 mm.	7777	(*)	
MT-09 TRACER	18' - 20'	25 mm.	9720	(*)	
MT-09 TRACER GT	18' - 20'	25 mm.	9720	(*)	
TENERE 700	19' - 20'	25 mm.	3814	(*)	

NOTE: PREVIOUSLY VERIFY ANY INTERFERENCE BETWEEN OUR PRODUCT AND ANY OTHER ACCESSORY (DEM OR AFTERMARKET) ALREADY INSTALLED ON THE MOTORCYCLE.

(#) Compatible con los modelos DCT.

(*) Check price with your distributor.

IMPORTANT: Indicate code color after part#. Example 0973A

ENGINE PROTECTIVE COVERS

HI-TECH PARTS | TECHNICAL SECTION



REF. 20134N

MATERIAL

Manufactured in 4mm thick polypropylene for strength, durability and good appearance. The covers are simply bolt-on on the oem engine case.

Compact for a maximum distance to the ground, matt finished, and protecting one of the most vulnerable areas of the machine.

2021 MODELS: www.puig.tv				
MODEL	YEAR	REF.	PIECES	N
BMW				
S1000R	09' - 16'	20168	3	(*)
S1000R	17' - 20'	20137	3	(*)
S1000RR	09' - 14'	20168	3	(*)
S1000RR	15' - 18'	20137	3	(*)
S1000RR	19' - 20'	20215	3	(*)
S1000XR	15' - 20'	20137	3	(*)
DUCATI				
1199 PANGALE	12' - 15'	20138	2	(*)
1299 PANIGALE	15' - 17'	20138	2	(*)
PANIGALE 1100 V4	18' - 20'	20139	2	(*)
PANIGALE 1100 V4R	19' - 20'	20139	2	(*)
PANIGALE 1100 V4S	18' - 20'	20139	2	(*)



N
Black

2021 MODELS: www.puig.tv

MODEL	YEAR	REF.	PIECES	N
HONDA				
CBR600RR	07' - 16'	20121	3	(*)
CBR1000RR FIREBLADE	08' - 16'	20122	3	(*)
CBR1000RR FIREBLADE/SP/SP2	17' - 19'	20289	3	(*)
KAWASAKI				
ER-6N	06' - 16'	20134	3	(*)
NINJA 250SL	15' - 16'	20131	2	(*)
NINJA 250R	08' - 12'	20131	2	(*)
NINJA 300	14' - 17'	20131	2	(*)
NINJA 400	18' - 20'	20169	3	(*)
Z250	14' - 16'	20131	2	(*)
Z300	15' - 17'	20131	2	(*)
Z800	13' - 16'	20136	3	(*)
Z800E	13' - 16'	20136	3	(*)
Z900	17' - 20'	20135	3	(*)
Z1000	14' - 19'	20417	3	(*)
ZX-6R	09' - 16'	20132	3	(*)
ZX-6R	18' - 20'	20132	3	(*)
ZX-6R 636	13' - 17'	20132	3	(*)
ZX-10R	11' - 20'	20133	3	(*)
ZX-10RR	17' - 20'	20133	3	(*)
KTM				
390 DUKE	14' - 15'	20140	2	(*)
390 DUKE	16' - 19'	20141	2	(*)
790 DUKE	18' - 20'	20221	3	(*)
RC390	17' - 19'	20141	2	(*)
RC390	16' - 17'	20140	2	(*)
SUZUKI				
GSX-R600/750	11' - 16'	20124	3	(*)
GSX-R1000	09' - 16'	20125	3	(*)
GSX-R1000/R	17' - 20'	20126	3	(*)
YAMAHA				
NIKEN	18' - 20'	20128	3	(*)
MT-09	14' - 20'	20128	3	(*)
MT-09 SP	18' - 20'	20128	3	(*)
MT-09 TRACER	15' - 20'	20128	3	(*)
MT-09 TRACER GT	18' - 20'	20128	3	(*)
MT-10	16' - 20'	20142	3	(*)
YZF-R1	15' - 20'	20127	3	(*)
YZF-R1M	17' - 20'	20127	3	(*)
YZF-R3	16' - 20'	20130	3	(*)
YZF-R6	06' - 20'	20129	3	(*)

(*) Check price with your distributor.

IMPORTANT: Indicate code color after part#. Example 0973A

ALUMINIUM FILTER COVER / CLUTCH COVER / SPROCKET COVER

HI-TECH PARTS | TECHNICAL SECTION

REF. 9993N



// ALUMINIUM FILTER COVER

MODEL	YEAR	REF.	N
HARLEY DAVIDSON			
SPORTSTER 883 IRON	16' - 20'	9993	(*)

N
Black

REF. 9855N



// CLUTCH COVER

MODEL	YEAR	REF.	A N O R P
YAMAHA			
T-MAX 530	12' - 16'	8501	(*)
T-MAX 530/DX/SX	17' - 19'	9855	(*)
T-MAX 560 /SX/DX/MAX TECH	20'	9855	(*)

A
BlueN
BlackO
GoldR
RedP
Silver

REF. 8502O



// SPROCKET COVER

MODEL	YEAR	REF.	A N O R P
KYMCO			
AK550	17' - 20'	9547	(*)
YAMAHA			
T-MAX 530	12' - 16'	8502	(*)
T-MAX/DX/SX	17' - 19'	8502	(*)
T-MAX 560 /SX/DX/MAX TECH	20'	8502	(*)

A
BlueN
BlackO
GoldR
RedP
Silver

IMPORTANT: Indicate code color after part#. Example: 0973A.

SIDE PANELS

HI-TECH PARTS | TECHNICAL SECTION



1

MATERIAL: Aluminium
REF. 9590P



2

MATERIAL: ABS
REF. 8562J



REF. 6805J

// RETRO SIDE COVERS

2021 MODELS: www.puig.tv

MODEL	YEAR	REF.	J	C	P
BMW					
R NINE T (1)	14' - 20'	9590			(*)
R NINE T SCRAMBLER (1)	16' - 20'	9590			(*)
R NINE T PURE (1)	17' - 20'	9590			(*)
R NINE T RACER (1)	17' - 20'	9590			(*)
R NINE T URBAN G/S (1)	17' - 20'	9590			(*)
YAMAHA					
XSR700 (2)	16' - 20'	8562 (#)		(*)	
XSR700 XTRIBUTE (2)	19' - 20'	8562 (#)		(*)	
XSR900 (2)	16' - 19'	8563 (#)		(*)	
UNIVERSAL					
PLASTICS UNIVERSAL SIDE COVERS WITHOUT FITTINGS		9232	(*)	(*)	
UNIVERSAL ALUMINIUM SIDE COVERS WITHOUT FITTINGS		9599			(*)



CLEAN

Protect the rider and motorcycle from dirt on all type of roads.



DESIGN

Covers empty areas of the motorcycles.

U
GreyC
Carbon lookJ
Matt blackP
AluminiumN
Black

// SIDE PANELS

2021 MODELS: www.puig.tv

MODEL	YEAR	REF.	J	C	U	N
BMW						
F750 GS	18' - 20'	9791	(*)			
F850 GS	18' - 20'	9791	(*)			
F850 GS ADVENTURE	19' - 20'	3596	(*)			
R1200 GS	13' - 18'	6805	(*)		(*)	
R1200 GS ADVENTURE	14' - 18'	7518	(*)		(*)	
R1200GS EXCLUSIVE	17' - 18'	6805	(*)		(*)	
R1200GS RALLYE	17' - 18'	6805	(*)		(*)	
R1200 RT	05' - 13'	6367	(*)		(*)	
R1250GS	18' - 20'	6805	(*)		(*)	
R1250GS ADVENTURE	18' - 20'	7518	(*)		(*)	
R1250GS HP	18' - 20'	6805	(*)		(*)	
S1000RR	19' - 20'	3833				(*)
HONDA						
CRF1100L AFRICA TWIN	20'	3822	(*)			
CRF1100L AFRICA TWIN ADVENTURE SPORTS	20'	3822	(*)			
KTM						
1050 ADVENTURE	15' - 16'	7513	(*)			
1090 ADVENTURE/R	17' - 20'	7513	(*)			
1190 ADVENTURE/R	13' - 16'	7513	(*)			
1290 SUPER ADVENTURE	15' - 16'	7513	(*)			
1290 SUPER ADVENTURE R/S	17' - 20'	7513	(*)			
1290 SUPER ADVENTURE T	17'	7513	(*)			
YAMAHA						
XT1200Z SUPER TÉNÉRÉ	10' - 20'	6804	(*)			
SPARES						
MT-09 SIDE COVERS		9233	(*)	(*)		
R1200GS SIDE COVERS		9234	(*)			

(#) ADHESIVE KIT INCLUDED.

(*) Check price with your distributor.

IMPORTANT: Indicate code color after part#. Example: 0973A.



REAR DEFLECTORS

HI-TECH PARTS | TECHNICAL SECTION

MODEL	YEAR	REF.	J	C	U
BMW					
R1200 GS	04' - 12'	6802	(*)	(*)	(*)
R1200 GS	13' - 18'	6869	(*)	(*)	(*)
R1200 GS ADVENTURE	06' - 13'	6802	(*)	(*)	(*)
R1200 GS ADVENTURE	14' - 18'	6869	(*)	(*)	(*)
R1200GS EXCLUSIVE	17' - 18'	6869	(*)	(*)	(*)
R1200GS RALLYE	17' - 18'	6869	(*)	(*)	(*)
R1200 RT	14' - 17'	7529	(*)		
R1250GS	18' - 20'	6869	(*)	(*)	(*)
R1250 GS ADVENTURE	18' - 20'	6869	(*)	(*)	(*)
R1250 GS HP	18' - 20'	6869	(*)	(*)	(*)
R1250 RT	19' - 20'	7529	(*)		



C Carbon look
J Matt black
U Grey



REF. 6869J

(*) Check price with your distributor.
IMPORTANT: Indicate code color after part#. Example 0973A



REAR BRAKE TANK COVER

HI-TECH PARTS | TECHNICAL SECTION

MODEL	YEAR	REF.	J	C
YAMAHA				
MT-07	14' - 20'	7578	(*)	(*)
MT-09	13' - 20'	7578	(*)	(*)
MT-09 SP	18' - 20'	7578	(*)	(*)
MT-07 TRACER	16' - 20'	7578	(*)	(*)
MT-07 TRACER GT	19'	7578	(*)	(*)
MT-09 TRACER	15' - 20'	8542	(*)	(*)
MT-09 TRACER GT	18' - 20'	8542	(*)	(*)



REF. 7578J



C Carbon look
J Matt black

(*) Check price with your distributor.
IMPORTANT: Indicate code color after part#. Example 0973A



INTAKE COVER

HI-TECH PARTS | TECHNICAL SECTION

MODEL	YEAR	REF.	N
BMW			
R1200 GS	13' - 18'	9175	(*)
R1200GS EXCLUSIVE	17' - 18'	9175	(*)
R1200GS RALLYE	17' - 18'	9175	(*)
R1250GS	18' - 19'	9175	(*)
R1250 GS HP	18' - 19'	9175	(*)
R1250 GS ADVENTURE	18' - 19'	9175	(*)



REF. 9175N



N
Black

(*) Check price with your distributor.
IMPORTANT: Indicate code color after part#. Example 0973A



REAR LUGGAGE SUPPORT COVERS

HI-TECH PARTS | TECHNICAL SECTION

MODEL	YEAR	REF.	J	C
YAMAHA				
MT-09 TRACER	15' - 17'	8089	(*)	(*)



REF. 8089J

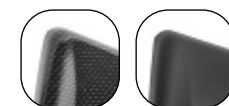

C
Carbon look

J
Matt black

(*) Check price with your distributor.
IMPORTANT: Indicate code color after part#. Example 0973A



REAR HANDLES COVERS

HI-TECH PARTS | TECHNICAL SECTION

MODEL	YEAR	REF.	J
BMW			
R1200 R	15' - 18'	9083	(*)
R1200 RS	15' - 18'	9083	(*)
R1250 R	19' - 20'	9083	(*)
R1250 RS	19' - 20'	9083	(*)



REF. 9083J



J
Matt black

(*) Check price with your distributor.
IMPORTANT: Indicate code color after part#. Example 0973A

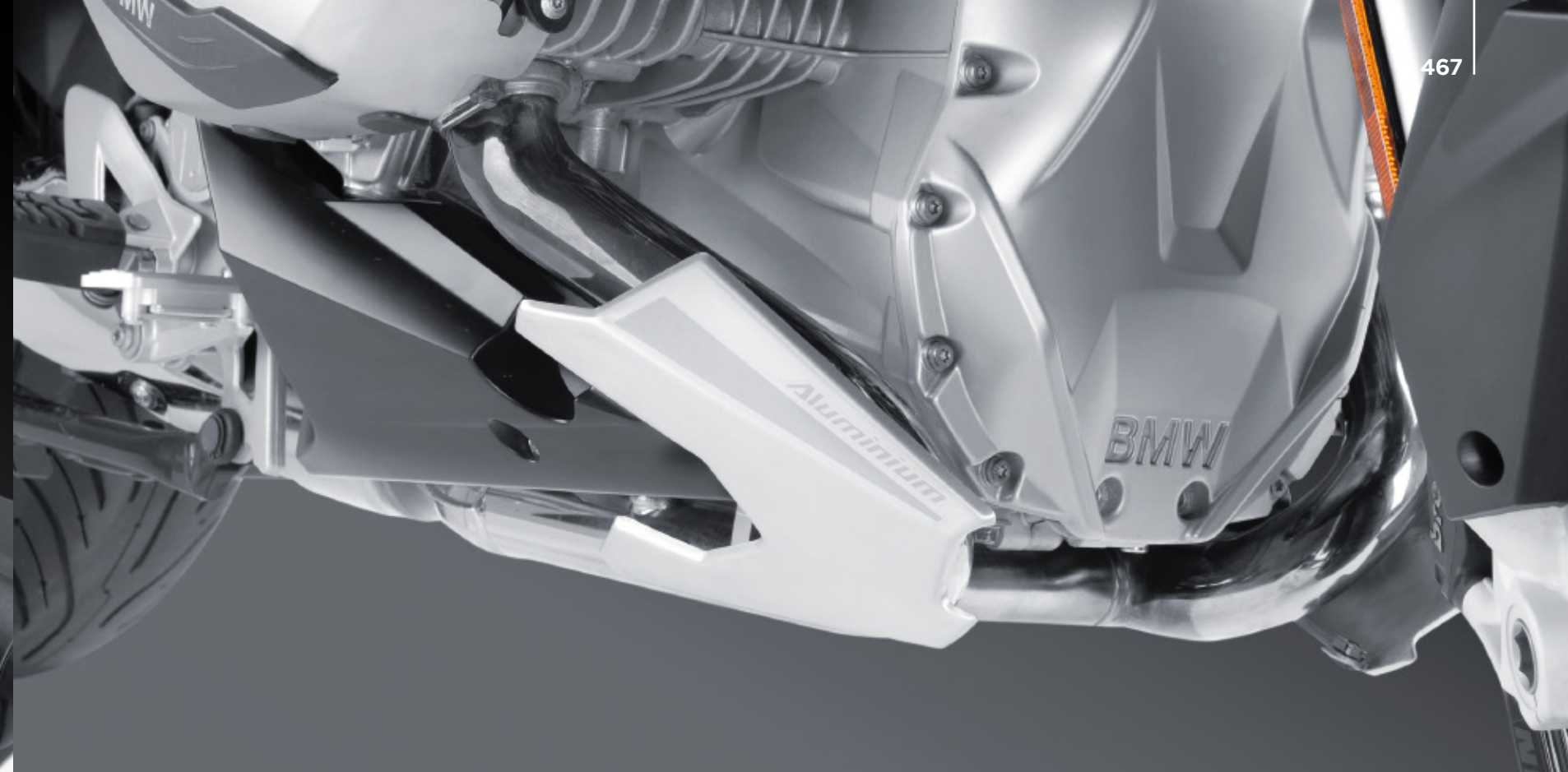

EXHAUST PROTECTOR - DEFLECTOR

HI-TECH PARTS | TECHNICAL SECTION

MODEL	YEAR	REF.	P
BMW			
R1200 RT	14' - 18'	8546	(*)



REF. 8546P

ALUMINIUM
BASE

FRONT DEFLECTOR

MODEL	YEAR	REF.	J
YAMAHA			
MT-09 TRACER	15' - 17'	8090	(*)



P
Aluminium



J
Matt black

(*) Check price with your distributor.
IMPORTANT: Indicate code color after part#. Example 0973A



REF. 8090J

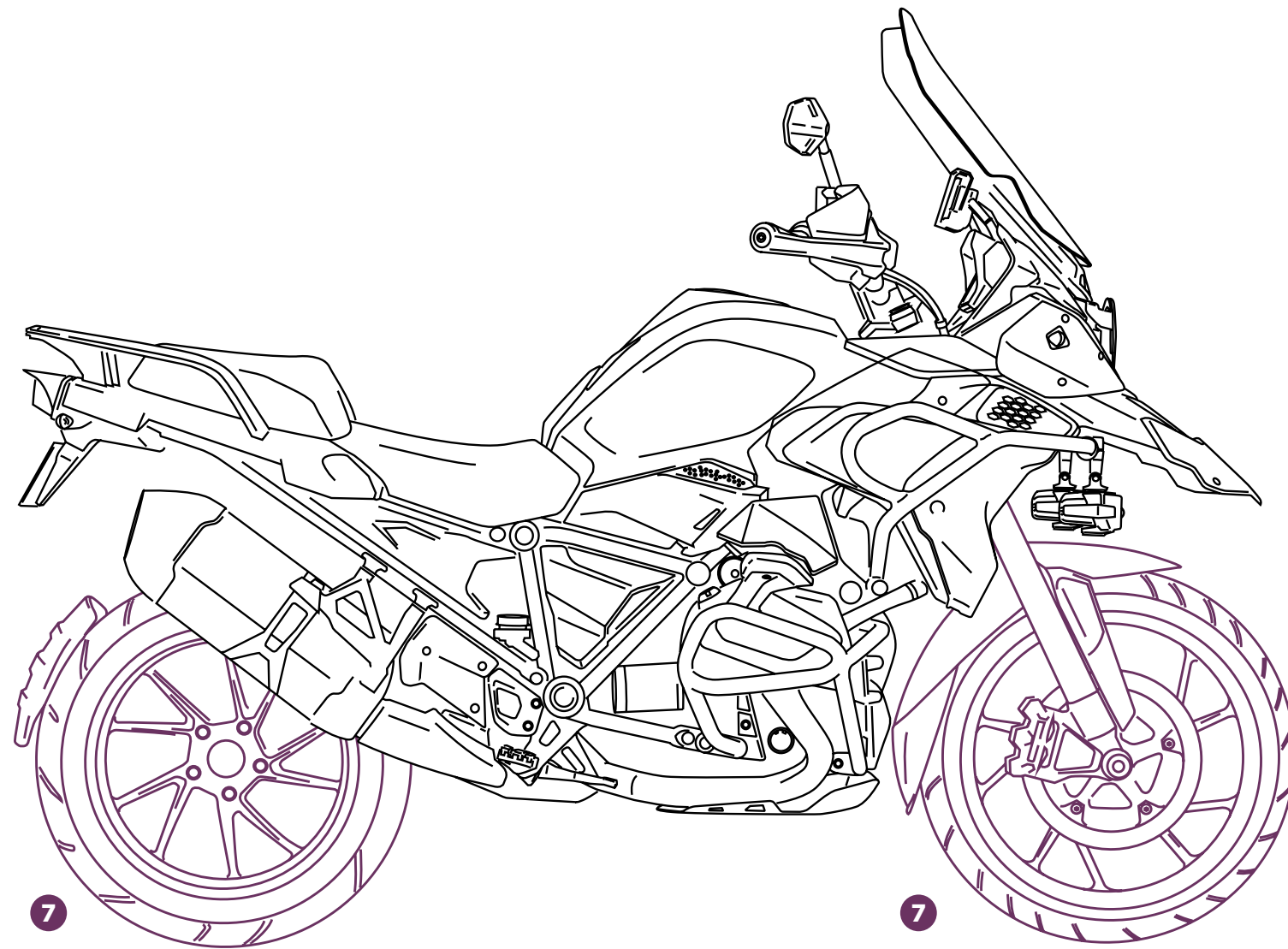

WHEELS AREA

ADHESIVE KIT FOR BMW CASES	511
ADHESIVE STRIPS	501
ADHESIVE STRIPS PREMIUM	503
ALUMINIUM FRONT FENDER	487
AXLE SLIDERS PHB19	497
FENDER EXTENSIONS	485
FRONT FENDER EXTENSION	489
REAR FENDER EXTENSION	479
REAR FENDERS	471
RIM STRIPS GS	508
SINGLE-SIDED REAR FENDER	483
SPECIAL RIM STRIPS	505
STAND SUPPORTS	516
SWING ARM PROTECTOR GS	509
TENSORS FOR REAR WHEEL BY PAIR	499
VALVES	498

REAR FENDERS

HI-TECH PARTS | TECHNICAL SECTION



Specific vanguard design for each bike, combined with the maximum protection against inclement weather.

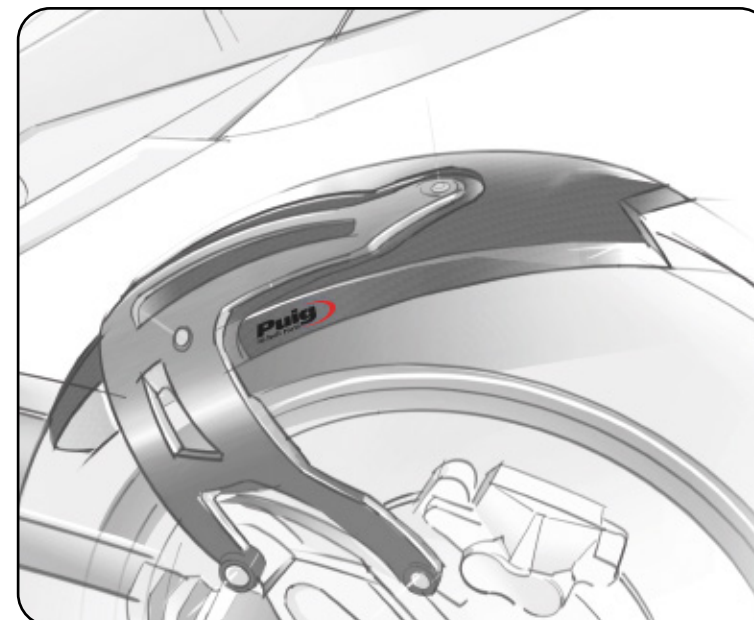

BMW R1200R 15'-18' (REF. 7682)

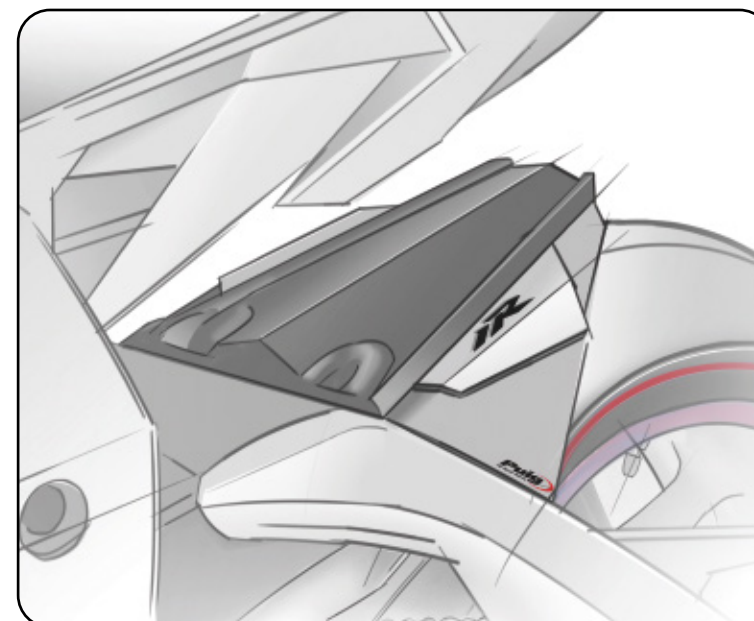

YAMAHA YZF-R1 15'-19' (REF. 7688)

// FENDER S

Maximum protection with a specific vanguard design.



// FENDER WITH ALUMINIUM SUPPORT

Support made of injected aluminium.



// FENDER R

Racing look with stainless steel detail.



REAR FENDERS

HI-TECH PARTS | TYPE OF FENDER:

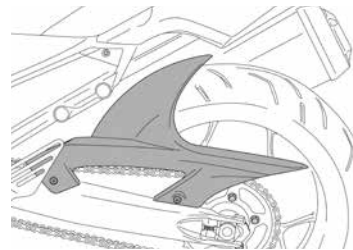

FENDER S



FENDER R

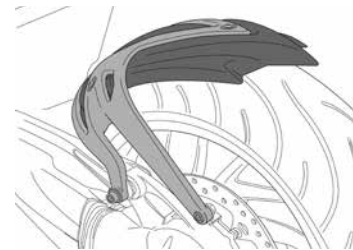

FENDER S WITH ALUMINIUM
SUPPORT

2021 MODELS: www.puig.tv

MODEL	YEAR	TYPE OF FENDER	REFERENCE	J	C
APRILIA					
SHIVER 750	07' - 16'	FENDER S	4902	(*)	(*)
SHIVER 750 GT	08' - 16'	FENDER S	4902	(*)	(*)
SHIVER 900	17' - 20'	FENDER S	4902	(*)	(*)
BMW					
F650 GS	99' - 07'	FENDER S	5925		(*)
F650 GS	08' - 12'	FENDER S	5865	(*)	(*)
F750GS	18' - 20'	FENDER S	9761	(*)	(*)
F800 GS	08' - 17'	FENDER S	5865	(*)	(*)
F800 GS ADVENTURE	13' - 17'	FENDER S	5865	(*)	(*)
F800 GT	13' - 20'	FENDER S	6447	(*)	(*)
F800 R	09' - 20'	FENDER S	5882	(*)	(*)
F850GS	18' - 20'	FENDER S	9761	(*)	(*)
F850GS ADVENTURE	19' - 20'	FENDER S	9761	(*)	(*)
F900R	20'	FENDER S	20419	(*)	(*)
F900XR	20'	FENDER S	20419	(*)	(*)
G310 GS	17' - 20'	FENDER S	9949	(*)	(*)
G650 GS	11' - 16'	FENDER S	5925		(*)
K1200 R	05' - 08'	FENDER WITH ALUMINIUM SUPPORT (NC) (#)	5887	(*)	(*)
K1200 R SPORT	07' - 08'	FENDER WITH ALUMINIUM SUPPORT (NC) (#)	5887	(*)	(*)
K1200 S	04' - 08'	FENDER WITH ALUMINIUM SUPPORT (NC) (#)	5887	(*)	(*)
K1300 R	09' - 16'	FENDER WITH ALUMINIUM SUPPORT (NC) (#)	5887	(*)	(*)
K1300 S	09' - 16'	FENDER WITH ALUMINIUM SUPPORT (NC) (#)	5887	(*)	(*)
R1100 GS	94' - 99'	FENDER WITH ALUMINIUM SUPPORT (NC) (#)	5886	(*)	(*)
R1150 GS	99' - 04'	FENDER WITH ALUMINIUM SUPPORT (NC) (#)	5886	(*)	(*)
R1150 GS ADVENTURE	02' - 05'	FENDER WITH ALUMINIUM SUPPORT (NC) (#)	5886	(*)	(*)
R1200 GS	04' - 12'	FENDER WITH ALUMINIUM SUPPORT (#)	5055	(*)	(*)
R1200 GS	13' - 17'	FENDER WITH ALUMINIUM SUPPORT (#)	6352	(*)	(*)
R1200 GS	18'	FENDER WITH ALUMINIUM SUPPORT (#)	1947	(*)	(*)
R1200GS EXCLUSIVE	17'	FENDER WITH ALUMINIUM SUPPORT (#)	6352	(*)	(*)

2021 MODELS: www.puig.tv

MODEL	YEAR	TYPE OF FENDER	REFERENCE	J	C
R1200GS RALLYE	17'	FENDER WITH ALUMINIUM SUPPORT (#)	6352	(*)	(*)
R1200GS EXCLUSIVE	18'	FENDER WITH ALUMINIUM SUPPORT (#)	1947	(*)	(*)
R1200GS RALLYE	18'	FENDER WITH ALUMINIUM SUPPORT (#)	1947	(*)	(*)
R1200 GS ADVENTURE	06' - 13'	FENDER WITH ALUMINIUM SUPPORT (#)	5055	(*)	(*)
R1200GS ADVENTURE	14' - 17'	FENDER WITH ALUMINIUM SUPPORT (#)	6352	(*)	(*)
R1200GS ADVENTURE	18'	FENDER WITH ALUMINIUM SUPPORT (#)	1947	(*)	(*)
R1200 R	06' - 14'	FENDER WITH ALUMINIUM SUPPORT (#)	5861	(*)	(*)
R1200 R	15' - 17'	FENDER WITH ALUMINIUM SUPPORT (#)	7682	(*)	(*)
R1200 RS	15' - 17'	FENDER WITH ALUMINIUM SUPPORT (#)	7682	(*)	(*)
R1200 RS	18'	FENDER WITH ALUMINIUM SUPPORT (#)	3503	(*)	(*)
R1200 S	06' - 08'	FENDER WITH ALUMINIUM SUPPORT (#)	5861	(*)	(*)
R1250GS	18' - 20'	FENDER WITH ALUMINIUM SUPPORT (#)	1947	(*)	(*)
R1250GS HP	18' - 20'	FENDER WITH ALUMINIUM SUPPORT (#)	1947	(*)	(*)
R1250GS ADVENTURE	18' - 20'	FENDER WITH ALUMINIUM SUPPORT (#)	1947	(*)	(*)
R1200 R	18'	FENDER WITH ALUMINIUM SUPPORT (#)	3503	(*)	(*)
R1250 R	19' - 20'	FENDER WITH ALUMINIUM SUPPORT (#)	3503	(*)	(*)
R1250 RS	19' - 20'	FENDER WITH ALUMINIUM SUPPORT (#)	3503	(*)	(*)
R NINE T	14' - 20'	FENDER WITH ALUMINIUM SUPPORT (#)	7023	(*)	(*)
R NINE T URBAN G/S	17' - 20'	FENDER WITH ALUMINIUM SUPPORT (#)	7023	(*)	(*)
R NINE T PURE	17' - 20'	FENDER WITH ALUMINIUM SUPPORT (#)	7023	(*)	(*)
R NINE T RACER	17' - 20'	FENDER WITH ALUMINIUM SUPPORT (#)	7023	(*)	(*)
R NINE T SCRAMBLER	16' - 20'	FENDER WITH ALUMINIUM SUPPORT (#)	9464	(*)	(*)
DUCATI					
SCRAMBLER CAFE RACER	17' - 20'	FENDER S	9165	(*)	(*)
SCRAMBLER CLASSIC	15' - 20'	FENDER S	9165	(*)	(*)
SCRAMBLER FLAT TRACK PRO	16'	FENDER S	9165	(*)	(*)
SCRAMBLER FULL THROTTLE	15' - 20'	FENDER S	9165	(*)	(*)
SCRAMBLER ICON	15' - 20'	FENDER S	9165	(*)	(*)
SCRAMBLER 800 ICON DARK	20'	FENDER S	9165	(*)	(*)
HONDA					
CB500F	13' - 18'	FENDER S	6354	(*)	(*)
CB500F	19' - 20'	FENDER S	3557	(*)	(*)
CB500X	13' - 18'	FENDER S	6354	(*)	(*)
CB500X	19' - 20'	FENDER S	3557	(*)	(*)
CB600F HORNET	02' - 06'	FENDER S	1523	(*)	(*)
CB600F HORNET	07' - 15'	FENDER S	4403	(*)	(*)
CB600F HORNET ABS	08'	FENDER S	4403	(*)	(*)
CB1000R	08' - 16'	FENDER S (NC)	4692	(*)	(*)



J
Matt black

C
Carbon look

NOTE: PREVIOUSLY VERIFY ANY INTERFERENCE BETWEEN OUR PRODUCT AND ANY OTHER ACCESSORY (OEM OR AFTERMARKET) ALREADY INSTALLED ON THE MOTORCYCLE.

(*) Check price with your distributor.

(D) Aluminium chainguard included.

(NC) Keep original chainguard.

(#) Rear hugger not compatible with OFF-ROAD tires.

IMPORTANT: Indicate code color after part#. Example 0973A

REAR FENDERS

HI-TECH PARTS | TYPE OF FENDER:

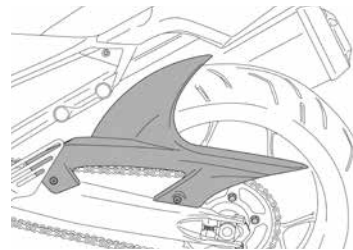

FENDER S



FENDER R

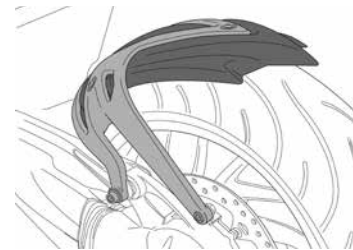

FENDER S WITH ALUMINIUM
SUPPORT

2021 MODELS: www.puig.tv

MODEL	YEAR	TYPE OF FENDER	REFERENCE	J	C
CB1000RA	08' - 16'	FENDER S (NC)	4692	(*)	(*)
CB1300	02' - 10'	FENDER S (D)	1638	(*)	(*)
CBF500	04' - 07'	FENDER S	4127	(*)	(*)
CBF600	04' - 07'	FENDER S	4127	(*)	(*)
CBF600	08' - 14'	FENDER S	4691	(*)	(*)
CBF600 ABS	04' - 07'	FENDER S	4127	(*)	(*)
CBF600 ABS	08' - 14'	FENDER S	4691	(*)	(*)
CBF600S	04' - 07'	FENDER S	4127	(*)	(*)
CBF600S	08' - 14'	FENDER S	4691	(*)	(*)
CBF600S ABS	04' - 07'	FENDER S	4127	(*)	(*)
CBF600S ABS	08' - 14'	FENDER S	4691	(*)	(*)
CBF1000	06' - 09'	FENDER S	4127	(*)	(*)
CBF1000	10' - 11'	FENDER S	4691	(*)	(*)
CBF1000 ABS	10' - 11'	FENDER S	4691	(*)	(*)
CBF1000F	10' - 16'	FENDER S	4691	(*)	(*)
CBF1000F ABS	10' - 16'	FENDER S	4691	(*)	(*)
CBR500R	13' - 18'	FENDER S	6354	(*)	(*)
CBR500R	19' - 20'	FENDER S	3557	(*)	(*)
CBR600F	99' - 07'	FENDER S	1436	(*)	(*)
CBR600F	11' - 13'	FENDER S	4403	(*)	(*)
CBR1000RR FIREBLADE	12' - 13'	FENDER R	6037		(*)
CBR1000RR FIREBLADE/SP	14' - 16'	FENDER R	6037		(*)
CBR1000RR FIREBLADE/SP	20'	FENDER R	20488	(*)	(*)
CBR1100XX	97' - 07'	FENDER S	1445	(*)	(*)
CRF1000L AFRICA TWIN	16' - 19'	FENDER S	3484	(*)	(*)
CRF1000L AFRICA TWIN ADVENTURE SPORTS	18' - 19'	FENDER S	3484	(*)	(*)
CRF1100L AFRICA TWIN	20'	FENDER S	3825	(*)	(*)
CRF1100L AFRICA TWIN ADVENTURE SPORTS	20'	FENDER S	3825	(*)	(*)
CROSSTOURER	12' - 18'	FENDER S	6334	(*)	(*)
CROSSTOURER DCT	12' - 18'	FENDER S	6334	(*)	(*)

2021 MODELS: www.puig.tv

MODEL	YEAR	TYPE OF FENDER	REFERENCE	J	C
INTEGRA 700	12' - 13'	FENDER S	6038	(*)	(*)
INTEGRA 750	14' - 20'	FENDER S	7047	(*)	(*)
INTEGRA 750S	14' - 16'	FENDER S	7047	(*)	(*)
NC700S/X	12' - 13'	FENDER S	6038	(*)	(*)
NC750S/X	14' - 20'	FENDER S	6038	(*)	(*)
VFR1200F	10' - 16'	FENDER S	5276	(*)	(*)
KAWASAKI					
ER-6N	05' - 08'	FENDER S	4092	(*)	(*)
ER-6N	12' - 16'	FENDER S	6041	(*)	(*)
ER-6F	06' - 08'	FENDER S	4092	(*)	(*)
ER-6F	12' - 16'	FENDER S	6041	(*)	(*)
NINJA 300	13' - 17'	FENDER S	6843	(*)	(*)
VERSYS 650	07' - 20'	FENDER S (NC)	4407	(*)	(*)
Z300	15' - 17'	FENDER S	6843	(*)	(*)
Z750	07' - 12'	FENDER S	4524	(*)	(*)
Z750R	11' - 12'	FENDER S	4431	(*)	(*)
Z750S	05' - 06'	FENDER S	4524	(*)	(*)
Z800	13' - 16'	FENDER S	6462	(*)	(*)
Z800E	13' - 16'	FENDER S	6462	(*)	(*)
Z1000	07' - 09'	FENDER S	4431	(*)	(*)
ZX-6R	09' - 16'	FENDER R	5014	(*)	(*)
ZX-6R	18' - 20'	FENDER R	5014	(*)	(*)
ZX-6R 636	13' - 16'	FENDER R	5014	(*)	(*)
ZX-10R	08' - 10'	FENDER R	4688	(*)	(*)
ZZR1400	12' - 20'	FENDER S	6043	(*)	(*)
KTM					
1090 ADVENTURE/R	17' - 20'	FENDER S	3670	(*)	(*)
1190 ADVENTURE/R	13' - 16'	FENDER S	3670	(*)	(*)
1290 SUPER ADVENTURE	15' - 16'	FENDER S	3670	(*)	(*)
1290 SUPER ADVENTURE R/S	17' - 20'	FENDER S	3670	(*)	(*)
1290 SUPER ADVENTURE T	17'	FENDER S	3670	(*)	(*)
SUZUKI					
DL250 V-STROM	17' - 20'	FENDER S	9592	(*)	(*)
DL650 V-STROM ABS	07' - 11'	FENDER S	4710	(*)	(*)
DL650 V-STROM	12' - 20'	FENDER S	4710	(*)	(*)
DL650XT V-STROM	15' - 20'	FENDER S	4710	(*)	(*)
DL1000 V-STROM	14' - 20'	FENDER S	6477	(*)	(*)
DL1000XT V-STROM	17' - 20'	FENDER S	6477	(*)	(*)



J
Matt black

C
Carbon look

NOTE: PREVIOUSLY VERIFY ANY INTERFERENCE BETWEEN OUR PRODUCT AND ANY OTHER ACCESSORY (OEM OR AFTERMARKET) ALREADY INSTALLED ON THE MOTORCYCLE.

(*) Check price with your distributor.
(D) Aluminium chainguard included.
(NC) Keep original chainguard.

(#) Rear hugger not compatible with OFF-ROAD tires.

IMPORTANT: Indicate code color after part#. Example 0973A

REAR FENDERS

HI-TECH PARTS | TYPE OF FENDER:

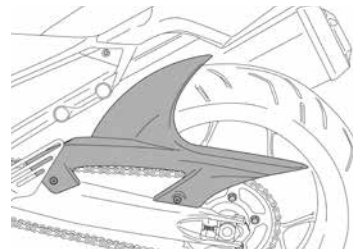

FENDER S



FENDER R

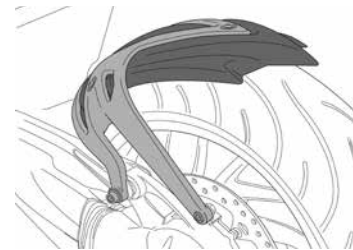

FENDER S WITH ALUMINIUM
SUPPORT

2021 MODELS: www.puig.tv

MODEL	YEAR	TYPE OF FENDER	REFERENCE	J	C
DL1050 V-STROM	20'	FENDER S	6477	(*)	(*)
D 1050XT V-STROM	20'	FENDER S	6477	(*)	(*)
GSF1200 BANDIT	96' - 05'	FENDER S	1462	(*)	(*)
GSF1200S BANDIT	96' - 05'	FENDER S	1462	(*)	(*)
GSF1250 BANDIT	07' - 13'	FENDER S	4409	(*)	(*)
GSF1250S BANDIT	07' - 13'	FENDER S	4409	(*)	(*)
GSF1250S BANDIT ABS	07' - 13'	FENDER S	4409	(*)	(*)
GSX1250F/FA	10' - 17'	FENDER S	4409	(*)	(*)
GSX1250F/FA ABS	10' - 17'	FENDER S	4409	(*)	(*)
GSX1400	01' - 06'	FENDER S (D)	1471	(*)	(*)
GSX-R600	04' - 05'	FENDER S	1643	(*)	(*)
GSX-R750	00' - 03'	FENDER S	1466	(*)	(*)
GSX-R750	04' - 05'	FENDER S	1643	(*)	(*)
GSX-R1000	03' - 04'	FENDER S	1466	(*)	(*)
GSX-R1000	09' - 16'	FENDER R	5059	(*)	(*)
GSX-R1000/R	17' - 20'	FENDER R	8999	(*)	(*)
GSX-R1300 HAYABUSA	08' - 17'	FENDER S	4693	(*)	(*)
SFV650 GLADIUS	09' - 15'	FENDER S	5019	(*)	(*)
SV650	16' - 20'	FENDER S	5019	(*)	(*)
SV650X	18' - 20'	FENDER S	5019	(*)	(*)
TRIUMPH					
TIGER 800/XC	11' - 14'	FENDER S	6040	(*)	(*)
TIGER 800 XC/XCX/XCA	15' - 20'	FENDER S	6040	(*)	(*)
TIGER 800 XR/XRX/XRT	15' - 20'	FENDER S	6040	(*)	(*)
TIGER 900	20'	FENDER S	20379	(*)	(*)
TIGER 900 GT	20'	FENDER S	20379	(*)	(*)
TIGER 900 GT LOW	20'	FENDER S	20379	(*)	(*)
TIGER 900 GT PRO	20'	FENDER S	20379	(*)	(*)
TIGER 900 RALLY	20'	FENDER S	20379	(*)	(*)
TIGER 900 RALLY PRO	20'	FENDER S	20379	(*)	(*)

2021 MODELS: www.puig.tv

MODEL	YEAR	TYPE OF FENDER	REFERENCE	J	C
TIGER EXPLORER	12' - 15'	FENDER WITH ALUMINIUM SUPPORT	6465	(*)	(*)
TIGER EXPLORER XC	13' - 15'	FENDER WITH ALUMINIUM SUPPORT	6465	(*)	(*)
TIGER EXPLORER XC/XR/XRX/XRT/XCX/XCA	16' - 20'	FENDER WITH ALUMINIUM SUPPORT	8595	(*)	(*)
YAMAHA					
MT-03	16' - 20'	FENDER S	8558	(*)	(*)
MT-07	14' - 20'	FENDER S	7048	(*)	(*)
MT-07 TRACER	16' - 19'	FENDER S	9205	(*)	(*)
MT-07 TRACER	20'	FENDER S	9205	(*)	(*)
MT-07 TRACER GT	19'	FENDER S	9205	(*)	(*)
TENERE 700	19' - 20'	FENDER S	3730	(*)	(*)
XJ6/DIVERSION	09' - 16'	FENDER S	5035	(*)	(*)
XJ6 DIVERSION F	10' - 16'	FENDER S	5035	(*)	(*)
XJR1200	94' - 98'	FENDER S (D)	1477	(*)	(*)
XJR1300	99' - 13'	FENDER S (D)	1477	(*)	(*)
XSR700	16' - 20'	FENDER S	7048	(*)	(*)
XSR700 XTRIBUTE	19' - 20'	FENDER S	7048	(*)	(*)
XT1200Z SUPER TÉNÉRÉ	10' - 20'	FENDER S	3567	(*)	(*)
YZF-R1	09' - 14'	FENDER R	5017	(*)	(*)
YZF-R1	15' - 20'	FENDER R	7688	(*)	(*)
YZF-R1M	17' - 20'	FENDER R	7688	(*)	(*)
YZF-R3	15' - 20'	FENDER S	8558	(*)	(*)



J
Matt black

C
Carbon look

NOTE: PREVIOUSLY VERIFY ANY INTERFERENCE BETWEEN OUR PRODUCT AND ANY OTHER ACCESSORY (OEM OR AFTERMARKET) ALREADY INSTALLED ON THE MOTORCYCLE.

(*) Check price with your distributor.

(D) Aluminium chainguard included.

(NC) Keep original chainguard.

(#) Rear hugger not compatible with OFF-ROAD tires.

IMPORTANT: Indicate code color after part#. Example 0973A

REAR FENDER EXTENSION

HI-TECH PARTS | TECHNICAL SECTION



FUNCTIONAL

It improves the protection of the original fender.



MATERIAL

Manufactured in ABS material. It attaches through adhesive and mechanical processes and plastic rivets.



REF. 9911J



J
Matt black

REAR FENDER EXTENSION

HI-TECH PARTS

2021 MODELS: www.puig.tv			
MODEL	YEAR	REF.	J
BENELLI			
LEONCINO 500	15' - 20'	9905	(*)
LEONCINO TRAIL	15' - 20'	9905	(*)
BMW			
F900 R	20'	20302	(*)
F900 XR	20'	20302	(*)
S1000 R	09' - 20'	9885	(*)
S1000 RR	09' - 18'	9885	(*)
S1000 RR	19' - 20'	3726	(*)
S1000 XR	15' - 19'	3665	(*)
S1000 XR	20'	20478	(*)
DUCATI			
MONSTER 821	14' - 20'	9886	(*)
SUPERSPORT 939/S	17' - 20'	9887	(*)
HONDA			
CB125R NEO SPORTS CAFÉ	18' - 20'	3514	(*)
CB300R NEO SPORTS CAFÉ	18' - 20'	3514	(*)
CB650R NEO SPORTS CAFÉ	19' - 20'	3725	(*)
CB1000R NEO SPORTS CAFE	18' - 20'	1803	(*)
CBR600RR	08' - 12'	9888	(*)
CBR650R	19' - 20'	3725	(*)
CBR1000RR FIREBLADE	08' - 11'	9889	(*)
CBR1000RR FIREBLADE	13' - 20'	9891	(*)
HUSQVARNA			
SVARTPILEN 401	18' - 20'	3676	(*)
VITPILEN 401	18' - 20'	3676	(*)
KAWASAKI			
ER-6N	09' - 11'	9892	(*)
ER-6F	09' - 11'	9892	(*)
NINJA 250R	13'	9896	(*)
NINJA 300	13' - 20'	9896	(*)
NINJA 650	17' - 20'	9790	(*)
NINJA 1000 SX	20'	9894	(*)
VERSYS-X 300	17' - 20'	9895	(*)

2021 MODELS: www.puig.tv			
MODEL	YEAR	REF.	J
VERSYS 1000	12' - 18'	3515	(*)
VERSYS 1000	19' - 20'	3677	(*)
Z250	13' - 16'	9896	(*)
Z300	13' - 20'	9896	(*)
Z400	17' - 20'	1811	(*)
Z650	17' - 20'	9790	(*)
Z800E	12' - 16'	9897	(*)
Z800	12' - 16'	9897	(*)
Z900	17' - 20'	0022	(*)
Z900RS	18' - 20'	0022	(*)
Z900RS CAFE	18' - 20'	0022	(*)
Z1000	10' - 16'	9893	(*)
Z1000SX	10' - 16'	9893	(*)
Z1000/SX	17' - 19'	9894	(*)
ZX-10R	17' - 20'	1939	(*)
KTM			
125 DUKE	12' - 16'	9899	(*)
125 DUKE	17' - 20'	1882	(*)
200 DUKE	12' - 16'	9899	(*)
390 DUKE	12' - 16'	9899	(*)
390 DUKE	17' - 20'	1882	(*)
690 DUKE	12' - 20'	9900	(*)
690 DUKE R	12' - 20'	9900	(*)
790 DUKE	18' - 20'	0024	(*)
1290 SUPERDUKE R	14' - 19'	9898	(*)
1290 SUPERDUKE R	20'	20479	(*)
1290 SUPERDUKE GT	16' - 20'	9898	(*)
SUZUKI			
GSR750	11' - 16'	9902	(*)
GSX-R600	06' - 07'	9903	(*)
GSX-R750	06' - 07'	9903	(*)
GSX-S750	17' - 20'	9901	(*)
GSX-S1000	15' - 20'	9904	(*)
GSX-S1000F	15' - 20'	9904	(*)

2021 MODELS: www.puig.tv			
MODEL	YEAR	REF.	J
TRIUMPH			
STREET TRIPLE	17' - 20'	9906	(*)
STREET TRIPLE R	17' - 20'	9906	(*)
STREET TRIPLE S	17' - 20'	9906	(*)
STREET TRIPLE RS	17' - 20'	9906	(*)
TIGER 1050	07' - 11'	9907	(*)
TIGER SPORT	13' - 20'	9908	(*)
YAMAHA			
FZ1	06' - 14'	9909	(*)
FZ1 FAZER	06' - 14'	9909	(*)
FZ8	10' - 15'	9909	(*)
FZ8 FAZER	10' - 15'	9909	(*)
FAZER8	10' - 15'	9909	(*)
MT-07	13' - 17'	9911	(*)
MT-07	18' - 20'	9912	(*)
MT-07 TRACER	16' - 20'	9912	(*)
MT-09	13' - 20'	9910	(*)
MT-09 SP	18' - 20'	9910	(*)
MT-09 TRACER	15' - 17'	9910	(*)
MT-09 TRACER	18' - 20'	0016	(*)
MT-09 TRACER GT	18' - 20'	0016	(*)
MT-10	16' - 20'	3508	(*)
XSR700	16' - 20'	9911	(*)
XSR 900	16' - 20'	9910	(*)
YZF-R1	15' - 20'	9913	(*)
YZF-R6	05' - 20'	9914	(*)
SPARE			
PLASTIC RIVET		20526N	(*)



J
Matt black

MANUFACTURED IN ABS MATERIAL. IT ATTACHES THROUGH ADHESIVE AND MECHANICAL PROCESSES AND PLASTIC RIVETS. ONLY SUITABLE FOR OEM FENDER.

(*) Check price with your distributor.

IMPORTANT: Indicate code color after part#. Example: 0973A.



J
Matt black

MANUFACTURED IN ABS MATERIAL. IT ATTACHES THROUGH ADHESIVE AND MECHANICAL PROCESSES AND PLASTIC RIVETS. ONLY SUITABLE FOR OEM FENDER.

(*) Check price with your distributor.

IMPORTANT: Indicate code color after part#. Example: 0973A.

SINGLE-SIDED REAR FENDER

HI-TECH PARTS | TECHNICAL SECTION



FUNCTIONAL

Protects the motorcycle and the rider from water, mud and small rocks.



MATERIAL

Manufactured from machined aluminium with chamfered edge.



ADJUSTABLE

Dimmable and adjustable.



WEIGHT

Light and resistant.
Manufactured in aluminium.



REF. 20397J

MODEL	YEAR	REFERENCE	J
HONDA			
CRF1100L AFRICA TWIN	20'	20397	(*)
CRF1100L AFRICA TWIN ADVENTURE SPORTS	20'	20397	(*)
BMW			
F750GS	18' - 20'	3691	(*)
F850GS	18' - 20'	3691	(*)
F850GS ADVENTURE	19' - 20'	3691	(*)



J
Matt black

(*) Check price with your distributor.
IMPORTANT: Indicate code color after part#. Example: 0973A.

FENDER EXTENSIONS

HI-TECH PARTS | TECHNICAL SECTION

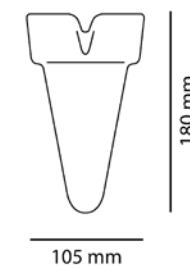

// URBAN UNIVERSAL

MODEL	REF.	N
URBAN UNIVERSAL	6413	(*)

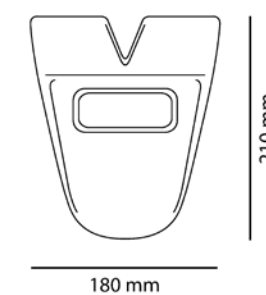

// TOUR UNIVERSAL

MODEL	REF.	N
TOUR UNIVERSAL	6412	(*)

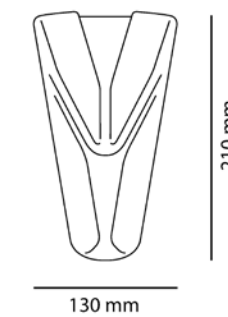

// URBAN HONDA

MODEL	REF.	N
URBAN HONDA NC700X/S - INTEGRA	6428	(*)

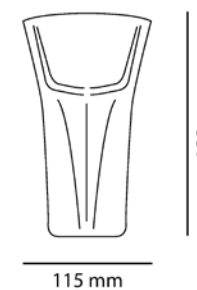

// TOUR YAMAHA

MODEL	REF.	N
TOUR YAMAHA FZ1/FZ8	6427	(*)

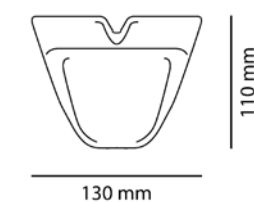

// SPORT UNIVERSAL

MODEL	REF.	N
SPORT UNIVERSAL	6414	(*)

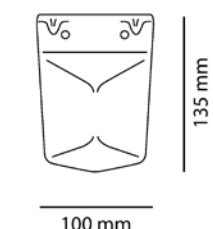

// TOUR DUCATI

MODEL	REF.	N
TOUR DUCATI	6675	(*)

N
BlackMANUFACTURED IN ABS PLASTIC. IT IS SUPPLIED WITH
3M STICKER TO N-BLACK FIX IT TO THE HUGGER.

(*) Check price with your distributor.

IMPORTANT: Indicate code color after part#. Example: 0973A.

ALUMINIUM FRONT FENDER

HI-TECH PARTS | TECHNICAL SECTION



REF. 9992N



REF. 3688N

2021 MODELS: www.puig.tv

MODEL	YEAR	MATERIAL	REF.	N
HARLEY DAVIDSON				
SPORTSTER 883 IRON	09' - 20'	MILLED ALUMINIUM	9992	(*)
SPORTSTER 883 IRON	09' - 20'	MILLED SHEET	3688	(*)
HONDA				
CMX 300 REBEL	17' - 20'	MILLED SHEET	3525	(*)
CMX 500 REBEL	17' - 20'	MILLED SHEET	3525	(*)
INDIAN				
SCOUT	15' - 20'	MILLED ALUMINIUM	9739	(*)
SCOUT BOBBER	18' - 20'	MILLED ALUMINIUM	20296	(*)
KAWASAKI				
VULCAN S	15' - 20'	MILLED ALUMINIUM	9673	(*)
VULCAN S	15' - 20'	MILLED SHEET	3817	(*)
VULCAN S CAFE	17' - 20'	MILLED ALUMINIUM	9673	(*)
VULCAN S CAFE	17' - 20'	MILLED SHEET	3817	(*)
UNIVERSAL				
METALLIC SHEET FRONT FENDER			3735N	(*)

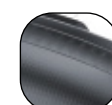
N
Black(*) Check price with your distributor.
IMPORTANT: Indicate code color after part#. Example: 0973A.

FRONT FENDER EXTENSION

HI-TECH PARTS | TECHNICAL SECTION

**FUNCTIONAL**

It improves the protection of the original fender.

**MATERIAL**

Manufactured in ABS material. It attaches through adhesive and mechanical processes and plastic rivets.



REF. 5786N

**N**
Black

FRONT FENDER EXTENSION

HI-TECH PARTS

2021 MODELS: www.puig.tv			
MODEL	YEAR	REF.	N
APRILIA			
CAPONORD 1200	13' - 17'	20472	(*)
CAPONORD 1200 RALLY	15' - 17'	9284	(*)
MANA 850	07' - 16'	9940	(*)
RSV4 R	13' - 14'	20472	(*)
RSV4 RF	15' - 20'	20472	(*)
RSV4 RR	15' - 20'	20472	(*)
SHIVER 750	08' - 20'	5798	(*)
SHIVER 900	17' - 20'	20472	(*)
BENELLI			
LEONCINO 500	15' - 20'	3516	(*)
LEONCINO TRAIL	15' - 20'	3516	(*)
BMW			
F650 GS	08' - 12'	5783	(*)
F650 GS	02' - 07'	6177	(*)
F700 GS	12' - 17'	6821	(*)
F750 GS	18' - 20'	1941	(*)
F800 GS	08' - 18'	5785	(*)
F800 R	09' - 14'	5786	(*)
F800 S	06' - 10'	5786	(*)
F800 ST	06' - 13'	5786	(*)
F800 R	15' - 18'	9020	(*)
F800 GT	13' - 20'	5786	(*)
F850 GS	18' - 20'	1942	(*)
F850 GS ADVENTURE	19' - 20'	1942	(*)
F900 R	20'	20303	(*)
F900 XR	20'	20303	(*)
G310GS	17' - 20'	9916	(*)
G310R	17' - 20'	9812	(*)
G650 GS	09' - 16'	6177	(*)
K1200 S	04' - 08'	6172	(*)
K1200R	05' - 08'	9814	(*)
K1200GT	06' - 08'	6168	(*)
K1300 S	08' - 16'	6172	(*)

2021 MODELS: www.puig.tv			
MODEL	YEAR	REF.	N
K1300R	09' - 15'	9814	(*)
K1300GT	09' - 11'	6168	(*)
K1600 GT	11' - 19'	6168	(*)
K1600 GTL	11' - 19'	6168	(*)
R850R	94' - 99'	9813	(*)
R850R	94' - 99'	6429	(*)
R850C/GS	95' - 07'	6167	(*)
R1100 GS	94' - 99'	9813	(*)
R1100 RT	96' - 01'	6167	(*)
R1100 R	94' - 00'	6429	(*)
R1100S	99' - 05'	6430	(*)
R1150 GS	99' - 05'	6164	(*)
R1150 RT	01' - 05'	6167	(*)
R1200 C	97' - 05'	6431	(*)
R1200 GS/ ADVENTURE	04' - 12'	5784	(*)
R1200 GS	13' - 18'	6822	(*)
R1200 GS	13' - 18'	9202 (+)	(*)
R1200 GS ADVENTURE	13' - 18'	6822	(*)
R1200 GS ADVENTURE	13' - 18'	9202 (+)	(*)
R1200GS EXCLUSIVE	13' - 20'	9202 (+)	(*)
R1200GS RALLYE	13' - 20'	9202 (+)	(*)
R1200 R	05' - 10'	5661	(*)
R1200 R	11' - 14'	9021	(*)
R1200 R	15' - 18'	9022	(*)
R1200 RS	15' - 18'	9203 (*)	(*)
R1200 RT	05' - 13'	6160	(*)
R1200 RT	14' - 18'	8487	(*)
R1250 R	19' - 20'	9022	(*)
R1250GS	19' - 20'	6822	(*)
R1250GS	19' - 20'	9202 (+)	(*)
R1250GS ADVENTURE	19' - 20'	6822	(*)
R1250GS ADVENTURE	19' - 20'	9202 (+)	(*)
R1250 RT	19' - 20'	20358	(*)
R1250 RS	19' - 20'	9203	(*)

2021 MODELS: www.puig.tv			
MODEL	YEAR	REF.	N
R NINE T	14' - 20'	8186	(*)
R NINE T RACER	14' - 20'	8186	(*)
R NINE T SCRAMBLER	14' - 20'	8186	(*)
R NINE T SCRAMBLER	16' - 20'	9815	(*)
R NINE T URBAN G/S	17' - 20'	3895	(*)
S1000 R	14' - 20'	8084	(*)
S1000 RR	10' - 18'	8084	(*)
S1000 RR	19' - 20'	3896	(*)
S1000 XR	15' - 19'	8084	(*)
S1000 XR	20'	20303	(*)
DUCATI			
DIAVEL	11' - 15'	6178	(*)
MONSTER 696	08' - 12'	6415	(*)
MONSTER 796	10' - 13'	6415	(*)
MONSTER 1100/S	09' - 13'	6415	(*)
MONSTER 1100 EVO	09' - 13'	6415	(*)
MONSTER 1200/S	14' - 20'	3897	(*)
MULTISTRADA 1200/S	10' - 20'	6416	(*)
MULTISTRADA 1200 ENDURO	16' - 20'	9816	(*)
MULTISTRADA 950	17' - 20'	9816	(*)
SCRAMBLER ICON	14' - 20'	9023	(*)
SCRAMBLER SIXTY2	14' - 20'	9023	(*)
HARLEY DAVIDSON			
XL/FXDB/FXDL/FXDS/FXD/FXDXT/FXDC			
/FXDWG/XLH/FXSTD/FXST/FXDXT/FXSTC		6170	(*)
XR 1200	08' - 20'	6175	(*)
XR 1200X	08' - 20'	6175	(*)
X-R/V-ROD	08' - 10'	6175	(*)
HONDA			
CMX 500 REBEL	17' - 20'	9819	(*)
CB125R NEO SPORTS CAFE	18' - 20'	3678	(*)
CB300R NEO SPORTS CAFE	18' - 20'	3678	(*)
CB500F	13' - 20'	7339	(*)
CB500X	13' - 18'	7339	(*)

2021 MODELS: www.puig.tv			
MODEL	YEAR	REF.	N
CB500X	19' - 20'	3679	(*)
CB600F HORNET	11' - 13'	6426	(*)
CB600F HORNET	98' - 04'	6171	(*)
CB650F	14' - 18'	8488	(*)
CB900F HORNET	02' - 07'	6171	(*)
CB1100	13' - 20'	9820	(*)
CB1100EX	13' - 20'	9820	(*)
CB1000R	08' - 17'	9821	(*)
CB1000R NEO SPORTS CAFE	18' - 20'	0049	(*)
CB1100 RS	17' - 20'	9822	(*)
CBF500	04' - 06'	5800	(*)
CBF600	04' - 10'	5800	(*)
CBF600S	04' - 10'	5800	(*)
CBF1000F	10' - 16'	5800	(*)
CBF1000	06' - 11'	5800	(*)
CBR300R	15' - 20'	3901	(*)
CBR500R	13' - 20'	7339	(*)
CBR600F	11' - 13'	6426	(*)
CBR650R	19' - 20'	3680	(*)
CB650R NEO SPORTS CAFE	19' - 20'	3680	(*)
CBR650F	14' - 18'	8488	(*)
CBR1000F	93' - 98'	5801	(*)
CBR1100XX BLACKBIRD	96' - 07'	6432	(*)
CBRF1000L AFRICA TWIN	16' - 19'	9169	(*)
CBRF1000L AFRICA TWIN ADVENTURE SPORTS	18' - 19'	9169	(*)
CBRF1100L AFRICA TWIN	20'	9375	(*)
CBRF1100L AFRICA TWIN ADVENTURE SPORTS	20'	9375	(*)
CBR1000RR FIREBLADE	04' - 05'	9917	(*)
CBR1000RR FIREBLADE	06' - 07'	9918	(*)
CBR1000RR FIREBLADE	08' - 20'	8163	(*)
CROSSRUNNER	11' - 14'	6179	(*)
CROSSRUNNER	15' - 20'	8163	(*)
CROSSTOURER DCT	12' - 20'	6417	(*)
CTX1300 DX	14' - 20'	9823	(*)



N
Black

MANUFACTURED IN ABS MATERIAL.
IT ATTACHES THROUGH ADHESIVE AND MECHANICAL PROCESSES AND PLASTIC RIVETS.

(*) Fixation with glue.
(+) Bigger extension. Check image on our site.
(*) Check price with your distributor.

IMPORTANT: Indicate code color after part#. Example: 0973A.



N
Black

MANUFACTURED IN ABS MATERIAL.
IT ATTACHES THROUGH ADHESIVE AND MECHANICAL PROCESSES AND PLASTIC RIVETS.

(*) Fixation with glue.
(+) Bigger extension. Check image on our site.
(*) Check price with your distributor.

IMPORTANT: Indicate code color after part#. Example: 0973A.

FRONT FENDER EXTENSION

HI-TECH PARTS

2021 MODELS: www.puig.tv			
MODEL	YEAR	REF.	N
GL1800 GOLD WING	18' - 20'	3900	(*)
INTEGRA 700	12' - 13'	6302	(*)
INTEGRA 750	14' - 16'	6302	(*)
MSX125	13' - 15'	9817	(*)
MSX125	16' - 20'	9818	(*)
NC700X/S	12' - 20'	6418	(*)
NT650V DEAUVILLE	98' - 06'	5801	(*)
NT700V DEAUVILLE	06' - 11'	5801	(*)
NM4 VULTUS	14' - 20'	9823	(*)
ST1300 PAN-EUROPEAN	02' - 16'	5805	(*)
VFR750F	91' - 97'	5801	(*)
VFR800	02' - 13'	5803	(*)
VFR800F	14' - 20'	8163	(*)
VFR1200F	10' - 17'	5804	(*)
VTR1000 SP-1	00' - 01'	9919	(*)
VTR1000 SP-2	02' - 06'	9919	(*)
XL650V TRANSALP	01' - 07'	9920	(*)
XL700V TRANSALP	08' - 13'	5802	(*)
XL1000V VARADERO	98' - 13'	5799	(*)
X-ADV	17' - 20'	9824	(*)
HUSQVARNA			
SVARTPILEN 401	18' - 20'	3681	(*)
VITPILEN 401	18' - 20'	3681	(*)
VITPILEN 701	18' - 20'	3684	(*)
INDIAN			
SCOUT	15' - 20'	9825 (*)	(*)
KAWASAKI			
ER-6F/N	09' - 11'	6419	(*)
ER-6F/N	12' - 15'	6420	(*)
GTR1400	06' - 20'	6163	(*)
NINJA 250R	08' - 14'	9921	(*)
NINJA H2 SX	18' - 20'	9865	(*)
NINJA 300	13' - 20'	3517	(*)
NINJA 400	17' - 20'	1940	(*)

2021 MODELS: www.puig.tv			
MODEL	YEAR	REF.	N
NINJA 650	17' - 20'	9827	(*)
NINJA 1000 SX	20'	20473	(*)
VERSYS X-300	17' - 20'	9922	(*)
VERSYS 650	06' - 09'	5778	(*)
VERSYS 650	10' - 20'	5779	(*)
VERSYS 1000	10' - 20'	5779	(*)
VULCAN S	15' - 20'	9024	(*)
Z300	15' - 20'	3517	(*)
Z400	19' - 20'	1940	(*)
Z650	17' - 20'	9827	(*)
Z750	03' - 12'	6419	(*)
Z750	07' - 12'	5781	(*)
Z750S	03' - 12'	6419	(*)
Z750R	11' - 13'	6422	(*)
Z800/E	13' - 16'	6423	(*)
Z900	17' - 20'	9828	(*)
Z900RS	17' - 20'	3518	(*)
Z1000	03' - 06'	6419	(*)
Z1000	03' - 06'	6419	(*)
Z1000	07' - 09'	5780	(*)
Z1000	10' - 14'	5782	(*)
Z1000	15' - 20'	8489	(*)
Z1000SX	11' - 20'	6423	(*)
ZX-6R 636	03' - 04'	6419	(*)
ZX-6R 636	05' - 08'	9923	(*)
ZX-6R 636	13' - 17'	6423	(*)
ZX-10R	04' - 07'	9923	(*)
ZX-10R	08' - 10'	9924	(*)
ZX-10R	11' - 16'	6423	(*)
ZX-10R/RR	17' - 20'	9865	(*)
ZZR1200	02' - 05'	9925	(*)
ZZR1400	06' - 20'	6163	(*)
KTM			
125 DUKE	11' - 16'	9926	(*)

2021 MODELS: www.puig.tv			
MODEL	YEAR	REF.	N
125 DUKE	17' - 20'	9927	(*)
200 DUKE	11' - 16'	9926	(*)
390 DUKE	11' - 16'	9926	(*)
390 DUKE	17' - 20'	9927	(*)
690 DUKE	08' - 11'	9928	(*)
690 DUKE	12' - 17'	3519	(*)
690 DUKE R	08' - 11'	9928	(*)
690 DUKE R	12' - 17'	3519	(*)
790 DUKE	18' - 20'	9929	(*)
790 ADVENTURE/R	19' - 20'	3682	(*)
990 ADVENTURE	03' - 12'	6169	(*)
1050 ADVENTURE	13' - 16'	9026	(*)
1090 ADVENTURE/R	16' - 20'	20475	(*)
1190 ADVENTURE	13' - 16'	9026	(*)
1290 SUPERDUKE R	14' - 19'	9025	(*)
1290 SUPERDUKE R	20'	20474	(*)
1290 SUPEDUKE GT	16' - 20'	9025	(*)
1290 SUPER ADVENTURE R	16' - 20'	20475	(*)
KYMCO			
AK550	18' - 20'	3683	(*)
PIAGGIO			
GTS 125	08' - 20'	20476	(*)
GTS 300	08' - 20'	20476	(*)
SUZUKI			
BURGMAN 400	07' - 17'	9829	(*)
BURGMAN 650	02' - 11'	9830	(*)
BURGMAN 650	12' - 20'	9831	(*)
B-KING	07' - 12'	9934	(*)
DL250 V-STROM	17' - 20'	0030	(*)
DL650 V-STROM	04' - 11'	5791	(*)
DL650 V-STROM	12' - 20'	6159	(*)
DL650XT V-STROM	12' - 20'	6159	(*)
DL1000XT V-STROM	04' - 11'	5791	(*)
DL1000 V-STROM	02' - 08'	5791	(*)

2021 MODELS: www.puig.tv			
MODEL	YEAR	REF.	N
DL1000 V-STROM	14' - 20'	3663	(*)
GSF600S BANDIT	00' - 04'	6433	(*)
GSF650 BANDIT	09' - 16'	5789	(*)
GSF650 BANDIT	05' - 08'	5787	(*)
GSF650S BANDIT	09' - 16'	5789	(*)
GSF650S BANDIT	05' - 08'	5787	(*)
GSF1200 BANDIT	06' - 16'	5787	(*)
GSF1200S BANDIT	06' - 16'	5787	(*)
GSF1200S BANDIT	01' - 05'	6433	(*)
GSF1250 BANDIT	10' - 16'	5789	(*)
GSF1250S BANDIT	10' - 16'	5789	(*)
GSF1250 BANDIT	06' - 16'	5787	(*)
GSF1250S BANDIT	06' - 16'	5787	(*)
GSR600	06' - 08'	5792	(*)
GSR750	11' - 16'	6176	(*)
GSX650F	08' - 12'	5787	(*)
GSX650F	08' - 17'	5790	(*)
GSX1250F	10' - 17'	5790	(*)
GSX1250 FA	10' - 16'	5787	(*)
GSX-R125/250	17' - 20'	9930	(*)
GSX-R600	01' - 03'	9936	(*)
GSX-R600	04' - 05'	9937	(*)
GSX-R600	11' - 17'	9938	(*)
GSX-R750	00' - 02'	9936	(*)
GSX-R750	03' - 05'	9937	(*)
GSX-R750	11' - 17'	9938	(*)
GSX-R1000	01' - 02'	9936	(*)
GSX-R1000	03' - 04'	9937	(*)
GSX-R1000	09' - 16'	9938	(*)
GSX-R1000/R	17' - 20'	9931	(*)
GSX-R1300 HAYABUSA	99' - 07'	9932	(*)
GSX-R1300 HAYABUSA	99' - 17'	9933	(*)
GSX-S1000	15' - 20'	8493	(*)
GSX-S1000F	15' - 20'	8493	(*)



N
Black

MANUFACTURED IN ABS MATERIAL.
IT ATTACHES THROUGH ADHESIVE AND MECHANICAL PROCESSES AND PLASTIC RIVETS.

(*) Fixation with glue.
(*) Bigger extension. Check image on our site.
(*) Check price with your distributor.

IMPORTANT: Indicate code color after part#. Example: 0973A.



N
Black

MANUFACTURED IN ABS MATERIAL.
IT ATTACHES THROUGH ADHESIVE AND MECHANICAL PROCESSES AND PLASTIC RIVETS.

(*) Fixation with glue.
(*) Bigger extension. Check image on our site.
(*) Check price with your distributor.

IMPORTANT: Indicate code color after part#. Example: 0973A.

FRONT FENDER EXTENSION

HI-TECH PARTS

2021 MODELS: www.puig.tv			
MODEL	YEAR	REF.	N
KATANA	19' - 20'	3724	(*)
SV650	03' - 15'	6165	(*)
SV650S	03' - 15'	6165	(*)
SFV650 GLADIUS	09' - 15'	9832	(*)
SV650	16' - 20'	9285	(*)
TRIUMPH			
BONNEVILLE BOBBER	17' - 20'	3899	(*)
BONNEVILLE SPEEDMASTER	18' - 20'	3899	(*)
BONNEVILLE SE	09' - 20'	6435	(*)
BONNEVILLE T100/T120	16' - 20'	9833	(*)
DAYTONA 675	06' - 11'	5788	(*)
DAYTONA 675 R	06' - 11'	5788	(*)
ROCKET 3	07' - 19'	3902	(*)
SCRAMBLER	06' - 20'	9287	(*)
STREET TRIPLE	06' - 11'	5788	(*)
STREET TRIPLE R	06' - 11'	5788	(*)
STREET TRIPLE	17' - 20'	3898	(*)
STREET TWIN	16' - 20'	9224	(*)
SPEED TRIPLE	11' - 15'	6424	(*)
SPEED TRIPLE	16' - 20'	3898	(*)
SPEED TRIPLE R	11' - 15'	6424	(*)
SPEED TRIPLE R	16' - 20'	3898	(*)
SPEED TRIPLE/R	06' - 10'	6161	(*)
SPEED TWIN	19' - 20'	3862	(*)
SPEEDMASTER	18' - 20'	3899	(*)
THRUXTON	04' - 16'	9287	(*)
TIGER 800 XR/XRT/XRX	11' - 20'	6173	(*)
TIGER 800 XC/XCX/XCA	11' - 20'	9288	(*)
TIGER 900	20'	20403	(*)
TIGER 900 GT	20'	20403	(*)
TIGER 900 GT LOW	20'	20403	(*)
TIGER 900 GT PRO	20'	20403	(*)
TIGER 900 RALLY	20'	20477	(*)
TIGER 900 RALLY PRO	20'	20477	(*)

2021 MODELS: www.puig.tv			
MODEL	YEAR	REF.	N
TIGER 1050	07' - 12'	6161	(*)
TIGER SPORT	13' - 20'	9128	(*)
TIGER EXPLORER XR/XRX/XRT	12' - 15'	6425	(*)
TIGER EXPLORER XC/XCX/XCA	12' - 15'	6425	(*)
TIGER EXPLORER XC/XRX/XRT/XCX/XCA	17'	9223	(*)
YAMAHA			
FJR1300A/AS	06' - 20'	6166	(*)
FAZER8	10' - 15'	5795	(*)
FZ6	06' - 07'	5795	(*)
FZ6	04' - 05'	5796	(*)
FZ6 FAZER	06' - 07'	5795	(*)
FZ6 FAZER	04' - 05'	5796	(*)
FZ6 FAZER S2	08' - 09'	5794	(*)
FZ6 S2	08' - 09'	5794	(*)
FZ8	10' - 15'	5795	(*)
FZ8 FAZER	10' - 15'	5795	(*)
FZS1000 FAZER	01' - 05'	5795	(*)
MT-03	16' - 20'	9182	(*)
MT-07	14' - 17'	7565	(*)
MT-07	18' - 20'	0031	(*)
MT-07 TRACER	15' - 19'	9237	(*)
MT-07 TRACER	20'	20470	(*)
MT-09	13' - 20'	7512	(*)
MT-09 SP	18' - 20'	7512	(*)
MT-09 TRACER GT	18' - 20'	7512	(*)
MT-09 TRACER	15' - 20'	7512	(*)
MT-10	16' - 20'	9835	(*)
MT-10 SP	16' - 20'	9835	(*)
MT-125	14' - 20'	9834	(*)
TDM 900	02' - 11'	5797	(*)
TENERE 700	19' - 20'	3894	(*)
T-MAX 530	12' - 20'	3666	(*)
TRX850	95' - 00'	6434	(*)
XJ6	09' - 16'	5796	(*)

2021 MODELS: www.puig.tv			
MODEL	YEAR	REF.	N
XJ6 DIVERSION	09' - 16'	5796	(*)
XJ6 DIVERSION F	09' - 16'	5796	(*)
XJR1200	95' - 99'	6434	(*)
XJR1300	99' - 16'	6434	(*)
XT660Z TÉNÉRÉ	08' - 16'	9836	(*)
XT1200Z SUPER TÉNÉRÉ	10' - 20'	6162	(*)
X-MAX 125	18' - 20'	3664	(*)
X-MAX 300	17' - 20'	3664	(*)
X-MAX 400	17' - 20'	3664	(*)
XSR700	16' - 20'	9183	(*)
XSR900	16' - 20'	9184	(*)
XV950	13' - 16'	9289	(*)
XV950R	13' - 16'	9289	(*)
YZF-R125	08' - 13'	9935	(*)
YZF-R125	14' - 20'	9834	(*)
YZF-R1	09' - 20'	9835	(*)
YZF-R3	16' - 20'	9182	(*)
YZF-R6	03' - 05'	5795	(*)
SPARE			
PLASTIC RIVET		20526N	(*)



N
Black

MANUFACTURED IN ABS MATERIAL.
IT ATTACHES THROUGH ADHESIVE AND MECHANICAL PROCESSES AND PLASTIC RIVETS.

(*) Fixation with glue.
(†) Bigger extension. Check image on our site.
(*) Check price with your distributor.

IMPORTANT: Indicate code color after part#. Example: 0973A.



N
Black

MANUFACTURED IN ABS MATERIAL.
IT ATTACHES THROUGH ADHESIVE AND MECHANICAL PROCESSES AND PLASTIC RIVETS.

(*) Fixation with glue.
(†) Bigger extension. Check image on our site.
(*) Check price with your distributor.

IMPORTANT: Indicate code color after part#. Example: 0973A.

AXLE SLIDERS PHB19

HI-TECH PARTS | TECHNICAL SECTION

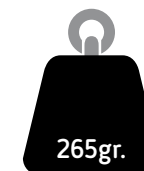

WEIGHT
265 grams.



DESIGN
Racing look for your motorcycle.

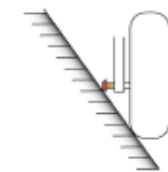

COMPLETE PROTECTION
Fork and swing arm protection.

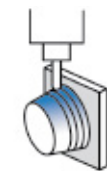

MATERIAL
Manufactured through a nylon block.

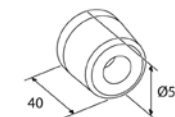

DIMENSIONS

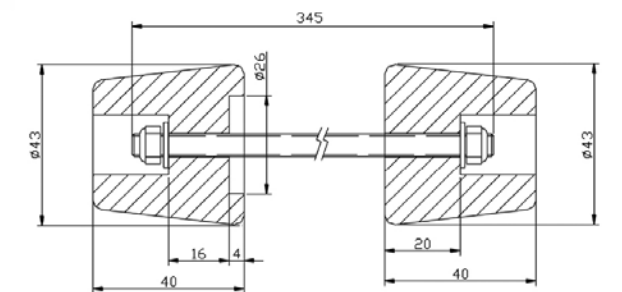

MODEL	REF.	N
UNIVERSAL	20097	(*)

SPARES	REF.	N	A	T	O	P	R	V
NYLON MOD. UNIVERSAL RIGHT SIDE	20098	(*)						
NYLON MOD. UNIVERSAL LEFT SIDE	20099	(*)						
SET OF ANODIZED ALUMINIUM RINGS	20025	(*)						(*)
ANODIZED ALUMINIUM RING SET FOR AXLE SLIDER	20271	(*)						(*)

(*) Check price with your distributor.

IMPORTANT: Indicate code color after part#. Example: 0973A.

Check availability for motorcycle models at www.puig.tv typing in the searching window



The set of anodized aluminium rings must be ordered separately from the sliders, depending on the color of the bike.



VALVES

HI-TECH PARTS | TECHNICAL SECTION

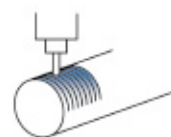

MATERIAL
Manufactured through billet aluminium.

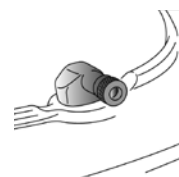

DESIGN
Developed to ease the inflation process.

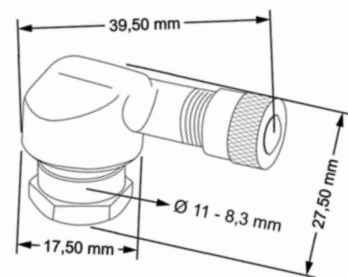

WEIGHT
8 grams.



A Blue G Yellow N Black P Silver R Red V Green T Orange

MODEL	Ø WHEEL HOLE	REF.	A G N P R V T
UNIVERSAL BY PAIR	11 mm.	5591	(*)
UNIVERSAL BY PAIR	8,3 mm.	8100	(*)

REF. 5591V



(*) Check price with your distributor.
IMPORTANT: Indicate code color after part#. Example: 0973A.



TENSORS FOR REAR WHEEL BY PAIR

HI-TECH PARTS | TECHNICAL SECTION

MODEL	YEAR	REF.	N
KYMCO			
AK550	17' - 20'	9545	(*)
YAMAHA			
T-MAX 530	12' - 16'	7357	(*)
T-MAX 530/DX/SX	17' - 19'	7357	(*)
T-MAX 560 /SX/DX/MAX TECH	20'	7357	(*)

REF. 7357N

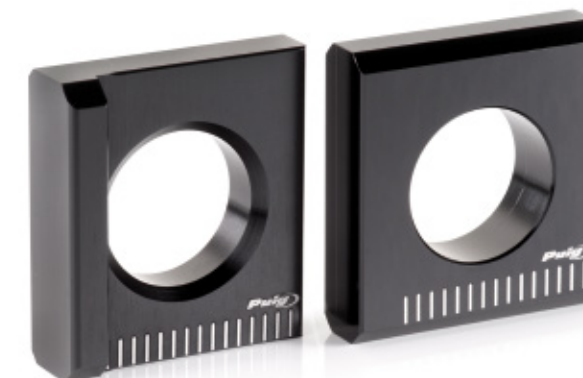

N Black

(*) Check price with your distributor.
IMPORTANT: Indicate code color after part#. Example: 0973A.

ADHESIVE STRIPS

HI-TECH PARTS



YELLOW
FLUORESCENT

STRIP WITHOUT APLICATOR	PRICE
2568G	(*)
STRIP WITH APLICATOR	PRICE
4542G	(*)



YELLOW
REFLECTIVE

STRIP WITHOUT APLICATOR	PRICE
25680	(*)
STRIP WITH APLICATOR	PRICE
45420	(*)



BLUE
REFLECTIVE

STRIP WITHOUT APLICATOR	PRICE
2568A	(*)
STRIP WITH APLICATOR	PRICE
4542A	(*)



WHITE
REFLECTIVE

STRIP WITHOUT APLICATOR	PRICE
2568B	(*)
STRIP WITH APLICATOR	PRICE
4542B	(*)



PURE
WHITE

STRIP WITHOUT APLICATOR	PRICE
2568M	(*)
STRIP WITH APLICATOR	PRICE
4542M	(*)



CARBON
LOOK

STRIP WITHOUT APLICATOR	PRICE
2568C	(*)
STRIP WITH APLICATOR	PRICE
4542C	(*)



ORANGE
FLUORESCENT

STRIP WITHOUT APLICATOR	PRICE
2568T	(*)
STRIP WITH APLICATOR	PRICE
4542T	(*)



ORANGE
REFLECTIVE

STRIP WITHOUT APLICATOR	PRICE
2568X	(*)
STRIP WITH APLICATOR	PRICE
4542X	(*)



MATT
BLACK

STRIP WITHOUT APLICATOR	PRICE
2568N	(*)
STRIP WITH APLICATOR	PRICE
4542N	(*)



GOLD

STRIP WITHOUT APLICATOR	PRICE
2568Z	(*)
STRIP WITH APLICATOR	PRICE
4542Z	(*)



SILVER

STRIP WITHOUT APLICATOR	PRICE
2568P	(*)
STRIP WITH APLICATOR	PRICE
4542P	(*)

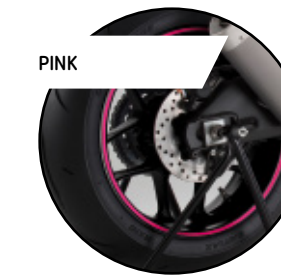

PINK

STRIP WITHOUT APLICATOR	PRICE
2568Q	(*)
STRIP WITH APLICATOR	PRICE
4542Q	(*)



GREEN
FLUORESCENT

STRIP WITHOUT APLICATOR	PRICE
2568V	(*)
STRIP WITH APLICATOR	PRICE
4542V	(*)



PURPLE

STRIP WITHOUT APLICATOR	PRICE
2568L	(*)
STRIP WITH APLICATOR	PRICE
4542L	(*)

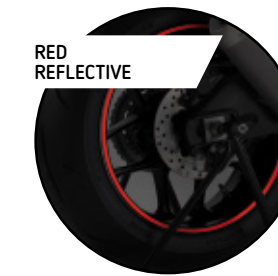

RED
REFLECTIVE

STRIP WITHOUT APLICATOR	PRICE
2568R	(*)
STRIP WITH APLICATOR	PRICE
4542R	(*)

STRIP SIZE
7 mm. WIDTH x 6 m. LENGTH.
TO BE APPLIED ON THE WHEEL
FROM 16" TO 18"

(*) Check price with your distributor.
IMPORTANT: Indicate code color after
part#. Example 0973A

ADHESIVE STRIPS PREMIUM HI-TECH PARTS



MODEL	REF.	PRICE
YELLOW FLUORESCENT	8431G	(*)



MODEL	REF.	PRICE
BLUE FLUORESCENT	8431A	(*)



MODEL	REF.	PRICE
WHITE FLUORESCENT	8431B	(*)



MODEL	REF.	PRICE
ORANGE FLUORESCENT	8431T	(*)



MODEL	REF.	PRICE
RED FLUORESCENT	8431R	(*)



MODEL	REF.	PRICE
GREEN FLUORESCENT	8431V	(*)



THE SET CONSISTS ON 8 RIM STRIPS, FOR 14" AND 21" RIMS.
MATERIAL: PVC LENTICULAR SEMI RIGID APPLIED ON RIMS OF 14" TO 21".

(*) Check price with your distributor.

IMPORTANT: Indicate code color after part#. Example 0973A

SPECIAL RIM STRIPS

HI-TECH PARTS



THE SET CONSISTS ON 8 RIM STRIPS. FOR 14" AND 21" RIMS.
 MATERIAL: PVC LENTICULAR SEMI RIGID APPLIED ON RIMS OF 14" TO 21".



9133A		9134G		9311B		9293B	
9133B		9134R		9311T		9293A	
9133R		9134V		9311V		9293R	
9133P		5528V		9290B		9293P	
5524A		5528B		9290T		9630P	
5524B		5527R		9290V		9630R	
5524R		9136A		5545B		9630A	
5989B		9136R		5545T		96300	
5989R		9136P		5545V		5532B	
5525A		9135A		6561B		55320	
5525B		9135P		6561T		5532P	
5525P		9135R		6561V		5531A	
9442A		5529B		9291B		5531B	
9442R		5529P		9291T		5531G	
5526P		9292A		9291V		5531P	
5559B		9292B		7590B		5531R	
5559P		9292R		7590T		55310	
5530P		9292V		7590V		5531V	
						9985P	

SPECIAL RIM STRIPS

HI-TECH PARTS

2021 MODELS: www.puig.tv			
MODEL	YEAR	REF.	PRICE
BMW			
R NINE T	14' - 20'	9133	(*)
R NINE T SCRAMBLER	16' - 20'	9133	(*)
R NINE T PURE	17' - 20'	9133	(*)
R NINE T RACER	17' - 20'	9133	(*)
R NINE T URBAN G/S	17' - 20'	9133	(*)
DUCATI			
MONSTER 696	08' - 14'	5527	(*)
MONSTER 796	10' - 14'	5527	(*)
MONSTER 797	17' - 20'	5527	(*)
MONSTER 821	14' - 20'	5527	(*)
MONSTER 1100	09' - 10'	5527	(*)
MONSTER 1100 EVO	11' - 13'	5527	(*)
MONSTER 1200/S	14' - 20'	5527	(*)
MONSTER 1200 R	16' - 20'	5527	(*)
SCRAMBLER ICON/CLASSIC/FULL THROTTLE	15' - 20'	9134	(*)
SCRAMBLER SIXTY2	16' - 20'	9134	(*)
SCRAMBLER URBAN ENDURO	15' - 16'	9134	(*)
SCRAMBLER FLAT TRACK PRO	16'	9134	(*)
SCRAMBLER DESERT SLED	17' - 20'	9134	(*)
SCRAMBLER CAFE RACER	17' - 20'	9134	(*)
SCRAMBLER 1100	18' - 20'	9134	(*)
SCRAMBLER 1100 SPORT	18' - 20'	9134	(*)
SCRAMBLER 1100 SPECIAL	18' - 20'	9134	(*)
HONDA			
CB600F HORNET	98' - 16'	5526	(*)
CB900F HORNET	02' - 05'	5526	(*)
CBR250R	11' - 14'	5524	(*)
CBR500R	13' - 18'	5524	(*)
CBR600F	86' - 07'	5524	(*)
CBR600F	11' - 13'	5524	(*)
CBR650F	14' - 16'	5524	(*)
CBR650F	17' - 18'	5524	(*)
CBR600RR	03' - 06'	5524	(*)

2021 MODELS: www.puig.tv			
MODEL	YEAR	REF.	PRICE
CBR600RR	07' - 16'	5524	(*)
CBR900RR FIRE BLADE	96' - 99'	5524	(*)
CBR900RR FIRE BLADE	00' - 01'	5524	(*)
CBR900RR FIRE BLADE	02' - 03'	5524	(*)
CBR1000RR FIREBLADE	04' - 07'	5524	(*)
CBR1000RR FIREBLADE	08' - 11'	5524	(*)
CBR1000RR FIREBLADE	12' - 16'	5524	(*)
CBR1000RR FIREBLADE/SP/SP2	17' - 20'	5524	(*)
SCOOPIY 80		5559	(*)
SCOOPIY SH50		5559	(*)
SCOOPIY SH100		5559	(*)
SCOOPIY SH125	02' - 06'	5559	(*)
SCOOPIY SH125i	07' - 08'	5559	(*)
SCOOPIY SH125i (rear brake disk)	09' - 10'	5559	(*)
SCOOPIY SH125i (rear brake disk)	11' - 12'	5559	(*)
SCOOPIY SH125i	13' - 16'	5559	(*)
SCOOPIY SH125i	17' - 20'	5559	(*)
SCOOPIY SH150	02' - 06'	5559	(*)
SCOOPIY SH150i	07' - 08'	5559	(*)
SCOOPIY SH150i (rear brake disk)	09' - 10'	5559	(*)
SCOOPIY SH150i (rear brake disk)	11' - 12'	5559	(*)
SCOOPIY SH150i	13' - 16'	5559	(*)
SCOOPIY SH150i	17' - 20'	5559	(*)
SCOOPIY SH300i	07' - 10'	5559	(*)
SCOOPIY SH300i	11' - 14'	5559	(*)
SCOOPIY SH300i	15' - 17'	5559	(*)
KAWASAKI			
ER-6F	06' - 16	9311	(*)
ER-6N	06' - 16'	9311	(*)
NINJA H2	15' - 20'	5528	(*)
NINJA 250R	08' - 12'	5528	(*)
NINJA 250SL	15' - 16'	5528	(*)
NINJA 300	13' - 17'	5528	(*)
NINJA 400	18' - 20'	5528	(*)

2021 MODELS: www.puig.tv			
MODEL	YEAR	REF.	PRICE
YAMAHA			
NINJA 650	17' - 20'	5528	(*)
Z650	17' - 20'	9290	(*)
Z750	04' - 06'	5545	(*)
Z750	07' - 12'	5545	(*)
Z750R	11' - 12'	5545	(*)
Z800	13' - 16'	6561	(*)
Z800E	13' - 16'	6561	(*)
Z900	17' - 20'	9291	(*)
Z900RS	18' - 20'	9291	(*)
Z1000	03' - 16'	7590	(*)
Z1000/R	17' - 20'	7590	(*)
Z1000SX	11' - 20'	7590	(*)
ZX-6R	94' - 16'	9292	(*)
ZX-6R	00' - 04'	9292	(*)
ZX-6R	05' - 06'	9292	(*)
ZX-6R	07' - 16'	9292	(*)
ZX-6R	18' - 20'	9292	(*)
ZX-6R 636	13' - 16'	9292	(*)
ZX-9R	98' - 04'	9292	(*)
ZX-9R	00' - 04'	9292	(*)
ZX-10R	04' - 20'	9292	(*)
ZX-10RR	17' - 20'	9292	(*)
ZX-10R SE	18' - 20'	9292	(*)
ZX-12R	00' - 06'	9292	(*)
KYMCO			
AK550	17' - 20'	9630	(*)
SUZUKI			
GSR600	06' - 11'	5989	(*)
GSR750	11' - 16'	5989	(*)
GSX-R125	17' - 20'	5525	(*)
GSX-R250	17' - 20'	5525	(*)
GSX-R600	96' - 17'	5525	(*)
GSX-R750	96' - 17'	5525	(*)
GSX-R1000	01' - 16'	5525	(*)

2021 MODELS: www.puig.tv			
MODEL	YEAR	REF.	PRICE
GSX-R1000/R	17' - 20'	5525	(*)
GSX-R1300 HAYABUSA	99' - 07'	5525	(*)
GSX-S125	17' - 20'	9442	(*)
GSX-S750	17' - 20'	9442	(*)
GSX-S1000	15' - 20'	9442	(*)
GSX-S1000F	15' - 20'	9442	(*)
YAMAHA			
MT-07	14' - 20'	9136	(*)
MT-07 TRACER	16' - 20'	9136	(*)
MT-07 TRACER	14' - 20'	9293	(*)
MT-07 TRACER GT	19'	9136	(*)
MT-07 TRACER GT	19'	9293	(*)
MT-09	13' - 16'	9135	(*)
MT-09	17' - 20'	9135	(*)
MT-09 SP	18' - 20'	9135	(*)
MT-09 TRACER	15' - 20'	9135	(*)
MT-09 TRACER GT	18' - 20'	9135	(*)
MT-09 TRACER	15' - 20'	9293	(*)
MT-09 TRACER GT	18' - 20'	9293	(*)
XSR700	16' - 20'	9985	(*)
XSR700 XTRIBUTE	19' - 20'	9985	(*)
XSR900	16' - 20'	9985	(*)
YZF-R1	99' - 20'	5529	(*)
YZF-R1M	17' - 20'	5529	(*)
YZF-R6	99' - 20'	5530	(*)
T-MAX 500	08' - 11'	5532	(*)
T-MAX 530	12' - 16	5532	(*)
T-MAX 530/DX/SX	17' - 19'	5532	(*)
T-MAX 560 /SX/DX/MAX TECH	20'	5532	(*)
UNIVERSAL			
RACING		5531	(*)

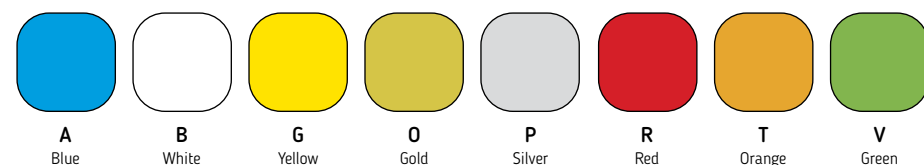

(*) Check price with your distributor.
IMPORTANT: Indicate code color after part#. Example 0973A

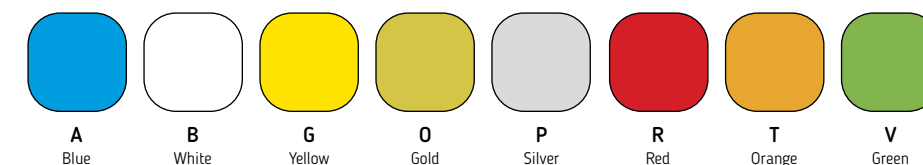

(*) Check price with your distributor.
IMPORTANT: Indicate code color after part#. Example 0973A



RIM STRIPS GS

HI-TECH PARTS | TECHNICAL SECTION



MODEL	YEAR	REF.	O N B
BMW			
R1200GS	13' - 18'	20150	(*)
R1200GS ADVENTURE	14' - 18'	20151	(*)
R1200GS EXCLUSIVE	17' - 18'	20150	(*)
R1200GS RALLYE	17' - 18'	20150	(*)
R1250GS ADVENTURE	18' - 20'	20151	(*)
R1250GS HP	18' - 20'	20150	(*)
R1250GS	18' - 20'	20150	(*)
S1000 XR	15' - 19'	20214	(*)

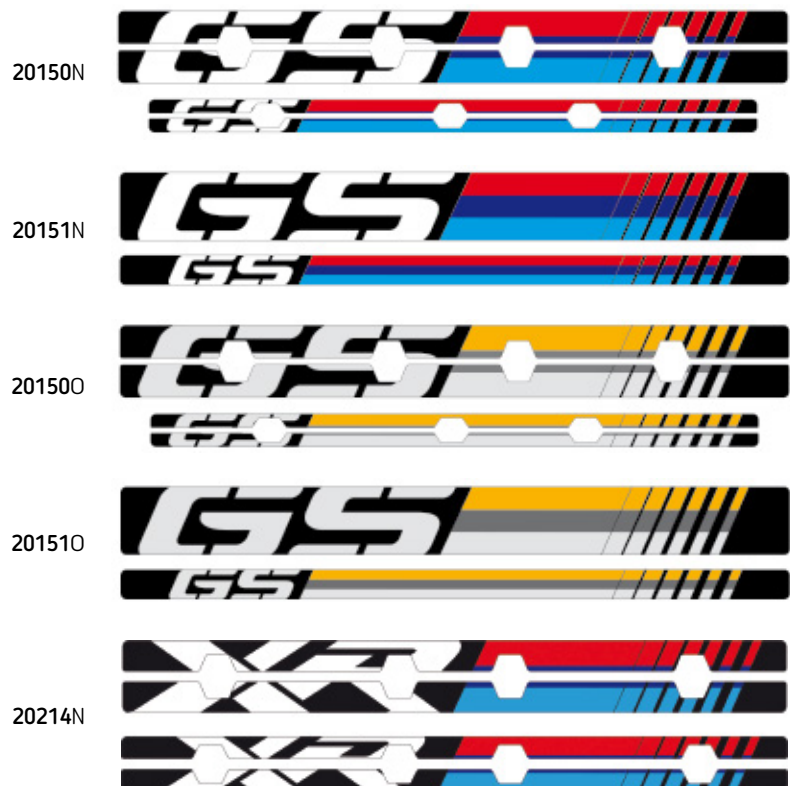

SWING ARM PROTECTOR GS

HI-TECH PARTS | TECHNICAL SECTION



MODEL	YEAR	REF.	O N B
BMW			
R1200GS	04' - 12'	20152	(*)
R1200GS	13' - 18'	20153	(*)
R1200GS ADVENTURE	06' - 13'	20152	(*)
R1200GS ADVENTURE	14' - 18'	20153	(*)
R1200GS EXCLUSIVE	17' - 18'	20153	(*)
R1200GS RALLYE	17' - 18'	20153	(*)
R1250GS	18' - 20'	20153	(*)
R1250GS ADVENTURE	18' - 20'	20153	(*)
R1250GS HP	18' - 20'	20153	(*)
DUCATI			
MULTISTRADA 1200 ENDURO/PRO	16' - 18'	20213	(*)
MULTISTRADA 1260 ENDURO	19' - 20'	20213	(*)



ADHESIVE KIT FOR BMW CASES

HI-TECH PARTS | TECHNICAL SECTION

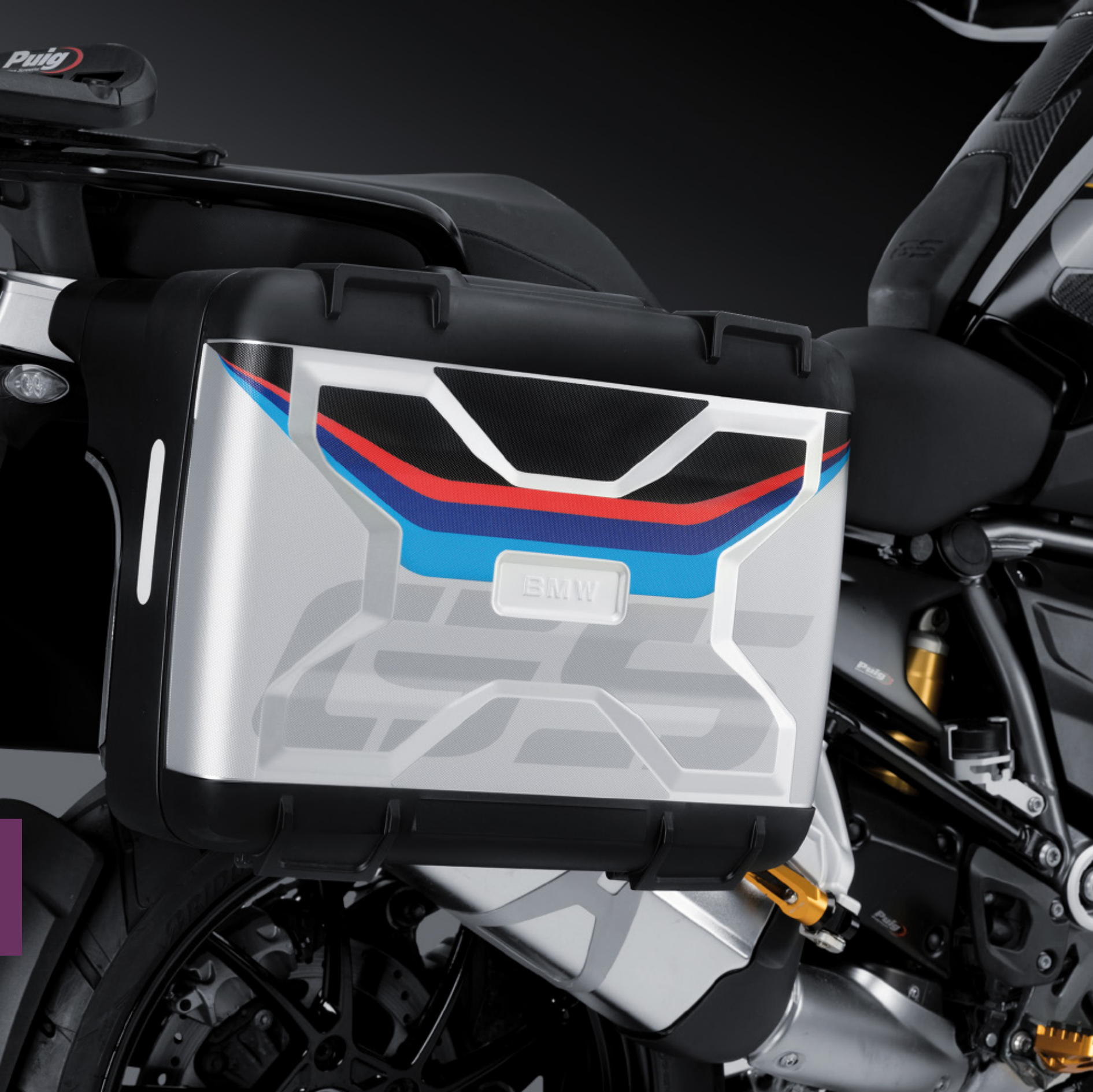

REF. 20216N



REF. 20217N



REF. 20227N



REF. 20228N



REF. 20229N



REF. 20230N



REF. 20231N



REF. 20232N



N
Black

THE KIT INCLUDES ADHESIVES FOR ONE CASE. IF YOU HAVE THREE CASES, YOU MUST ORDER 3 UNITS OF THE REFERENCE.

(*) Check price with your distributor.

IMPORTANT: Indicate code color after part#. Example: 0973A.

ADHESIVE KIT FOR BMW CASES

HI-TECH PARTS

2021 MODELS: www.puig.tv

MODEL	YEAR	CASE MODEL	REF.	N
BMW				
F700GS	12' - 17'	SIDE CASE VARIO GS	20216	(*)
F700GS	12' - 17'	SIDE CASE VARIO NAVIGATOR	20227	(*)
F700GS	12' - 17'	CASE TOPCASE VARIO GS	20229	(*)
F700GS	12' - 17'	CASE TOPCASE VARIO NAVIGATOR	20230	(*)
F700GS	12' - 17'	SIDE CASE ADVENTURE GS	20217	(*)
F700GS	12' - 17'	SIDE CASE ADVENTURE NAVIGATOR	20228	(*)
F700GS	12' - 17'	CASE TOPCASE ADVENTURE GS	20231	(*)
F700GS	12' - 17'	CASE TOPCASE ADVENTURE NAVIGATOR	20232	(*)
F750GS	18' - 20'	SIDE CASE VARIO GS	20216	(*)
F750GS	18' - 20'	SIDE CASE VARIO NAVIGATOR	20227	(*)
F750GS	18' - 20'	CASE TOPCASE VARIO GS	20229	(*)
F750GS	18' - 20'	CASE TOPCASE VARIO NAVIGATOR	20230	(*)
F750GS	18' - 20'	SIDE CASE ADVENTURE GS	20217	(*)
F750GS	18' - 20'	SIDE CASE ADVENTURE NAVIGATOR	20228	(*)
F750GS	18' - 20'	CASE TOPCASE ADVENTURE GS	20231	(*)
F750GS	18' - 20'	CASE TOPCASE ADVENTURE NAVIGATOR	20232	(*)
F800GS	08' - 17'	SIDE CASE VARIO GS	20216	(*)
F800GS	08' - 17'	SIDE CASE VARIO NAVIGATOR	20227	(*)
F800GS	08' - 17'	CASE TOPCASE VARIO GS	20229	(*)
F800GS	08' - 17'	CASE TOPCASE VARIO NAVIGATOR	20230	(*)
F800GS	08' - 17'	SIDE CASE ADVENTURE GS	20217	(*)
F800GS	08' - 17'	SIDE CASE ADVENTURE NAVIGATOR	20228	(*)
F800GS	08' - 17'	CASE TOPCASE ADVENTURE GS	20231	(*)
F800GS	08' - 17'	CASE TOPCASE ADVENTURE NAVIGATOR	20232	(*)
F850GS	18' - 20'	SIDE CASE VARIO GS	20216	(*)
F850GS	18' - 20'	SIDE CASE VARIO NAVIGATOR	20227	(*)
F850GS	18' - 20'	CASE TOPCASE VARIO GS	20229	(*)
F850GS	18' - 20'	CASE TOPCASE VARIO NAVIGATOR	20230	(*)
F850GS	18' - 20'	SIDE CASE ADVENTURE GS	20217	(*)
F850GS	18' - 20'	SIDE CASE ADVENTURE NAVIGATOR	20228	(*)
F850GS	18' - 20'	CASE TOPCASE ADVENTURE GS	20231	(*)
F850GS	18' - 20'	CASE TOPCASE ADVENTURE NAVIGATOR	20232	(*)
F850GS ADVENTURE	19' - 20'	SIDE CASE VARIO GS	20216	(*)



N
Black

THE KIT INCLUDES STICKERS FOR ONE CASE. IF YOU HAVE 3 CASES, YOU MUST ASK FOR 3 UNITS FROM THIS REFERENCE.

(*) Check price with your distributor.

IMPORTANT: Indicate code color after part#. Example: 0973A.

2021 MODELS: www.puig.tv

MODEL	YEAR	CASE MODEL	REF.	N
F850GS ADVENTURE	19' - 20'	SIDE CASE VARIO NAVIGATOR	20227	(*)
F850GS ADVENTURE	19' - 20'	CASE TOPCASE VARIO GS	20229	(*)
F850GS ADVENTURE	19' - 20'	CASE TOPCASE VARIO NAVIGATOR	20230	(*)
F850GS ADVENTURE	19' - 20'	SIDE CASE ADVENTURE GS	20217	(*)
F850GS ADVENTURE	19' - 20'	SIDE CASE ADVENTURE NAVIGATOR	20228	(*)
F850GS ADVENTURE	19' - 20'	CASE TOPCASE ADVENTURE GS	20231	(*)
F850GS ADVENTURE	19' - 20'	CASE TOPCASE ADVENTURE NAVIGATOR	20232	(*)
R1200GS	04' - 12'	SIDE CASE VARIO GS	20216	(*)
R1200GS	04' - 12'	SIDE CASE VARIO NAVIGATOR	20227	(*)
R1200GS	04' - 12'	CASE TOPCASE VARIO GS	20229	(*)
R1200GS	04' - 12'	CASE TOPCASE VARIO NAVIGATOR	20230	(*)
R1200GS	04' - 12'	SIDE CASE ADVENTURE GS	20217	(*)
R1200GS	04' - 12'	SIDE CASE ADVENTURE NAVIGATOR	20228	(*)
R1200GS	04' - 12'	CASE TOPCASE ADVENTURE GS	20231	(*)
R1200GS	04' - 12'	CASE TOPCASE ADVENTURE NAVIGATOR	20232	(*)
R1200GS	13' - 18'	SIDE CASE VARIO GS	20216	(*)
R1200GS	13' - 18'	SIDE CASE VARIO NAVIGATOR	20227	(*)
R1200GS	13' - 18'	CASE TOPCASE VARIO GS	20229	(*)
R1200GS	13' - 18'	CASE TOPCASE VARIO NAVIGATOR	20230	(*)
R1200GS	13' - 18'	SIDE CASE ADVENTURE GS	20217	(*)
R1200GS	13' - 18'	SIDE CASE ADVENTURE NAVIGATOR	20228	(*)
R1200GS	13' - 18'	CASE TOPCASE ADVENTURE GS	20231	(*)
R1200GS	13' - 18'	CASE TOPCASE ADVENTURE NAVIGATOR	20232	(*)
R1200GS EXCLUSIVE	17' - 18'	SIDE CASE VARIO GS	20216	(*)
R1200GS EXCLUSIVE	17' - 18'	SIDE CASE VARIO NAVIGATOR	20227	(*)
R1200GS EXCLUSIVE	17' - 18'	CASE TOPCASE VARIO GS	20229	(*)
R1200GS EXCLUSIVE	17' - 18'	CASE TOPCASE VARIO NAVIGATOR	20230	(*)
R1200GS EXCLUSIVE	17' - 18'	SIDE CASE ADVENTURE GS	20217	(*)
R1200GS EXCLUSIVE	17' - 18'	SIDE CASE ADVENTURE NAVIGATOR	20228	(*)
R1200GS EXCLUSIVE	17' - 18'	CASE TOPCASE ADVENTURE GS	20231	(*)
R1200GS EXCLUSIVE	17' - 18'	CASE TOPCASE ADVENTURE NAVIGATOR	20232	(*)
R1200GS RALLYE	17' - 18'	SIDE CASE VARIO GS	20216	(*)
R1200GS RALLYE	17' - 18'	SIDE CASE VARIO NAVIGATOR	20227	(*)
R1200GS RALLYE	17' - 18'	CASE TOPCASE VARIO GS	20229	(*)
R1200GS RALLYE	17' - 18'	CASE TOPCASE VARIO NAVIGATOR	20230	(*)
R1200GS RALLYE	17' - 18'	SIDE CASE ADVENTURE GS	20217	(*)
R1200GS RALLYE	17' - 18'	SIDE CASE ADVENTURE NAVIGATOR	20228	(*)
R1200GS RALLYE	17' - 18'	CASE TOPCASE ADVENTURE GS	20231	(*)



N
Black

THE KIT INCLUDES STICKERS FOR ONE CASE. IF YOU HAVE 3 CASES, YOU MUST ASK FOR 3 UNITS FROM THIS REFERENCE.

(*) Check price with your distributor.

IMPORTANT: Indicate code color after part#. Example: 0973A.

ADHESIVE KIT FOR BMW CASES

HI-TECH PARTS

2021 MODELS: www.puig.tv

MODEL	YEAR	CASE MODEL	REF.	N
R1200GS RALLYE	17' - 18'	CASE TOPCASE ADVENTURE NAVIGATOR	20232	(*)
R1200GS ADVENTURE	06' - 13'	SIDE CASE VARIO GS	20216	(*)
R1200GS ADVENTURE	06' - 13'	SIDE CASE VARIO NAVIGATOR	20227	(*)
R1200GS ADVENTURE	06' - 13'	CASE TOPCASE VARIO GS	20229	(*)
R1200GS ADVENTURE	06' - 13'	CASE TOPCASE VARIO NAVIGATOR	20230	(*)
R1200GS ADVENTURE	06' - 13'	SIDE CASE ADVENTURE GS	20217	(*)
R1200GS ADVENTURE	06' - 13'	SIDE CASE ADVENTURE NAVIGATOR	20228	(*)
R1200GS ADVENTURE	06' - 13'	CASE TOPCASE ADVENTURE GS	20231	(*)
R1200GS ADVENTURE	06' - 13'	CASE TOPCASE ADVENTURE NAVIGATOR	20232	(*)
R1200GS ADVENTURE	14' - 18'	SIDE CASE VARIO GS	20216	(*)
R1200GS ADVENTURE	14' - 18'	SIDE CASE VARIO NAVIGATOR	20227	(*)
R1200GS ADVENTURE	14' - 18'	CASE TOPCASE VARIO GS	20229	(*)
R1200GS ADVENTURE	14' - 18'	CASE TOPCASE VARIO NAVIGATOR	20230	(*)
R1200GS ADVENTURE	14' - 18'	SIDE CASE ADVENTURE GS	20217	(*)
R1200GS ADVENTURE	14' - 18'	SIDE CASE ADVENTURE NAVIGATOR	20228	(*)
R1200GS ADVENTURE	14' - 18'	CASE TOPCASE ADVENTURE GS	20231	(*)
R1200GS ADVENTURE	14' - 18'	CASE TOPCASE ADVENTURE NAVIGATOR	20232	(*)
R1250GS	18' - 20'	SIDE CASE VARIO GS	20216	(*)
R1250GS	18' - 20'	SIDE CASE VARIO NAVIGATOR	20227	(*)
R1250GS	18' - 20'	CASE TOPCASE VARIO GS	20229	(*)
R1250GS	18' - 20'	CASE TOPCASE VARIO NAVIGATOR	20230	(*)
R1250GS	18' - 20'	SIDE CASE ADVENTURE GS	20217	(*)
R1250GS	18' - 20'	SIDE CASE ADVENTURE NAVIGATOR	20228	(*)
R1250GS	18' - 20'	CASE TOPCASE ADVENTURE GS	20231	(*)
R1250GS	18' - 20'	CASE TOPCASE ADVENTURE NAVIGATOR	20232	(*)
R1250GS HP	18' - 20'	SIDE CASE VARIO GS	20216	(*)
R1250GS HP	18' - 20'	SIDE CASE VARIO NAVIGATOR	20227	(*)
R1250GS HP	18' - 20'	CASE TOPCASE VARIO GS	20229	(*)
R1250GS HP	18' - 20'	CASE TOPCASE VARIO NAVIGATOR	20230	(*)
R1250GS HP	18' - 20'	SIDE CASE ADVENTURE GS	20217	(*)
R1250GS HP	18' - 20'	SIDE CASE ADVENTURE NAVIGATOR	20228	(*)
R1250GS HP	18' - 20'	CASE TOPCASE ADVENTURE GS	20231	(*)
R1250GS HP	18' - 20'	CASE TOPCASE ADVENTURE NAVIGATOR	20232	(*)
R1250GS ADVENTURE	18' - 20'	SIDE CASE VARIO GS	20216	(*)

THE KIT INCLUDES STICKERS FOR ONE CASE. IF YOU HAVE 3 CASES, YOU MUST ASK FOR 3 UNITS FROM THIS REFERENCE.

(*) Check price with your distributor.

IMPORTANT: Indicate code color after part#. Example: 0973A.

N
Black2021 MODELS: www.puig.tv

MODEL	YEAR	CASE MODEL	REF.	N
R1250GS ADVENTURE	18' - 20'	SIDE CASE VARIO NAVIGATOR	20227	(*)
R1250GS ADVENTURE	18' - 20'	CASE TOPCASE VARIO GS	20229	(*)
R1250GS ADVENTURE	18' - 20'	CASE TOPCASE VARIO NAVIGATOR	20230	(*)
R1250GS ADVENTURE	18' - 20'	SIDE CASE ADVENTURE GS	20217	(*)
R1250GS ADVENTURE	18' - 20'	SIDE CASE ADVENTURE NAVIGATOR	20228	(*)
R1250GS ADVENTURE	18' - 20'	CASE TOPCASE ADVENTURE GS	20231	(*)
R1250GS ADVENTURE	18' - 20'	CASE TOPCASE ADVENTURE NAVIGATOR	20232	(*)

THE KIT INCLUDES STICKERS FOR ONE CASE. IF YOU HAVE 3 CASES, YOU MUST ASK FOR 3 UNITS FROM THIS REFERENCE.

(*) Check price with your distributor.

IMPORTANT: Indicate code color after part#. Example: 0973A.

N
Black

STAND SUPPORTS

HI-TECH PARTS



MODEL	REF.	N
STAND SUPPORT OFF-ROAD BASIC	6289N (#)	(*)

MODEL	REF.	N
STAND SUPPORT OFF-ROAD HYDRAULIC	6290N (#)	(*)

MODEL	REF.	N
BASE PARK&MOVE FOR CENTER STAND	9974N (&)	(*)

MODEL	REF.	N
FRONT STAND	4348N	(*)

MODEL	REF.	N
FRONT HEAD STAND. INCLUDE AXIS: 13 mm., 15 mm., 16,5 mm., 17 mm., 18 mm.,	5601N	(*)

(#) Height on the lower position 310 mm. Height on the highest position 400 mm. Maximum load: 200kg

(#) Height on the lower position 310 mm. Height on the highest position 400 mm. Maximum load: 200kg

(&) Maximum load: 200kg.



MODEL	REF.	N
STAND WHEEL LOCK 17" TO 21"	6071N	(*)

MODEL	REF.	N
REAR STAND FOR TWIN SWING ARMS	4322N	(*)

Include pair adaptors for spool and pair of pads for swing arm.

SPARES	REF.	P
SET OF HOOKS FOR THE REAR STAND IN SILVER	5333P	(*)
ACCESSORIES FOR SWING ARM REAR STAND	4349P	(*)

MODEL	REF.	N
REAR STAND FOR SINGLE SWING ARM TRANSMISSION LEFT SIDE AXIS INCLUDED. (1)	CHECK OUR WEBSITE	
REAR STAND FOR SINGLE SWING ARM TRANSMISSION RIGHT SIDE AXIS INCLUDED.	CHECK OUR WEBSITE	

Check availability for motorcycle models at www.puig.tv typing in the searching window

SINGLE ARM

SPARE PARTS STAND	REF.	N
REAR STAND FOR SINGLE SWING ARM TRANSMISSION LEFT SIDE AXIS NOT INCLUDED	5332N	(*)
REAR STAND FOR SINGLE SWING ARM TRANSMISSION RIGHT SIDE AXIS NOT INCLUDED	5849N	(*)

AXIS SPARE	Ø	REF.	D
BMW	53 mm.	5518D	(*)
BMW	30,5 mm.	5557D	(*)
DUCATI	21,5 mm.	5513D	(*)
DUCATI	38,5 mm.	5897D	(*)
DUCATI	40,7 mm.	5517D	(*)
MV GUSTA	40,7 mm.	5517D	(*)
MV GUSTA	42,5 mm	7479D	(*)
HONDA	28,4 mm.	5515D	(*)
TRIUMPH	27,4 mm.	5516D	(*)
KTM	27,4 mm.	5516D	(*)

(*) Check price with your distributor.

IMPORTANT: Indicate code color after part#. Example: 0973A.

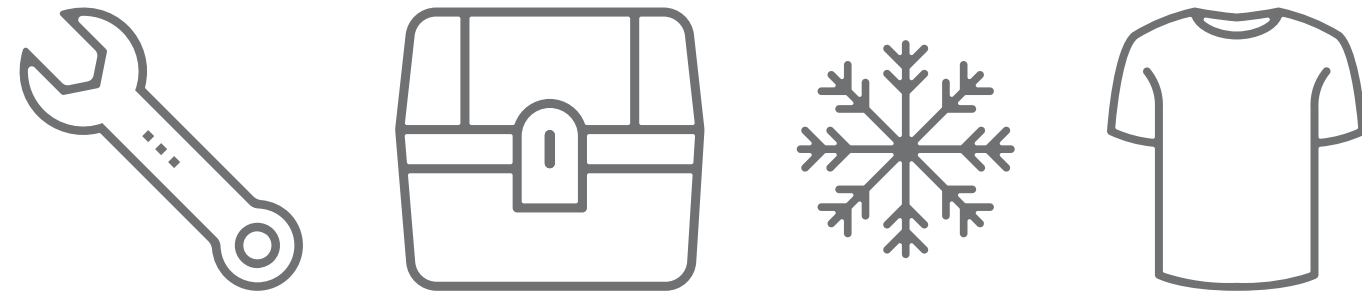

MAINTENANCE / WORKSHOP
TRUNKS
WINTER
MERCHANDISING

ANODIZED SCREWS KIT	525
BOX COVERS	529
DIGITAL TIRE PRESSURE INDICATOR	522
DIRTY OIL TANK AND BRUSH	521
ELASTIC NETS	523
FAIRING QUICK SCREWS	524
HEAT RESISTORS	531
HEATED GRIPS	531
KICKSTAND BASE SUPPORT	522
LEGS COVER MAXISCOOTER	530
LEGS COVER SCOOTER	530
MERCHANDISING	532
MOTORCYCLE WATERPROOF COVER	530
SCISSOR LIFT JACK	520
SILENTBLOCKS	524
SOFT AND SEMI-RIGID HAND GUARDS	531
SPIRAL TUBES	524
STRAPS	523
TIRE REPAIR KIT	522
TOP BOXES	526
TRIM-ENDING	524
WHEEL BALANCE STAND	520

MAINTENANCE

HI-TECH PARTS



// SCISSOR LIFT JACK

MODEL	REF.	R
SCISSOR LIFT JACK WITH ADAPTORS	5608R	(*)

DIMENSIONS: 48 x 15 cm.

WEIGHT: 15 kgs.

MAX. LOAD: 500 kgs. Maximum height: 45 cm.

With four lined rubber adaptors to support the tube frames and two adaptors for the adaptors.

ADAPTOR HEIGHTS: 5 cm and 10 cm

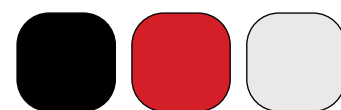

N
Black

R
Red

D
Anodized



// WHEEL BALANCE STAND

MODEL	REF.	N	D
WHEEL BALANCE STAND	5482N	(*)	
DUCATI ADAPTER DIMENSIONS 60 x 32 mm.	5974D	(*)	

(*) Check price with your distributor.

IMPORTANT: Indicate code color after part#. Example: 0973A.



// DIRTY OIL TANK AND BRUSH

MODEL	REF.	N	A
DIRTY OIL TANK 8L (600 x 320 x 135 mm.)	5260N	(*)	
BRUSH CLEANING CHAIN	5870A	(*)	



N
Black

A
Blue

(*) Check price with your distributor.

IMPORTANT: Indicate code color after part#. Example: 0973A.

ACCESSORIES
HI-TECH PARTS



// DIGITAL TIRE PRESSURE INDICATOR

MODEL	REF.	N
DIGITAL TIRE PRESSURE INDICATOR	5401N	(*)

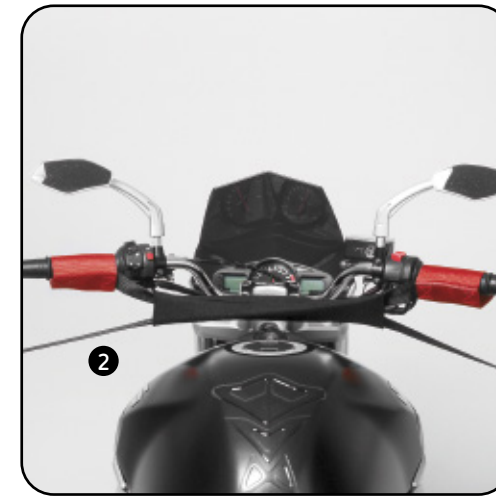

// STRAPS

MODEL	REF.	N
(1) TIE DOWN WITH HOOKS BY PAIR C/BLACK	6274N	(*)
(2) BAR STRAPS BY PAIR C/BLACK	4592N	(*)



// TIRE REPAIR KIT

MODEL	REF.	N
TIRE REPAIR KIT	5982N	(*)



// ELASTIC NETS

MODEL	REF.	PRICE
RED	0788	(*)

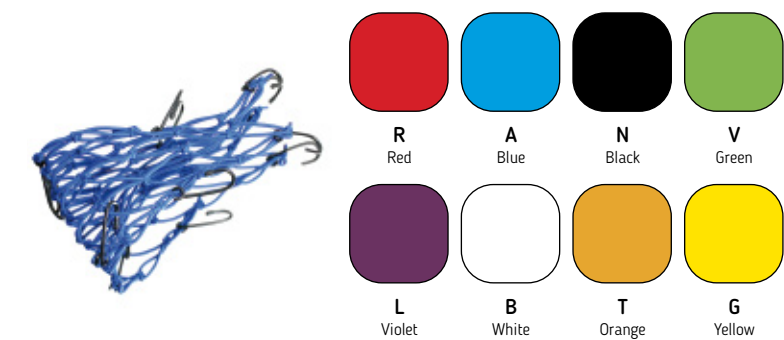

// KICKSTAND BASE SUPPORT

MODEL	REF.	N
BASE FOR KICKSTAND WITH BLACK DIAMETER 80 mm.	6335N	(*)

(*) Check price with your distributor.
IMPORTANT: Indicate code color after part#. Example: 0973A.

(*) Check price with your distributor.
IMPORTANT: Indicate code color after part#. Example: 0973A.

SPARES
HI-TECH PARTS

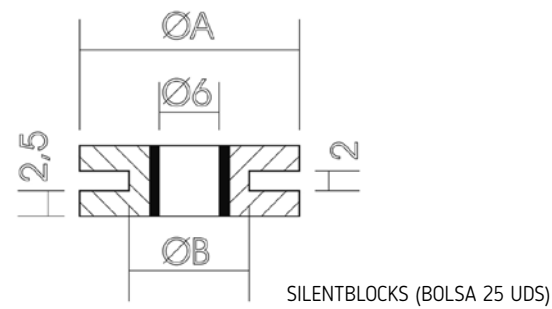

SILENTBLOCKS (BOLSA 25 UDS)

// SILENTBLOCKS

AxBxCxDxExG	REF.	N
22 x 12	1888N	(*)



// FAIRING QUICK SCREWS

MODEL	REF.	D
BLISTER 6 FAIRING QUICK SCREWS + BRACKETS	5484D	(*)



// SPIRAL TUBES

MODEL	REF.	G T L
ROLL OF 10 METERS	0892G	(*)
ROLL OF 10 METERS	0892L	(*)
ROLL OF 10 METERS	0892T	(*)

// TRIM-ENDING

O x I	COLOR	REF.	ROLLO	N H W
6,2 x 3,6 (1)	TRANSPARENT	4303W	200 mts.	(*)
6,2 x 3,6 (2)	SMOKE	4748H	200 mts.	(*)
3 x 1,5 (1)	BLACK	5590N	50 mts.	(*)
6 x 3 (1)	BLACK WITH ADHESIVE	0088N	25 mts.	(*)

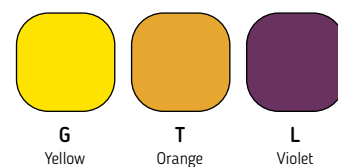
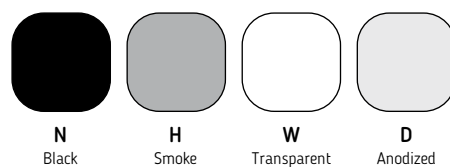

// ANODIZED SCREWS KIT



MODEL	REF.	R V A N L G P
BLISTER 6 ALLEN SCREWS M5 x 15 mm. (1)	0146	(*)
BLISTER 6 ALLEN SCREWS M5 x 20 mm. (1)	0147	(*)
BLISTER 6 ALLEN SCREWS M5 x 25 mm. (1)	0185	(*)
BLISTER 6 ALLEN SCREWS M6 x 15 mm. (1)	0363	(*)
BLISTER 6 ALLEN SCREWS M6 x 20 mm. (1)	0364	(*)
BLISTER 6 ALLEN SCREWS M6 x 25 mm. (1)	0544	(*)
BLISTER 6 ALLEN SCREWS M6 x 30 mm. (1)	0258	(*)
BLISTER 6 ALLEN SCREWS M6 x 35 mm. (1)	0346	(*)
BLISTER 6 ALLEN SCREWS M6 x 45 mm. (1)	0370	(*)
BLISTER 6 ALLEN SCREWS M6 x 50 mm. (1)	0421	(*)
BLISTER 6 ALLEN SCREWS M6 x 55 mm. (1)	0446	(*)
BLISTER 6 ALLEN SCREWS M8 x 30 mm. (1)	0473	(*)
BLISTER 6 ALLEN SCREWS M8 x 35 mm. (1)	0500	(*)
BLISTER 6 ALLEN SCREWS M8 x 45 mm. (1)	0516	(*)
BLISTER 6 ALLEN SCREWS M8 x 50 mm. (1)	0524	(*)

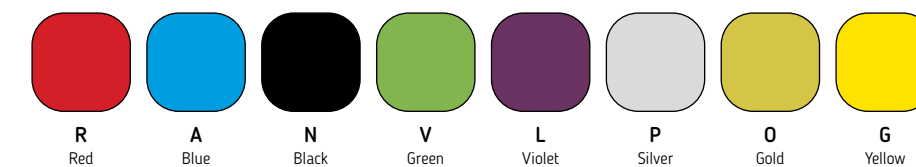

MODEL	REF.	R V A N L G P
BLISTER 6 ALLEN SCREWS M8 x 55 mm. (1)	0540	(*)
BLISTER 6 LOCK NUTS M5	0735	(*)
BLISTER 6 LOCK NUTS M6	0736	(*)
BLISTER 6 LOCK NUTS M8	0832	(*)
BLISTER 6 NUTS M5	0763	(*)
BLISTER 6 NUTS M6	0764	(*)
BLISTER 6 NUTS M8	0863	(*)
BLISTER 6 ALLEN HEAD IRON THREAD SCREWS M6 x 20 mm. (2)	2542	(*)
BLISTER 6 ALLEN HEAD IRON THREAD SCREWS M6 x 30 mm. (2)	2543	(*)
PLASTIC BOX (#) (LENGTH 300 x HEIGHT 30 x WIDTH 150)	3961W (#)	(*)

(#) With 32 departamentos. Delivered 6 screws each of the most common references.
IMPORTANT: Indicate code color after part#. Example: 0973A.

TOP BOXES
HI-TECH PARTS

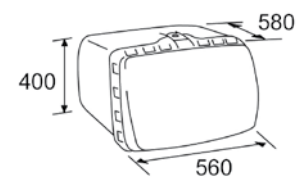

// MEGA BOX WITH LOCK

MODEL	REF.	MATERIAL	R N B
UNIVERSAL	2328	POLYPROPYLENE	(*)
METALLIC BASE	3506N		(*)
TRAY KIT (OPTIONAL)	3844N	ABS	(*)
SPARE HANDLER	3555N		(*)
SPARE LOCK	7548N		(*)

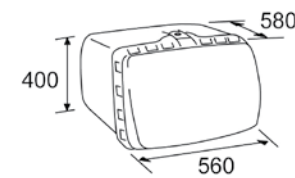
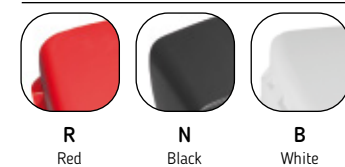

// MEGABOX KEYLESS LOCK

MODEL	REF.	MATERIAL	N B
UNIVERSAL	3108	POLYPROPYLENE	(*)
SPARE LOCK WITHOUT KEY	3092		(*)
METALLIC BASE	3506N		(*)
TRAY KIT (OPTIONAL)	3844N	ABS	(*)

(*) Check price with your distributor.
IMPORTANT: Indicate code color after part#. Example 0973A

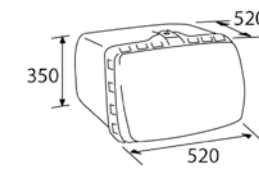

// MAXI BOX WITH LOCK AND FIXED WITH STRAPS

MODEL	REF.	MATERIAL	R N B
UNIVERSAL	3659	POLYPROPYLENE	(*)
STRAPS BY PAIR	3828		(*)
SPARE LOCK	7548N		(*)

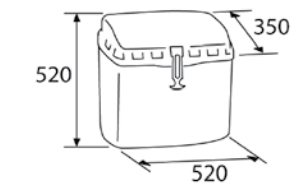
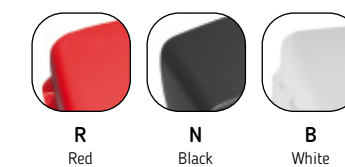

// MAXI BOX WITHOUT LOCK AND FIXED WITH STRAPS

MODEL	REF.	MATERIAL	R N B
UNIVERSAL	3660	POLYPROPYLENE	(*)
STRAPS BY PAIR	3828		(*)
SPARE LOCK WITHOUT KEY	3092N		(*)

(*) Check price with your distributor.
IMPORTANT: Indicate code color after part#. Example 0973A

TOP BOXES

HI-TECH PARTS

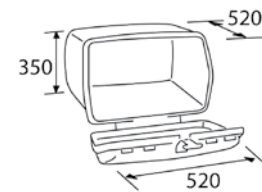
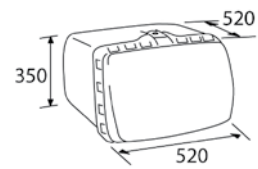

// MAXI BOX WITH LOCK WITH KEY

MODEL	REF.	MATERIAL	R	N	B
UNIVERSAL	0468	POLYPROPYLENE	(*)		
TRAY KIT (OPTIONAL)	1886N	ABS	(*)		
SPARE LOCK	7548N		(*)		
METALLIC BASE	9329N		(*)		
SQUARE HINGE	9851N		(*)		

// MAXI BOX WITH LOCK WITHOUT KEY

MODEL	REF.	MATERIAL	N	B
UNIVERSAL	1126	POLYPROPYLENE	(*)	
TRAY KIT (OPTIONAL)	1886N	ABS	(*)	
SPARE HANDLER	3601N		(*)	
METALLIC BASE	9329N		(*)	
SQUARE HINGE	9851N		(*)	
PIVOT	3808N		(*)	
SPARE LOCK WITHOUT KEY	3092N		(*)	

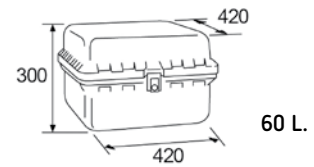

60 L.

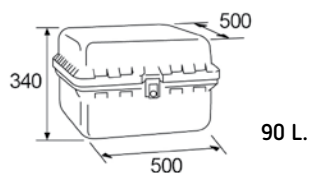

90 L.

// BIG BOX

MODEL	REF.	MATERIAL	R	N	B
UNIVERSAL 60L.	0390	POLYPROPYLENE	(*)		
UNIVERSAL 90L.	0713	POLYPROPYLENE	(*)		
SPARE LOCK	7548N		(*)		
SPARE SIDE LOCK	3192N		(*)		

BOX COVERS

HI-TECH PARTS



// THERMAL BAG

MODEL	REF.	R
THERMAL BAG 45 x 45 x 24 cm.	9250	(*)

OPTIMAL FOR MAXI BOX AND MEGA BOX TOB BOXES.

R
Red(*) Check price with your distributor.
IMPORTANT: Indicate code color after part#. Example: 0973A.



// LEGS COVER SCOOTER

MODEL	REF.	N
UNIVERSAL LEGS COVER RAINCOAT	5508N	(*)



// MOTORCYCLE WATERPROOF COVER

MODEL	REF.	P
SIZE S-L MOTORCYCLES <500 / SCOOTERS	5560P	(*)
SIZE XL-XXL MOTORCYCLES OF 600-1000CC	5152P	(*)



// LEGS COVER MAXISCOOTER

MODEL	REF.	N
UNIVERSAL LEGS COVER RAINCOAT	9749N	(*)



// HEATED GRIPS

MODEL	REF.	N
SET WITH HANDLES THERMOSTAT 22 mm.	5020N	(*)



// HEAT RESISTORS

MODEL	REF.	N
RESISTORS WITH THERMOSTAT FOR GRIPS BY PAIR	5930N	(*)



// SOFT AND SEMI-RIGID HAND GUARDS

MODEL	REF.	N
(1) UNIVERSAL SEMI-RIGID HAND GUARDS	6845N	(*)
(2) UNIVERSAL MOTO / SCOOTER HAND GUARDS	5486N	(*)
UNIVERSAL SCOOTER HAND GUARDS	3863N	(*)

(*) Check price with your distributor.
IMPORTANT: Indicate code color after part#. Example: 0973A.

(*) Check price with your distributor.
IMPORTANT: Indicate code color after part#. Example: 0973A.

MERCHANDISING
HI-TECH PARTS



// DISPLAY SCREENS

MODEL	REF.
DISPLAY SCREENS COLORS	1196R

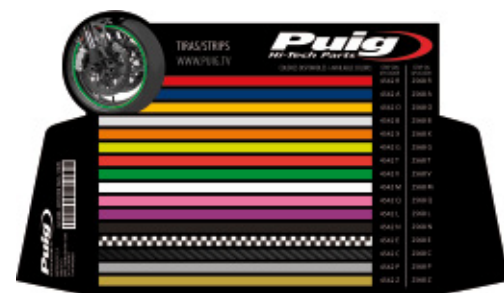

// DISPLAY STRIP

MODEL	REF.
STRIP COLOR DISPLAY	9180N



NEW!

// VISOR DISPLAY

MODEL	REF.	PRICE
VISOR DISPLAY	20497N	(*)



REF. 9665R

NEW!

REF. 20315N



// ANODIZED PIECES DISPLAY

MODEL	REF.	PRICE
DISPLAY LEVER + REAR MIRROR + BAR END + GRIP	9665R	(*)
DISPLAY LEVER 3.0	20315N	(*)



// HI-TECH PARTS DISPLAY

MODEL	REF.	PRICE
HI-TECH PARTS DISPLAY 854 x 1900 mm.	7324N	(*)

MERCHANDISING

HI-TECH PARTS



// CATALOG

MODEL	REF.
CATALOG 2021 SPANISH VERSION	9350N
CATALOG 2021 FRENCH VERSION	9351N
CATALOG 2021 ENGLISH VERSION	9352N
CATALOG 2021 GERMAN VERSION	3772N



// PUIG STICKERS

MODEL	REF.	PRICE
LARGE PUIG ADHESIVE 400 mm.	9348N	(*)
ADHESIVE PUIG MEDIUM 135 x 33 mm.	9349N	(*)



// FLAG

MODEL	REF.	PRICE
FLAG 200 x 90 cm. PUIG HI-TECH PARTS	3669N	(*)



NEW!

// FLASK

MODEL	REF.	PRICE
FLASK 500 ml.	20499N	(*)



// PEN / NOTEBOOK

MODEL	REF.	PRICE
PEN	9347N	(*)
NOTEBOOK	9312N	(*)



// METACRYLATE PUIG

MODEL	REF.	PRICE
METACRYLATE PUIG 680 x 300 x 3 mm.	2203B	(*)



RUG

MODEL	REF.	PRICE
RUG PUIG 2000 x 800 mm.	6362N	(*)

MANUFACTURED: 100% Nylon, non-slip and water resistant



// CLOCK

MODEL	REF.	PRICE
CLOCK PUIG HI-TECH PARTS Ø 30 cm.	9856N	(*)

MERCHANDISING

HI-TECH PARTS



// BUFF

MODEL	REF.	PRICE
BUFF PUIG	9345N	(*)



// BACKPACK

MODEL	REF.	PRICE
BACKPACK PUIG	9228N	(*)



NEW!

// HOODIE

MODEL	REF.	PRICE
SIZE XS	3746N	(*)
SIZE S	3747N	(*)
SIZE M	3748N	(*)
SIZE L	3749N	(*)
SIZE XL	3750N	(*)
SIZE XXL	3751N	(*)
SIZE XXXL	3752N	(*)



// MEN T-SHIRTS

MODEL	REF.	PRICE
SIZE S	4335N	(*)
SIZE M	4334N	(*)
SIZE L	4333N	(*)
SIZE XL	4332N	(*)
SIZE XXL	4336N	(*)
SIZE XXXL	9343N	(*)
SIZE XXXXL	9344N	(*)



// KEYCHAINS

MODEL	REF.	PRICE
KEYCHAIN WITH TAPE	9227N	(*)
KEY SUPPORT WITH ZIP CLOSURE	8120N	(*)



// CAP

MODEL	REF.	PRICE
CAP HI-TECH PARTS	9346N	(*)

// WOMAN T-SHIRTS

MODEL	REF.	PRICE
SIZE M	5177N	(*)

MERCHANDISING

HI-TECH PARTS



// JACKET SOFTSHELL

MODEL	REF.	PRICE
SIZE XS	9857N	(*)
SIZE S	9858N	(*)
SIZE M	9859N	(*)
SIZE L	9860N	(*)
SIZE XL	9861N	(*)
SIZE XXL	9862N	(*)
SIZE XXXL	9863N	(*)



NEW!

// MASK

MODEL	REF.	PRICE
ADJUSTABLE PUIG MASK	20498N	(*)

NOTES

www.puig.tv

A large area with horizontal lines for taking notes.

SALES CONDITIONS

- 1% extra discount sending the order through our extranet on www.puig.tv.

RETURN PROCEDURES

- No return will be accepted after 3 months from shipping note.
- The return must be accepted from Motoplastic S.A., after verification of the material by an agent in the area or, otherwise, through an email sent to pedidos@puig.tv requesting the return along with detailed images.
- If the return is not Motoplastic's fault, 20% devaluation will be applied and material will need to be sent paid for.
- If the return is because of the transport, the customer will need to send us the transporter's shipping note where should be noted, at the time of the reception of the cartons, the disagreement of the condition of the material. Additionally, images of the cartons in bad condition will need to be sent to us.

BRAND AND IMAGES

PUIG® is a registered brand.

The images from this catalog and site www.puig.tv are property of Motoplastic, S.A. and need authorization from Motoplastic, S.A. for its use.

Motoplastic, s.a. does not have any link with brands HONDA, YAMAHA, SUZUKI, KAWASAKI, APRILIA, BMW, BUELL, CAGIVA, DERBI, DUCATI, HYOSUNG, KTM, MV AGUSTA, PEUGEOT, TRIUMPH and others mentioned. All products registered brand, model or initials, are named with only purpose to cross reference with accessories of our own production.

2021 Motoplastic S.A. © All rights reserved.

HEADQUARTERS

MOTOPLASTIC, S.A.

Passeig de la Ribera, nº29

08403 Granollers

Spain

Tel. (+34) 938490633

Fax (+34) 938490988

info@puig.tv

UNITED STATES

PUIG USA INC.

3843 St. Valentine Way

Orlando, FL 32811

Ph. (+1) 407.237.0207

info@puigusa.com



W W W . P U I G . T V